



Mahatma Education Society's
Pillai College of Engineering
Dr. K. M. Vasudevan Pillai's Campus, New Panvel - 410206



ANNUAL REPORT

2020-2021





Table of Contents

From Principal's Desk	1
Acknowledgement	3
Introduction	5
Vision & Mission	5
Organization Structure	6
Board of Governance	7
Quality Assurance	8
Academic and Administrative Audit (AAA)	8
Perspective Plan 2019-2024	9
IQAC Initiatives	15
Academics	19
Programs Offered	19
Status of Admission	20
Results	21
Placements	22
Faculty	29
List of Faculty	29
List of faculty with Ph.D qualification	34
Research Publications by Faculty	37
Guest Lectures/ Seminars/Workshops/Webinars/FDPs organised by Departments	48
Department of Automobile and Mechanical Engineering	48
Department of Computer Engineering and Information Technology	91
Department of Electronics and Telecommunication Engineering and Electronics and Computer Science	107
Department of Applied Sciences, Mathematics and Humanities	126
Online Intra- College Debate Competition	141
Training and Placement Cell	146
Co-Curricular Activities	160
Learn Without Limits- Coursera Courses	160



National Programme on Technology Enhanced Learning (NPTEL)	161
Project Based Learning (PBL)	162
Spoken Tutorials	181
Internships	183
Deep Blue Season 6	184
ANUBHAV	188
Institution's Innovation Council	192
Student Chapter Activities	204
CSI	204
AESA-MESA	215
ISHRAE	221
IEEE	226
ETSA	230
SAE	240
VANGUARD Racing Team	243
Spark Racing Team	246
Hyperion Racing Team	248
TAPAS	251
NSS	257
SWE	266
Extra Curricular Activities	268
Independence Day	268
Teacher's Day	269
Dussehra	270
Drishti - The Unseen Vision	273
Republic Day	275
Utsav Majhya Rajanacha: Shivaji Jayanti	276
Alegria - The Festival of Joy	277
International Women's Day	282
Social Events	284
What's Next Post COVID	284



Garage Sale	286
Atma Nirbhar	286
Community Service Day	288
SANMATI 2021 – A webinar on Universal Human Values	291
Dog Feeding Drive	292
Workshop on Youth health and Mind Management	293
Unnat Bharat Abhiyan Activity	294
Notable Achievements	297
Toycathon 2021	297
Golden Jubilee Talk Series on “National Education Policy..... The Road Ahead”	302
National Web Conference - Global Competitiveness of Indian Mineral Industry	305
NAAC Approved National Webinar on ‘Assessment and Accreditation process of NAAC’	307
MoUs	312
Copyrights & Patents Received	313
Funding and Research Grants	314
Faculty Achievements	315



From Principal's Desk

Dear Readers,

Pillai College of Engineering (Erstwhile Pillai Institute of Information Technology until April 2016), established in 1999 under the patronage of Dr K M Vasudevan Pillai, is a reputed engineering college in Navi Mumbai. It is affiliated to the University of Mumbai, approved by All India Council for Technical Education (AICTE), New Delhi and is recognized by the Government of Maharashtra. PCE is one of the top colleges in India awarded A+ Grade by NAAC, ARIIA band B and a 5 star rating IIC Institute. The college has the enrollment of about 2700+ students in its 6 UG, 4 PG and 3 PhD research centers. The institute strives to provide state of the art facilities conducive to effective teaching-learning, research and consultancy. It further takes every effort in inculcating in the minds of students the respect for the environment. Faculty of PCE is very active in R & D and has completed projects for government agencies such as DST, BRNS, ICSSR and UGC. PCE is known for interdisciplinary centers for excellence, infrastructure, value added courses, job oriented training programs, project based learning and the annual cultural festival named ALEGRIA - Festival of Joy.

We take pride in bringing out this comprehensive report of the plethora of activities conducted since lockdown. We have made great strides in every aspect that an institution needs to focus on and the lockdown motivated us to make the best of the opportunities. When most of the world had stopped in the pandemic situation, our team was planning on self development and institutional growth, and since then there has been no looking back. We have transitioned to the online mode and participated in numerous events and were organizing a variety of events / seminars/ faculty development programs/ workshops and orientation programs with our own faculty as resource persons. Our outreach expanded beyond geographical boundaries and we could bring resourceful persons from all over India and abroad to participate in our programs. The lockdown in fact gave us a chance to conduct such a big number of activities as never imagined.

Some major activities and achievements are mentioned here. The institute has implemented Seventh Pay for its teaching faculty which was on its goal in the perspective plan. Awareness of the new education policy was created by organizing expert talks. The Electronics and Computer Science branch was added and also the intake of Computer Engineering was increased from 120 to 180. Six of PCE faculty members completed their Ph.D. Special Institute - Industry Talk series were organised by various departments to make the students industry ready as physical visits were not possible. As the mode of passing knowledge was changed from offline to online, PCE reached National and International experts and connected them to our students and faculty to share their knowledge. Two AICTE approved FDPs were also organised on an online mode. Various Value Added Courses, Quizzes, Workshops were initiated by faculty members to impart skills to the students so that they will be upgraded to meet the requirements of Industry 4.0. Around 2000+ students and faculty enrolled to 20000+ courses available in Coursera through the free registration made available to PCE students and faculties. Around 500+ students and faculty enrolled for IIT Bombay Spoken Tutorial FOSS Certification courses.



PCE Institute Innovation Council was recognized as a 5 Star Rating Institute by Govt. of India MoE Innovation Cell. PCE IIC also formed the committee to implement and monitor the National Innovation and Startup Policy (NISIP) to promote Innovation and startup in the institute. Six faculty members and four students were also recognized as Innovation Ambassadors by the MoE Innovation Cell. SWE PCE Affiliate was installed to empower women to achieve full potential in careers as engineers and leaders. Various social activities were carried out to help the people fighting the pandemic. PCE IIC was selected as a Nodal center to host the TOYCATHON 2021 in association with different Ministries under Government of India. Copyrights, patents, funded projects were sanctioned to the faculty members in various fields to strengthen the research culture of the institute.

I must congratulate all the faculty members who remained motivated and focused to organize and coordinate these events in spite of going through difficult times and wish all the best for better times ahead. We have made ourselves more visible than ever and now lies on us the responsibility of continuing with such activities for students and faculty members.

An engagement with Pillai College of Engineering will be an enriching experience for all our stakeholders. The years of higher education will prove vital to the professional growth of the youth. Our goal is to continue to prepare a future generation of engineers who are innovative leaders and creative problem solvers. PCE is committed to the utmost satisfaction of students, their parents and potential employers.

I am confident that with the contemporary education and strong moral values at PCE, our students will march ahead triumphantly to capture all glory and success in their professional, social as well personal life.



Acknowledgement

It gives us great pleasure and immense satisfaction to present the Annual Report of Pillai College of Engineering for the academic year 2020-21. The consistent growth of the institute seen in this report is possible due to the unstinted guidance and focused direction of **Dr. K M Vasudevan Pillai**, Honourable Chairman Mahatma Education Society, and **Dr. Priam Pillai**, Chief Operating Officer Mahatma Education Society.

Motivating guidance from **Dr P S Goyal** Dean R&D, administrative help from **Mr P Kumaran**, Registrar and untiring support by **Prof. Pragnesh Shah**, Director Admissions has always been the strength of PCE.

We express our sincere gratitude to respective head of the departments **Dr. Arun Pillai**, Applied Science Mathematics and Humanities, **Dr. Divya Padmanabhan**, Automobile Engineering, **Dr. Sharvari Govilkar**, Computer Engineering, **Dr. Rajendrakumar Khade**, Electronics Engineering, **Dr. Avinash Vaidya**, Electronics & Telecommunication Engineering and IIC Coordinator, **Dr. Satishkumar Varma**, Information Technology, **Dr. Dhanraj Tambuskar**, Mechanical Engineering, **Dr. Prashant Lokhande**, Training and Placement Officer, **Dr. Prashant Nitnaware**, PG and Ph.D Coordinator, **Dr. Manju Pillai** and **Dr. Sachin Wani**, Exam Cell Incharge.

We also express our sincere thanks to all **Criteria Incharges of NAAC** Dr. Rashed Ali, Prof. Jayshree B. Bhosale (C-1), Prof. Varunakshi Bhojane, Prof. Sonali Kathare, Prof. Rupali Nikhare (C-2), Dr. Satish Varma, Prof. Geeta Karmarkar (C-3), Dr Rashed Ali, Dr. Biswajit Panda (C-4), Prof. Apeksha Chavan, Prof. Payel Thakur (C-5), Prof. Amey Marathe , Prof. Rubina Shaikh (C-6), Dr. Richa Agrawal, Prof. Suchitra A. Patil (C-7) and their respective team members for timely response referring to data collection required for the compilation of the Annual Report.

We also acknowledge the contributions of student bodies and chapters namely **PCE Student Council** and it's Faculty Advisors Prof. Ranjita Gaonkar, Prof. Yogesh Kene, **IEEE** student members and Faculty Coordinator Prof. Padmaja Bangde, **ETSA** student members and Faculty Coordinator Prof. Apeksha Chavan, **ISHRAE** student members and Faculty Advisors Prof. Avinash Shaligram, Prof. Pruthviraj Rahane, **AESA-MESA** student members and Faculty Coordinators Dr. Onkar Sahastrabudhe, Prof. Amey Marathe, **Vanguard** Racing Team and Faculty Advisor Dr. Divya Padmanabhan, **Hyperion and Spark** Racing Team and Faculty Advisor Prof. Amey Marathe, **CSI and Hackathon** coordinator Prof. Varunakshi Bhojane, **TAPAS** team and Faculty Advisor Prof.



Madhura Vyawahare, **Deep Blue** Coordinator Prof. Aju Palleri, **NSS** program officers Prof. Bhagwan More, Prof. Archana Ingole and **Nature Club** Faculty Advisor Prof. Biswajit Panda.

We express our heartfelt gratitude to all PCE faculty members for their timely cooperation. Last, but not the least, we sincerely thank all our student chapter members, administrative staff and all others who have directly or indirectly contributed in making this Annual Report.

Last but not the least, a deep gratitude towards the dedicated efforts of **Dr. Richa Agrawal, Prof. Suchitra A. Patil, Prof. Deepti Nair** and **Prof. Madhura Vyawahare**, Annual Report Coordinators, as this report has seen the light of the day due to their sincere efforts.

Dr. Sandeep M. Joshi,

Principal,

Dr. Sharvari Govilkar and **Dr. Monika Bhagwat,**

IQAC Coordinators.



Introduction

Vision & Mission

Vision

Pillai College of Engineering (PCE) will admit, educate and train a diverse population of students who are academically prepared to benefit from the Institute's infrastructure and faculty experience, to become responsible professionals or entrepreneurs in a technical arena. It will further attract, develop and retain, dedicated, excellent teachers, scholars and professionals from diverse backgrounds whose work gives them knowledge beyond the classroom and who are committed to making a significant difference in the lives of their students and the community.

Mission

To develop professional engineers with respect for the environment and make them responsible citizens in technological development both from an Indian and global perspective. This objective is fulfilled through quality education, practical training and interaction with industries and social organizations.

Organization Structure

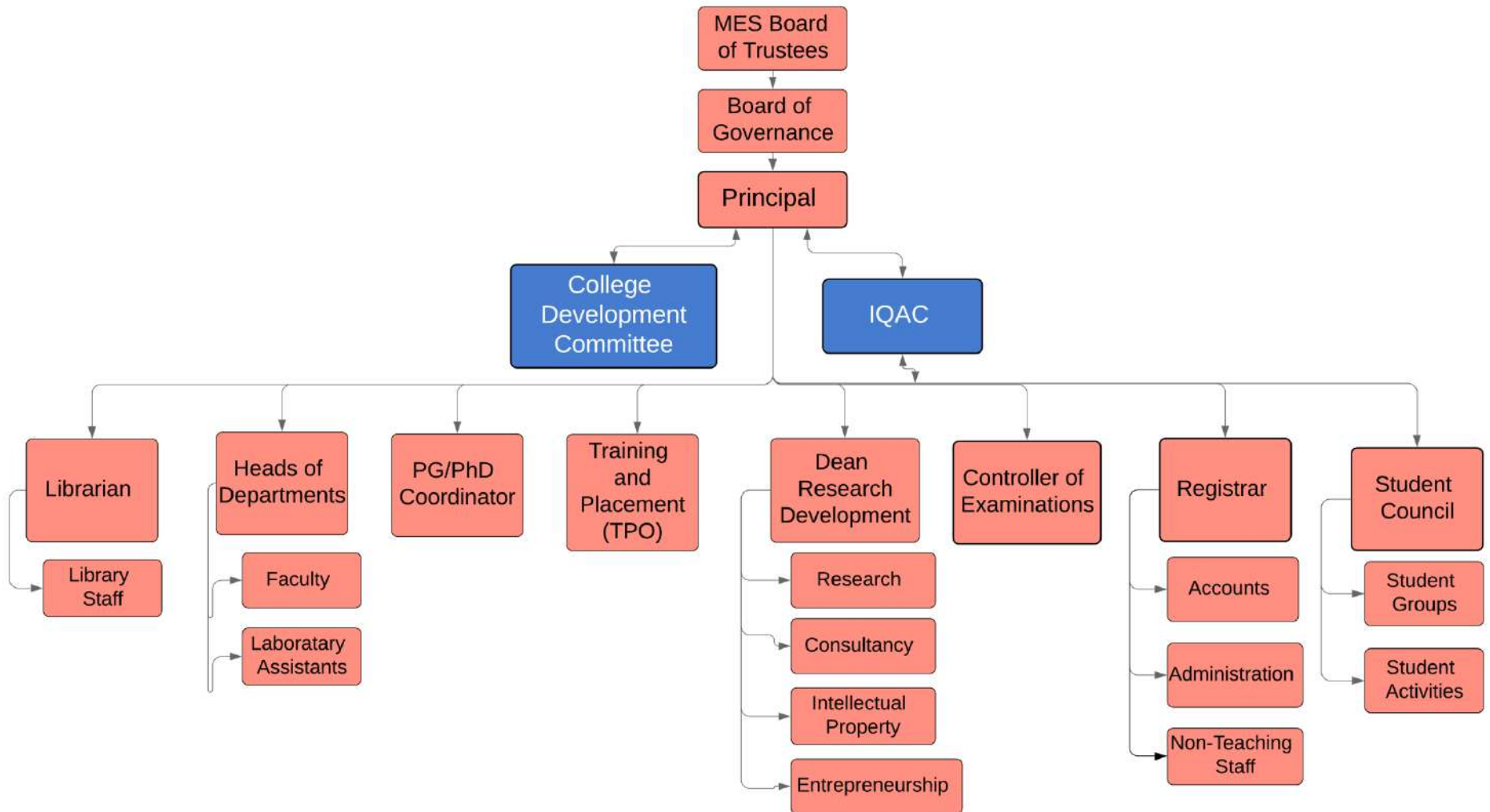

Pillai College of Engineering Organogram

Board of Governance

Name of the Member	Status of Committee Member
Dr. K.M. Vasudevan Pillai	Chairman
Dr. (Mrs) Daphne Pillai	Member
Dr. Priam V. Pillai	Member
Mr. Franav Pillai	Member
Prof. Munawira Pillai	Member
AICTE Representative	Member
DTE Representative	Member
University Representative	Member
Mr. Kamlesh Bafna	Member
Mr. Maruti Bapu Pawar	Member
Mr. Satish Shetty	Member
Mr. Sanjay Bishnoi	Member
Dr. M. Sasikumar	Member
Dr. Bernard Menezes	Member
Mr. Pramod Jadhav	Member
Mr. Pramod Sadarjoshi	Member
Mr. Tushar Pradhan	Member
Prof. P.S. Goyal	Member
Dr. Nivedita Shreyans	Member
Prof. Pragnesh N. Shah	Member
Dr. Sandeep M Joshi	Member Secretary

Quality Assurance

Academic and Administrative Audit (AAA)

Academic and Administrative Audit (AAA), are very essential for the excellence in Higher Education. These are interrelated concepts. Thus in order to have a quality oriented academic, there should be a strong administrative background.

Academic Audit - Academic audit can be understood as a scientific and systematic method of reviewing the quality of academic process in the institution. It is related with the quality assurance and enhancing the quality of academic activities in the institute.

Administrative Audit - It can be defined as a process of evaluating the efficiency and effectiveness of the administrative procedure. It includes assessment of policies, strategies & functions of the various administrative departments' control of the overall administrative system etc.

Objectives of AAA:

1. To understand the existing system and assess the strengths and weaknesses of the Departments and Administrative Units and to suggest the methods for quality improvement and for overcoming the weaknesses.
2. To identify the bottlenecks in the existing administrative mechanisms and to identify the opportunities for academic reforms, administrative reforms and examination reforms etc.

Perspective Plan 2019-2024

Strategic Goals and Implementation Plan

Goal 1: Improve Teaching Learning

1. More Industry Involvement in curriculum development
2. Regular External Academic Audits
3. More Add-On/Certificate/Skill Development courses to be offered to students
4. Additional content on Institute’s E-Learning Portal & encouragement of MOOCs and NPTEL
5. Increase utilization of E-resources in the library

Implementation Plan

Strategic Goal	2019-20	2020-21	2021-22	2022-23	2023-2024
Industry Involvement in Curriculum Development	Establish ad-hoc BoS for each department including industry experts	Implement add on courses prior to academic autonomy	Implement reformed curriculum with academic autonomy		
External Academic Audit	Academic Audit of Electronics and Electronics & Telecommunication Engg. Departments	Academic Audit of Mechanical & Automobile Engg. Departments.	Academic Audit of Computer Engineering and Informaton Technology Departments	Academic Audit of Electronics and Electronics & Telecommun ication Engg. Departments	Academic Audit of Mechanical and Automobile Engg. Deptartments
Add on Courses	20	30	50	50	50
Student certifications from NPTEL/edX, etc.	500	750	1000	1000	1000
Library E-Resources	Include literature review in curriculum in FE-PBL	Mandate use of institute E-resources for PG and PhD students		Review effectiveness of new policies	

Goal 2: Increase Research Impact

1. Start four new Centers of Excellence in Polymer Science, Web Data Mining and Cyber Security, Solar Radiation Data Center
2. Start PhD Center in Electronics Engineering
3. Encourage publications in quality journals

Implementation Plan

Strategic Goal	2019-20	2020-21	2021-22	2022-23	2023-2024
New Centers of Excellence	Appoint faculty in charge of new centers of excellence	Make budgetary provisions for each Center	Review and Monitor Progress of each center	Review and Monitor Progress of each center	Review and Monitor Progress of each center
PhD Center in Electronics Engineering	Apply to University of Mumbai for PhD center in Electronics Engineering	Start PhD course in Electronics Engineering	Review and Monitor Progress of center	Review and Monitor Progress of center	Review and Monitor Progress of center
Publications in Quality Journals	10 publications in high impact factor journals	20 publications in high impact factor journals	30 publications in high impact factor journals	30 publications in high impact factor journals	30 publications in high impact factor journals

Goal 3: Improve Training and Placement

1. Have job offers to 100% of graduating final year students
2. Have faculty develop industry relevant case studies for each course being taught
3. 100% of students to be engaged in internships during the 4 years

Implementation Plan

Strategic Goal	2019-20	2020-21	2021-22	2022-23	2023-2024
Job offers for 100% of final year students	50%	60%	75%	95%	100%
Industry relevant case studies for each course	10% of Courses	25% of Courses	50% of Courses	75% of Courses	100% of Courses
100% of Students engaged in internships	40% of Students	50% of Students	75% of Students	90% of Students	100% of Students

Goal 4: Technology Transfer to Industry

1. Increase IPR and Patents generated by the institute
2. Partner with Industries for student/research projects
3. Establish MOUs with Industries for technology IP sharing

Implementation Plan

Strategic Goal	2019-20	2020-21	2021-22	2022-23	2023-2024
Increase IPR and Patents generated by the institute	Establish IP committee to review patents submitted by faculty. Make budgetary provisions	3 patents	5 patents	10 patents	10 patents
Partner with Industries for student/research projects	20 Industry relevant Projects	30 Industry relevant Projects	40 Industry relevant Projects	50 Industry relevant Projects	50 Industry relevant Projects
Establish MOUs with Industries for technology IP sharing	5 IP related MOUs	10 IP related MOUs	10 IP related MOUs	10 IP related MOUs	10 IP related MOUs

Goal 5: Strengthen Alumni Engagement

1. Encourage all Alumni to follow the college on social media
2. Encourage Alumni to register on MES Alumni Platform
3. Improve PCE social media content
4. Increase the number of alumni events per year

Implementation Plan

Strategic Goal	2019-20	2020-21	2021-22	2022-23	2023-2024
Alumni to follow the college on social media	Share PCE alumni pages widely on social media and institute email lists				
Alumni to register on MES Alumni Platform	Publicize PCE Alumni platform on social media	1000 registrations	1500 registrations	3000 registrations	All Alumni registered
Improve PCE social media content	Appoint more students to monitor and update institute social media	2-4 posts per week on each page	5-10 posts per week	5-10 posts per week	5-10 posts per week
Number of alumni events per year	4	10	10	10	10

Goal 6: Have a greater impact on local community

1. Establish NSS
2. Increase the number of courses that incorporate environment and sustainability
3. Organize hackathons on various socially relevant topics
4. Adopt a local village
5. Organize a river side clean up drive
6. Increase Utilization of Renewable Sources of Energy

Implementation Plan

Strategic Goal	2019-20	2020-21	2021-22	2022-23	2023-2024
Establish NSS Unit	Apply to University to establish NSS unit	NSS conducts 2 events per year	Review NSS Activities	Review NSS Activities	Review NSS Activities
Number of courses that incorporate environment and sustainability	2	5	5	5	5
Organize hackathons on various socially relevant topics	1	2	2	2	2
Adopt a local village	Identify a local village to adopt and identify projects that the institute can initiate for that village	Initiate one Project	Monitor the implementation of Project 1 and start a new project.	Review effectiveness of new project. Extend further support to village when required	
Organize a river side clean up drive	Organize annual river side clean up drive. Appoint Faculty Coordinator	Organize annual river side clean up drive	Organize annual river side clean up drive	Organize annual river side clean up drive	Organize annual river side clean up drive
Decrease energy consumption and increase utilization of renewable energy resources	Switching to low energy consuming gadgets/fixtures	Initiate energy audit and identify the possibilities of reduced energy consumption	Enhance the capacity of existing Solar PV plant	Review effectiveness of the steps taken towards the goal	

Goal 7: To become an Autonomous Institute

1. Get NAAC accreditation
2. Get NBA accreditation of non-accredited departments
3. Establish department wise ad-hoc Boards of Studies to evaluate the curriculum
4. Increase stakeholder awareness about Autonomy
5. Apply to UGC for Autonomy

Implementation Plan

Strategic Goal	2019-20	2020-21	2021-22	2022-23	2023-2024
NAAC accreditation	Apply for NAAC accreditation	Become NAAC accredited			
NBA Accreditation	3	4	6	6	6
Department wise ad-hoc Boards of Studies	Establish Department wise ad-hoc Boards of studies	Review functioning of Boards of Studies	Convert ad-hoc BoS into BoS	Review functioning of Boards of Studies	Review functioning of Boards of Studies
Stakeholder Awareness about Autonomy	Conduct 3-4 workshops on autonomy	Incorporate Autonomy related information on website	-	-	-
Apply to UGC for Autonomy	Preparation for Autonomy	Apply to UGC	Become Autonomous Institute		

Goal 8: Augment Institutional Income

1. Rent out facilities (classrooms, labs) to various Government and Private bodies for the conduct of examinations during holidays
2. Increase the amount of consultancy to the institute

Implementation Plan

Strategic Goal	2019-20	2020-21	2021-22	2022-23	2023-2024
Rent out facilities (classrooms, labs)	Identify facilities that can be rented out such as computer labs, seminar halls etc	Advertise the availability of resources to various agencies and companies	No of rentals days 30	No of rentals days 50	No of rentals days 100
No of Consulting Projects	20	40	60	80	100

Goal 9: Introduce 7th Pay Commission

1. Conduct financial analysis of the impact of 7th pay commission
2. Apply for increase in student fees

Implementation Plan

Strategic Goal	2019-20	2020-21	2021-22	2022-23	2023-2024
Financial analysis of the impact of 7 th pay commission	Financial Analysis and Budgetary Provisions	Implement 7 th Pay Commission			
Increase in Student Fees	Apply for Increase in approved student fees	Apply for Increase in approved student fees	Apply for Increase in approved student fees	Apply for Increase in approved student fees	

Goal 10: Automate More Administrative Tasks

1. Automate tracking of NAAC and NBA related documentation
2. Further upgrade Mentor and Mentee Portal (ASK Portal)

Implementation Plan

Strategic Goal	2019-20	2020-21	2021-22	2022-23	2023-2024
Automate tracking of NAAC and NBA related documentation	Fully Automate online PBAS to capture NAAC and NBA documentation		Add any NAAC and NBA criteria	Add any NAAC and NBA criteria	Add any NAAC and NBA criteria
Further upgrade Mentor and Mentee Portal	Update Mentor and Mentee portal to track placement and Higher education data		Review Portal	Review Portal	Review Portal

IQAC Initiatives

SN	Name of Activity	Date	Speakers
1	NAAC Approved National Level Webinar on “Assessment and Accreditation process of NAAC”	28 th August, 2020	Dr. Ganesh Anant Hegde, Adviser, NAAC. Dr. Leena Govind Gahane, Deputy Adviser, NAAC. Dr. A V Prasad, Assistant Adviser, NAAC. Dr. N. R. Mohan, Assistant Adviser, NAAC.
2	Golden Jubilee Talk Series on “National Education Policy..... The Road Ahead”	28 th October, 2020	Dr. R Manoj Kumar, Joint Secretary, UGC.
3	National Level webinar on "The First Step in Improving Engineering Education in India: AICTEs New Rules for Admission and Eligibility"	14 th March, 2021	Dr. Priam Pillai, Chief Operating Officer, MES

National Level webinar on
"The First Step in Improving Engineering Education in India: AICTE's New Rules for Admission and Eligibility"

The Internal Quality Assurance Cell of Pillai College of Engineering organized a National Level Webinar on "The First Step towards Improving Engineering Education in India: AICTE's New Rules for Admission and Eligibility" on 14th March, 2021 at 5.00 pm. The expert for the Webinar was, Dr. Priam Pillai, Chief Operating Officer, MES. The Webinar was a much required discussion with respect to AICTE's courageous move to make basic science subjects like Physics, Chemistry and Mathematics as optional at class XII- level. Is it was, Expansion of choices??? Will it impact the quality of engineers produced in the country????... All such and similar queries were addressed by the speaker. The discussion helped the listeners understand that it was a small step which will eventually bring a big change in technical education in India. The talk was also broadcasted live over MES YouTube Channel. All the attendees actively participated in the discussion. The talk concluded with Vote of Thanks to the Speaker, Management PCE, Principal PCE, Organising Committee and the participants.



Mahatma Education Society's
PILLAI COLLEGE OF ENGINEERING, NEW PANVEL
Accredited by NAAC with A+ grade



Internal Quality Assurance Cell
presents
National Level Webinar on
The First Step Towards Improving Engineering Education in India:
AICTE's New Rules for Admission and Eligibility



Perspectives in Technical Education by
Dr. Priam Pillai
Chief Operating Officer, Mahatma Education Society



Click to Join



Sunday
14th March, 2021
5.00 pm

Pictures with proper caption:

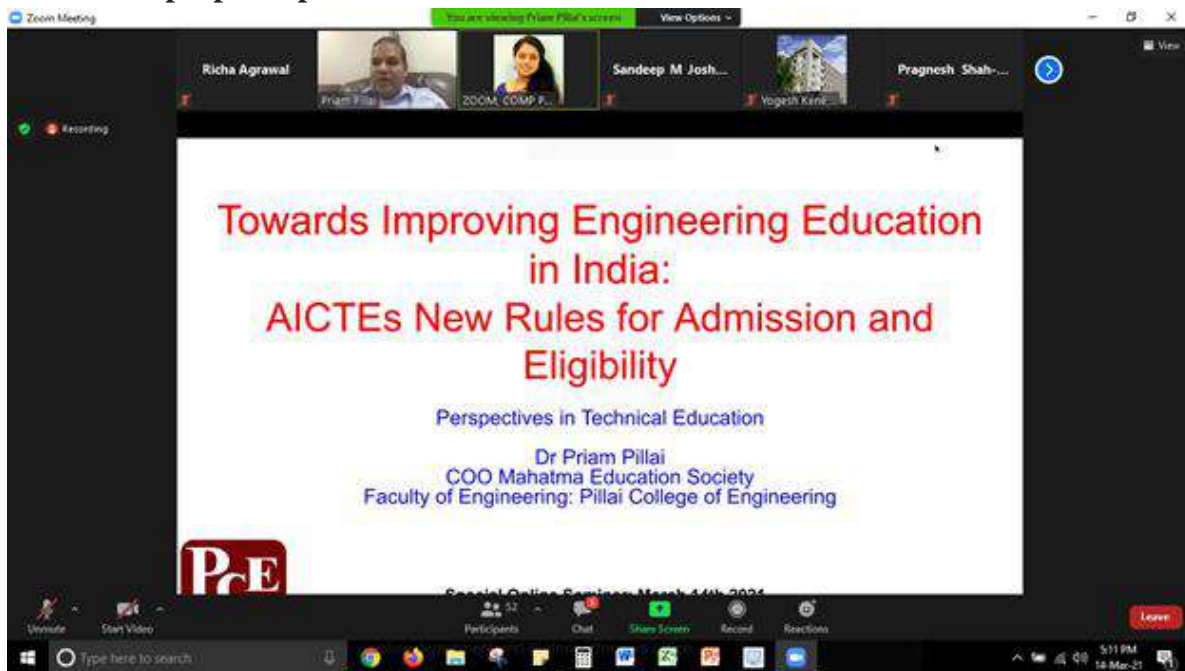

Talk by Dr. Priam Pillai



Q&A Session By Dr. Monika Bhagwat

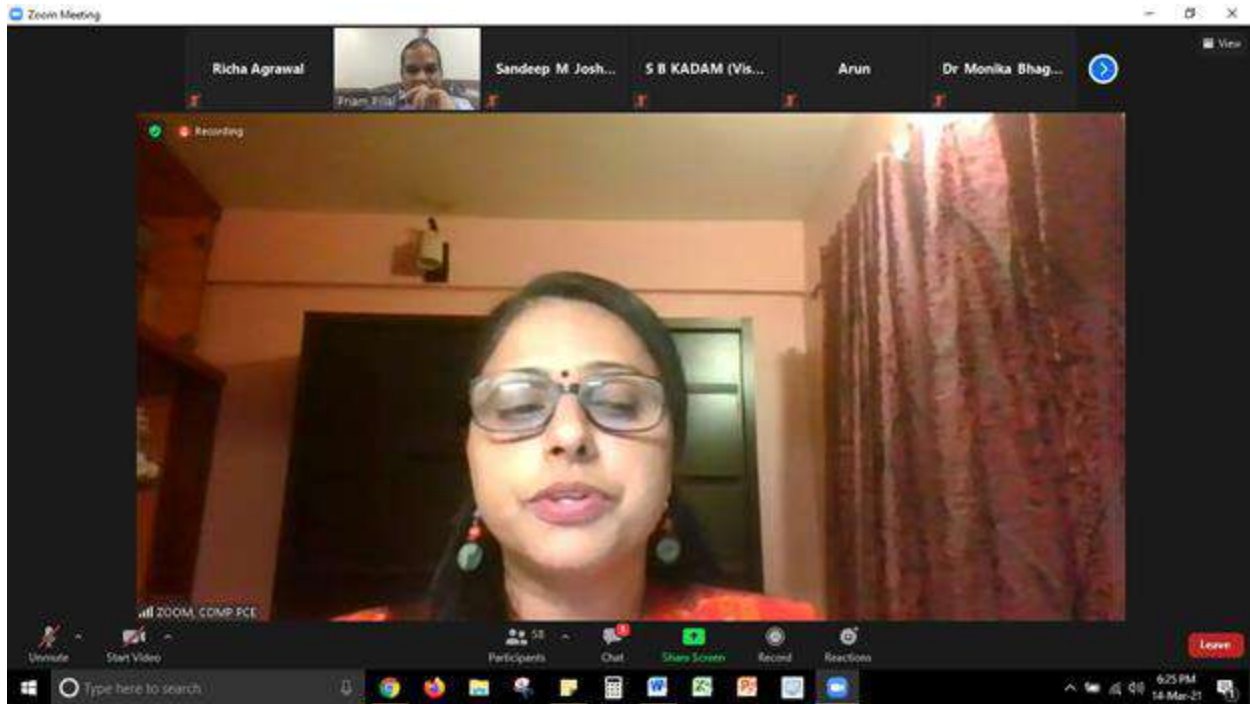

Vote of Thanks by Dr. Sharvari Govilkar

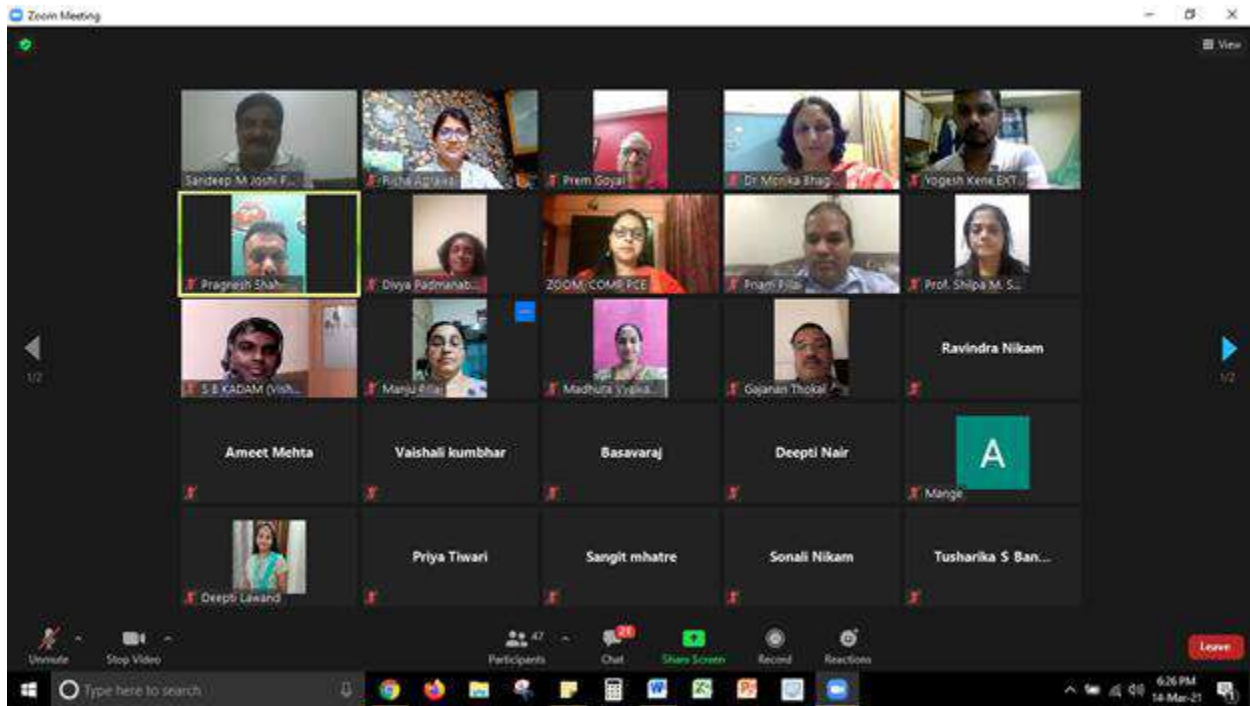

Group Snapshot of Participants with the Speaker

Academics

Programs Offered

Bachelor of Engineering, Master of Engineering and Ph.D. Programs

Degree	Courses	Year of Establishment	Sanctioned Strength
BE	1. Computer Engineering 2. Information Technology 3. Electronics & Computer Science 4. Mechanical Engineering 5. Electronics and Telecommunication Engineering 6. Automobile Engineering	1999 1999 1999 2002 2007 2009	180 120 90 120 120 60
ME	1. Information Technology 2. Mechanical Engineering CAD/CAM & Robotics 3. Computer Engineering 4. Electronics Engineering 5. Mechanical Engineering Thermal Engineering	2008 2008 2009 2009 2011	18 18 18 18 18
Ph.D	1. Computer Engineering 2. Mechanical Engineering 3. Information Technology	2017 2017 2019	10 10 10

Status of Admission

Programme Name	Number of Seats Sanctioned	Number of Students Admitted
Automobile Engineering	60	27
Computer Engineering	180	191
Electronics and Computer Science	90	81
Electronics and Telecommunication Engineering	120	67
Information Technology	120	120
Mechanical Engineering	120	66
Computer Engineering (PG)	18	3
Electronics Engineering (PG)	18	2
Information Technology (PG)	18	0
Mechanical Engineering (PG) – CAD/CAM & Robotics	18	7
Mechanical Engineering (PG) – Thermal Engineering	18	5
Computer Engineering(PhD)	10	9
Mechanical Engineering(PhD)	10	9
Information Technology (PG)	10	4

Results

SEM VIII Results - May 2020

Sn	Branch	Students Appeared	Students Passed	Pass %
1	Automobile Engineering	69	69	100%
2	Computer Engineering	152	152	100%
3	Electronics Engineering	71	71	100%
4	Electronics and Telecommunication Engineering	136	136	100%
5	Information Technology	145	145	100%
6	Mechanical Engineering	111	111	100%

Placements

Sr. No.	Branch	No of students placed
1	Automobile Engineering	09
2	Computer Engineering	70
3	Electronics Engineering	20
4	Electronics and Telecommunication Engineering	39
5	Information Technology	72
6	Mechanical Engineering	14
	Total	224

List of students placed 2020 Batch

Sr No	Name	Branch	Company
1	Dalvi Ballal Vitthal	Automobile Engineering	Lixil Window Systems Pvt. Ltd.
2	Garje Mayur Rajendra	Automobile Engineering	Lixil Window Systems Pvt. Ltd.
3	Kotian Roshan Dhananjay	Automobile Engineering	Lixil Window Systems Pvt. Ltd.
4	Shridhar Sahu	Automobile Engineering	Jyotitech
5	Naman Singh	Automobile Engineering	Jyotitech
6	Vijay Sharma	Automobile Engineering	Jyotitech
7	Madhav Gadhia	Automobile Engineering	Jyotitech
8	Saurabh Bhor	Automobile Engineering	Jyotitech
9	Aniruddh Gosavi	Automobile Engineering	Andrate Motors
10	Shinde Sushant	Computer Engineering	Ingram Micro
11	Rohit Haridas	Computer Engineering	Xoriant
12	Omkar Kumbhar	Computer Engineering	Mitr Learning and Media Pvt. Ltd
13	Chanan Kumar	Computer Engineering	Xoriant
14	Dhruv Patel	Computer Engineering	Persistent
15	Kimaya Dhanawade	Computer Engineering	Persistent
16	Rhaturaj Manohar Takle	Computer Engineering	Mitr Learning & Media
17	Pankaj Kumar	Computer Engineering	Persistent
18	Rajiv Ranjan	Computer Engineering	Maharashtra Knowledge Corporation Ltd
19	Neha Patil	Computer Engineering	Capgemini
20	Vivek Gupta	Computer Engineering	Sogosurvey
21	Gauresh Kale	Computer Engineering	JARO EDUCATION
22	Rahul Nair	Computer Engineering	Jio Platforms

23	Amol Mangesh Adarkar	Computer Engineering	Jio Platforms
24	Shreya Vettiyaatil	Computer Engineering	Jio Platforms
25	Aditya Maheshwari	Computer Engineering	Strategic Research
26	Manali More	Computer Engineering	GEP
27	Anupama Rai	Computer Engineering	GEP
28	Yash Shah	Computer Engineering	GEP
29	Sadashiv Shinde	Computer Engineering	GEP
30	Adukathil Arjun	Computer Engineering	L&T Infotech
31	Sayali Rajiv Bhambure	Computer Engineering	L&T Infotech
32	Shweta Jaganath Naidu	Computer Engineering	Capgemini
33	Neetisha Uniyal	Computer Engineering	L&T Infotech
34	Neha Vitthal Gharat	Computer Engineering	L&T Infotech
35	Omshree Shetty	Computer Engineering	L&T Infotech
36	Muskan Goyal	Computer Engineering	L&T Infotech
37	Mandar Mhatre	Computer Engineering	GEP
38	Ajaykumar Premkumar Nair	Computer Engineering	CAPGEMINI
39	Harish Unnikrishnan Nair	Computer Engineering	CAPGEMINI
40	Aditi Kashinath Deolekar	Computer Engineering	CAPGEMINI
41	Vani Balachandran Nair	Computer Engineering	CAPGEMINI
42	Nikhil Lalkrishna Tiwari	Computer Engineering	CAPGEMINI
43	Navpreet Singh Ranjit Singh Aulakh	Computer Engineering	CAPGEMINI
44	Ramneet Singh Aulakh	Computer Engineering	CAPGEMINI
45	Sreejish Krishna	Computer Engineering	CAPGEMINI
46	Hrishikesh Shashikumar Nair	Computer Engineering	CAPGEMINI
47	Sanjeet Shashank Bodkhe	Computer Engineering	CAPGEMINI
48	Resmi Ramakrishnan	Computer Engineering	CAPGEMINI
49	Smriti Sushil Kumar Sharma	Computer Engineering	CAPGEMINI
50	Sarah Shaikat Khalife	Computer Engineering	CAPGEMINI
51	Jeetan Rajesh	Computer Engineering	CAPGEMINI
52	Aditya Padmajan Nair	Computer Engineering	CAPGEMINI
53	Rashmi Singh	Computer Engineering	CAPGEMINI
54	Gokul Satheesan Chathankulam	Computer Engineering	CAPGEMINI
55	Dhrupad Umesh Joshi	Computer Engineering	CAPGEMINI
56	Amal Manoj Pillai	Computer Engineering	CAPGEMINI
57	Chitleen Mohapatra	Computer Engineering	CAPGEMINI
58	Parth Murali Nair	Computer Engineering	CAPGEMINI
59	Santwana Satish	Computer Engineering	CAPGEMINI
60	Shivani Pawar	Computer Engineering	Ugam Solutions
61	Mathew Jobi Joy	Computer Engineering	Ugam Solutions
62	Nithin Reshith	Computer Engineering	Ugam Solutions
63	Rutuja Pujare	Computer Engineering	TCS Ninja

64	Shalwin Rajan George	Computer Engineering	TCS Ninja
65	Simrandeep Kaur Sandhu	Computer Engineering	TCS Ninja
66	Bhor Shubham	Computer Engineering	TCS Ninja
67	Atharv Pillai	Computer Engineering	TCS Ninja
68	Asmita Bagal	Computer Engineering	Endurance International Group
69	Himanshu Keshri	Computer Engineering	QSpider
70	Aakash Vidhate	Computer Engineering	CRMNext
71	Saiprasad Agganuru	Computer Engineering	CRMNext
72	Shruthi Balan	Computer Engineering	Ugam Solutions
73	Radhika Dhopeswarkar	Computer Engineering	LTI through ICC
74	Saurabh Pahwa	Computer Engineering	LTI through ICC
75	Shriyansh Pradip Chakraborty	Computer Engineering	Newgen
76	Akansha Sudhir Verma	Computer Engineering	Minecraft
77	Sreelakshmi Kartha	Computer Engineering	Accenture
78	Romax Rajeev	Computer Engineering	Persistent
79	Vivek Vaishya	Computer Engineering	TCS Digital
80	Sonali Chavan	Electronics Engineering	TCS Ninja
81	Ram S Biyani	Electronics Engineering	TietoEVRY
82	Chavan Sonali	Electronics Engineering	LTI through ICC
83	Shubham Sharma	Electronics Engineering	Ekeeda
84	Gurpreet Singh Saini	Electronics Engineering	Ekeeda
85	Rohan Sharma	Electronics Engineering	Ekeeda
86	Bhavesh Agnihotri	Electronics Engineering	Ekeeda
87	Prashant Borade	Electronics Engineering	Ekeeda
88	Divesh Chawan	Electronics Engineering	Ekeeda
89	Ritik Dhama	Electronics Engineering	Ekeeda
90	Avdhut Dhole	Electronics Engineering	Ekeeda
91	Prajakta Gamit	Electronics Engineering	Ekeeda
92	Anmol Sharma	Electronics Engineering	JARO EDUCATION
93	Shivangi Singh	Electronics Engineering	L&T Infotech
94	Pallavi Krishnaji Kothavale	Electronics Engineering	CAPGEMINI
95	Nidhi Falak	Electronics Engineering	TCS Ninja
96	Bhavesh Agnihotri	Electronics Engineering	TCS Ninja
97	Mithun Mohan	Electronics Engineering	TCS Ninja
98	Shivshankar Mulage	Electronics Engineering	TCS Ninja
99	Shivam More	Electronics Engineering	TCS Ninja
100	Shivendra Arvind Sharma	Electronics and Telecommunication	Jio Platforms
101	Chaithra Lal Nair	Electronics and Telecommunication	CAPGEMINI
102	Anannya Mahapatra	Electronics and Telecommunication	CAPGEMINI
103	Sanidha Meghasham Hadkar	Electronics and Telecommunication	CAPGEMINI
104	Prathamesh Shailesh Damle	Electronics and	CAPGEMINI

		Telecommunication	
105	Arya Ramesh Patil	Electronics and Telecommunication	CAPGEMINI
106	Shivasish Debashis Sanyal	Electronics and Telecommunication	CAPGEMINI
107	Sahil Sanjay Shetye	Electronics and Telecommunication	CAPGEMINI
108	Jhansi Neha Pachipulusu	Electronics and Telecommunication	CAPGEMINI
109	Sarthak Deshmukh	Electronics and Telecommunication	Ugam Solutions
110	Nidhi Krishnan Nair	Electronics and Telecommunication	Ugam Solutions
111	Prajapati Archana	Electronics and Telecommunication	TCS Ninja
112	Janhavi Kharmale	Electronics and Telecommunication	TCS Ninja
113	Sandhya Yadav	Electronics and Telecommunication	TCS Ninja
114	Abhijit Satpute	Electronics and Telecommunication	TCS Ninja
115	Vedant Kandalgaonkar	Electronics and Telecommunication	TCS Ninja
116	Sakshi Kadam	Electronics and Telecommunication	TCS Ninja
117	Kaushal Patil	Electronics and Telecommunication	TCS Ninja
118	Saurabh Poman	Electronics and Telecommunication	TCS Ninja
119	Abhilasha Shinde	Electronics and Telecommunication	Endurance International Group
120	Tarun Shetty	Electronics and Telecommunication	QSpider
121	Shivendra Pandey	Electronics and Telecommunication	QSpider
122	Sagar Dedhia	Electronics and Telecommunication	QSpider
123	Divya Wairkar	Electronics and Telecommunication	QSpider
124	Rohan Darji	Electronics and Telecommunication	QSpider
125	Ankita Rajesh Kumar	Electronics and Telecommunication	CRMNext
126	Prajakta Ravindra Shinde	Electronics and Telecommunication	Capgemini
127	Shruti Bhosale	Electronics and Telecommunication	Capgemini
128	Gadage Prajakta	Electronics and	Capgemini

		Telecommunication	
129	Suraj Kumar B. Maiti	Electronics and Telecommunication	Mindtree
130	Mitali Shinde	Electronics and Telecommunication	Vistaar
131	Yashasvi Sanjay Pawar	Electronics and Telecommunication	Capgemini
132	Zaid Khan	Electronics and Telecommunication	Ugam Solutions
133	Deepak Surendra Jha	Electronics and Telecommunication	Ugam Solutions
134	Shrish R Singh	Electronics and Telecommunication	Ugam Solutions
135	Abhay Premkumar Nair	Electronics and Telecommunication	Capgemini
136	Jinisha Jain	Electronics and Telecommunication	Sogosurvey
137	Niriksha Poojari	Electronics and Telecommunication	Relianec Jio Platforms
138	Sayali Sangare	Electronics and Telecommunication	Accenture
139	Amruta Khavase	Information Technology	JARO EDUCATION
140	Ria Singh	Information Technology	Jio Platforms
141	Siddhesh Pawar	Information Technology	Jio Platforms
142	Ankit Gupta	Information Technology	GEP
143	Rucha Ghatugade	Information Technology	GEP
144	Mohammed Sameel Shaikh	Information Technology	GEP
145	Ipsita Sudhir Behera	Information Technology	L&T Infotech
146	Prince Zalavadia	Information Technology	L&T Infotech
147	Preetam B.A.	Information Technology	L&T Infotech
148	Vijay Sagar Sekar	Information Technology	L&T Infotech
149	Garima Singh	Information Technology	L&T Infotech
150	Varsha Verma	Information Technology	L&T Infotech
151	Harshada Pravin Shinde	Information Technology	CAPGEMINI
152	Ashok Rustam Singh	Information Technology	CAPGEMINI
153	Anjali Subhash Agarwal	Information Technology	CAPGEMINI
154	Aditya Ganesh Mhatre	Information Technology	CAPGEMINI
155	Ankita Anand Arondekar	Information Technology	CAPGEMINI
156	Mayur Laxman Dabade	Information Technology	CAPGEMINI
157	Manthan Gharat	Information Technology	CAPGEMINI
158	Neha Vinod Shahu	Information Technology	CAPGEMINI
159	Amogh Suresh Amin	Information Technology	CAPGEMINI
160	Shreyas Gangadhara Shetty	Information Technology	CAPGEMINI
161	Nishita Harishankar Chaudhary	Information Technology	CAPGEMINI
162	Akansh Vinod Shetty	Information Technology	CAPGEMINI
163	Pooja Prakash Mandavkar	Information Technology	CAPGEMINI

164	Yogitha Yashavant Nilekani	Information Technology	CAPGEMINI
165	Kinjal Baliram Sapkal	Information Technology	Ugam Solutions
166	Snehal Jadhav	Information Technology	TCS Ninja
167	Ruthvik Arun Shetty	Information Technology	TCS Ninja
168	Samruddhi Deshmukh	Information Technology	TCS Ninja
169	Shillare Abhishek	Information Technology	TCS Ninja
170	Rajkumar Vishwakarma	Information Technology	TCS Ninja
171	Kothari Anurag	Information Technology	TCS Ninja
172	Aditi Rathore	Information Technology	TCS Ninja
173	Harsh Jain	Information Technology	TCS Ninja
174	Utkarsha Talele	Information Technology	TCS Ninja
175	Abdullah Sarguroh	Information Technology	TCS Ninja
176	Aayushi Tiwari	Information Technology	TietoEVRY
177	Adarsh Kanekar	Information Technology	TietoEVRY
178	Anurag Kothari	Information Technology	TietoEVRY
179	Midhun VM	Information Technology	TietoEVRY
180	Aashna Oberoi	Information Technology	QSpider
181	Shradha Sherigar	Information Technology	QSpider
182	Tejas Kadam	Information Technology	QSpider
183	Ganesh Dash	Information Technology	QSpider
184	Rohini Subhash Pimparkar	Information Technology	Ingram Micro
185	Virag Savaliya	Information Technology	Ingram Micro
186	Verma Shreya Saloni	Information Technology	Ingram Micro
187	Mahendra Tikambhai Sutar	Information Technology	Neosoft Technologies
188	Paritosh Dhotre	Information Technology	Neosoft Technologies
189	Jyotsana Rawat	Information Technology	Neosoft Technologies
190	Janhavi Pawar	Information Technology	CRMNext
191	Ajay Prajapati	Information Technology	Ugam Solutions
192	Sharanya Menon	Information Technology	LTI through ICC
193	Yogesh Choudhary	Information Technology	LTI through ICC
194	Amruta Pradeep Bhosale	Information Technology	Mirraw
195	Modhe Shubham	Information Technology	Newgen
196	Yugabdh Pashte	Information Technology	Newgen
197	Shivani Sharad Shirke	Information Technology	Newgen
198	Vaidhai Kabir	Information Technology	Infosys
199	Ashutosh Darekar	Information Technology	Acidaes Solutions Pvt. Ltd.
200	Gaurav Kadam	Information Technology	Accenture
201	Soni Ganesh	Information Technology	Accenture
202	Adarsh Mishra	Information Technology	Accenture
203	Dnyaneshwari Vijay Shinde	Information Technology	Capgemini
204	Nehal Shinde	Information Technology	Persistent
205	Ronak Kothari	Information Technology	Persistent
206	Prathmesh Godse	Information Technology	Persistent
207	Ritu Deshmukh	Information Technology	Sankey Solutions
208	Ganesh Soni	Information Technology	Xoriant
209	Nikita Umredkar	Information Technology	Servosys Solutions

210	Aishwarya Patil	Information Technology	Sankey Solutions
211	Akshay Gangadharan	Mechanical Engineering	Keystone
212	Akshay Nair	Mechanical Engineering	QSpider
213	Pawar Pranali Shrikant	Mechanical Engineering	Lixil Window Systems Private Limited
214	Prathamesh Andalkar	Mechanical Engineering	Jyotitech
215	Kalawe Mazhar Faiyaz	Mechanical Engineering	Jyotitech
216	Durgesh Pawar	Mechanical Engineering	Jyotitech
217	Jay Ashodiya	Mechanical Engineering	Jyotitech
218	Omkar Sudam Patil	Mechanical Engineering	Jyotitech
219	Sahibole Dilawar	Mechanical Engineering	Jyotitech
220	Sarvesh Wadkar	Mechanical Engineering	Jyotitech
221	Prashant Patil	Mechanical Engineering	Jyotitech
222	Muskan Kazi	Mechanical Engineering	JARO EDUCATION
223	Prathmesh Desai	Mechanical Engineering	TCS Ninja
224	Yash Borade	Mechanical Engineering	TCS Ninja

Faculty

List of Faculty

Automobile Engineering

Sr. No.	Title	Last Name	First Name	Post
1	Dr.	Padmanabhan	Divya	Professor
2	Mr.	Marathe	Amey	Associate Professor
3	Dr.	Talikoti	Basavaraj	Associate Professor
4	Mr.	Jafri	Salim	Assistant Professor
5	Mr.	Jain	Dipesh	Assistant Professor
6	Mrs.	Kadam	Komal	Assistant Professor
7	Ms.	Karmarkar	Geeta	Assistant Professor
8	Mr.	Khakare	Pankaj	Assistant Professor
9	Mr.	Menon	Krishnamohan	Assistant Professor
10	Mr.	Nijasure	Ameya	Assistant Professor
11	Mr.	Varghese	George	Assistant Professor

Computer Engineering

Sr. No.	Title	Last Name	First Name	Post
1	Dr.	Govilkar	Sharvari	Professor
2	Dr.	Nitnaware	Prashant	Professor
3	Dr.	Gawade	Sushopti	Professor
4	Mrs.	Bhojane	Varunakshi	Associate Professor
5	Mrs.	Nikhare	Rupali	Associate Professor
6	Ms.	Gaonkar	Ranjita	Assistant Professor
7	Mr.	K	Suresh Babu	Assistant Professor
8	Mr.	Kharat	Amol	Assistant Professor
9	Mrs.	Ks	Charumathi	Assistant Professor
10	Mr.	Kulkarni	Sagar	Associate Professor
11	Mrs.	Lawand	Deepti	Assistant Professor
12	Ms.	More	Smita	Assistant Professor
13	Ms.	Nair	Krishnendu	Assistant Professor
14	Ms.	Selvan	Sangeetha	Assistant Professor
15	Ms.	Cherian	Mimi	Assistant Professor

16	Mr.	Vyawahare	Madhura	Associate Professor
17	Ms.	Thakur	Payel	Assistant Professor
18	Mr.	Tilak	Sujit	Assistant Professor
19	Ms.	Varghese	Blessy	Assistant Professor
20	Ms.	Shelke	Sunil	Assistant Professor
21	Ms.	Patil	Bhagyashri	Assistant Professor
22	Ms.	Marulkar	Pallavi	Lecturer

Electronics and Telecommunication Engineering

Sr. No.	Title	Last Name	First Name	Post
1	Dr.	Vaidya	Avinash	Professor
2	Mrs.	Banerjee	Tusharika	Associate Professor
3	Mrs.	Bhosale	Jayshree	Associate Professor
4	Mr.	Shah	Pragnesh	Associate Professor
5	Ms.	Chiramel	Liril	Assistant Professor
6	Mr.	Gourkar	Swapnil	Assistant Professor
7	Mr.	Kene	Yogesh	Assistant Professor
8	Mrs.	Patil	Suchitra	Assistant Professor
9	Ms.	Sharma	Harsha	Assistant Professor
10	Ms.	Simon	Florence	Assistant Professor
11	Ms.	Singh	Manisha	Assistant Professor
12	Ms.	Waghmare	Sweta	Assistant Professor
13	Ms.	Khedkar	Aboli	Assistant Professor
14	Mr.	Riar	Ishmeet Singh	Assistant Professor
15	Mr.	Tiwari	Dinesh	Assistant Professor
16	Ms.	Patole	Ruchira	Assistant Professor
17	Mr.	Mehta	Ameet	Assistant Professor

Electronics & Computer Science

Sr. No.	Title	Last Name	First Name	Post
1	Dr.	Goyal	Premasagar	Professor
2	Dr.	Khade	Rajendrakumar	Professor
3	Dr.	Purnaiah	G Sita	Professor
4	Dr.	Bhagwat	Monika	Professor

5	Mr.	Biradar	Ravi	Associate Professor
6	Mr.	Harode	Ujwal	Associate Professor
7	Dr.	Srivastava	Sanjeevkumar	Associate Professor
8	Mrs.	Wadkar	Suman	Associate Professor
9	Mrs.	Bangde	Padmaja	Assistant Professor
10	Mrs.	Chavan	Apeksha	Assistant Professor
11	Mrs.	Chikodi	Sneha	Assistant Professor
12	Mrs.	Kathare	Sonali	Assistant Professor
13	Ms.	Kharat	Meera	Assistant Professor
14	Mrs.	Mishra	Seema	Assistant Professor
15	Mrs.	Nair	Deepti	Assistant Professor
16	Mrs.	Patil	Swati	Assistant Professor
17	Ms.	Pillai	Uma	Assistant Professor
18	Mr.	Saraf	Ajit	Assistant Professor
19	Miss	Shaikh	Rubina	Assistant Professor
20	Mr.	Vange	Anup	Assistant Professor
21	Dr.	Shishir	Jagtap	Associate Professor
22	Mr	Hariharan	B	Assistant Professor
23	Mr	Menon	Srikumar	Assistant Professor

Information Technology

Sr. No.	Title	Last Name	First Name	Post
1	Dr.	Varma	Satishkumar	Professor
2	Dr.	Lokhande	Prashant	Professor
3	Mr.	Bhise	Prakash	Associate Professor
4	Ms.	Hegade	Gayatri	Associate Professor
5	Dr.	Nashipudimath	Madhu	Associate Professor
6	Ms.	Amin	Dhiraj	Assistant Professor
7	Ms.	Chavan	Shubhangi	Assistant Professor
8	Mrs.	Gawande	Sheetal	Assistant Professor
9	Mrs.	Joshi	Smita	Assistant Professor
10	Mrs.	Kulkarni	Manasi	Assistant Professor
11	Mrs.	Lawand	Suhas	Assistant Professor
12	Ms.	P	Sowmya	Assistant Professor
13	Ms.	Palleri	Aju	Assistant Professor

14	Mr.	Patil	Shweta	Assistant Professor
15	Ms.	Y.I.	Jinesh Melvin	Assistant Professor
16	Ms.	Benny	Stephy	Assistant Professor
17	Ms.	Pranita	Pingale	Assistant Professor
18	Mr	Ninad	Gaikawad	Assistant Professor
19	Mr	Gaurav	Sharma	Assistant Professor
20	Ms.	Pritika	Chatta	Assistant Professor
21	Ms.	Gawand	Yogandhara	Assistant Professor
22	Ms.	Mhatre	Tejali	Assistant Professor
23	Ms.	Vijayabharati	Jagan	Assistant Professor

Mechanical Engineering

Sr. No.	Title	Last Name	First Name	Post
1	Dr.	Joshi	Sandeep	Professor
2	Dr.	Pillai	Priam	Professor
3	Dr.	Tambuskar	Dhanraj	Professor
4	Dr.	Agrawal	Richa	Associate Professor
5	Dr.	Ali	Rashed	Associate Professor
6	Mr.	Miriyala	Durga N.K.P. Rao	Associate Professor
7	Mr.	Rahane	Pruthaviraj	Associate Professor
8	Dr.	Sahasrabudhe	Onkar	Associate Professor
9	Mr.	Shaligram	Avinash	Associate Professor
10	Mr.	Thokal	Gajanan	Associate Professor
11	Mr.	Babu	Binsu	Assistant Professor
12	Mr.	Kelkar	Jagdish	Assistant Professor
13	Mrs.	Kumbhar	Vaishali	Assistant Professor
14	Mr.	M	Shiva Pradeep	Assistant Professor
15	Mr.	Mehta	Lalit	Assistant Professor
16	Miss	Mondkar	Shilpa	Assistant Professor
17	Mr.	More	Bhagvan	Assistant Professor
18	Mr.	Shaikh	Mohammed Shahid	Assistant Professor
19	Mr.	V	Sojan	Assistant Professor
20	Mrs.	Vedpathak	Meeta	Assistant Professor
21	Mr.	Verma	Tikaram	Assistant Professor

22	Mr.	Verma	Manikant	Assistant Professor
23	Mr.	Ravi Shanker	Rama Shanker	Assistant Professor
24	Dr	Bhosale	Digvijay	Assistant Professor
25	Mr.	Suryavanshi	Vinayak	Assistant Professor
26	Mrs.	Nikale	Surabhi	Assistant Professor
27	Mr.	Bhamare	Manoj	Assistant Professor

Applied Science, Mathematics and Humanities

Sr. No.	Title	Last Name	First Name	Post
1	Dr.	Pillai	Arun	Professor
2	Dr.	Pillai	Manju	Professor
3	Dr.	Saxena	Snigdha	Professor
4	Dr.	Murarka	Anshu	Associate Professor
5	Dr.	Panda	Biswajit	Associate Professor
6	Dr.	Khandkar	Mahendra	Associate Professor
7	Dr.	Sharma	Malvika	Associate Professor
8	Mr.	Nikam	Ravindra	Associate Professor
9	Dr.	Wani	Sachin	Associate Professor
10	Dr.	Deulakr	Sundeeep	Associate Professor
11	Dr.	Singh	Surabhi	Associate Professor
12	Mrs.	Ingole	Archana	Assistant Professor
13	Mrs.	Pachkawade	Darshana	Assistant Professor
14	Dr.	Shrivastava	Deepali	Associate Professor
15	Mrs.	Chaudhari	Kamini	Assistant Professor
16	Ms.	S	Kuberal	Assistant Professor
17	Mrs.	Potdar	Leena	Assistant Professor
18	Ms.	Pradhan	Lilly	Assistant Professor
19	Mr.	Kudre	Maheshkumar	Assistant Professor
20	Ms.	P	Neethu	Assistant Professor
21	Ms.	Nair	Rakhee	Assistant Professor
22	Mr.	Mhatre	Sangit	Assistant Professor
23	Ms.	Jondhale	Sneha	Assistant Professor
24	Mrs.	Nikam	Sonali	Assistant Professor
25	Ms.	Gaikwad	Suvarna	Assistant Professor
26	Mr	Raju	Arun	Assistant Professor

List of faculty with Ph.D qualification

Sr. No.	Name of Faculty	Department	PhD. Qualifying year
1	Dr. Premsagar Goyal	Electronics and Computer Science	1979
2	Dr. Snigdha Saxena	Applied Science, Mathematics and Humanities	1994
3	Dr. Malvika Sharma	Applied Science, Mathematics and Humanities	2000
4	Dr. Manju Pillai	Applied Science, Mathematics and Humanities	2001
5	Dr. Mahendra Khandkar	Applied Science, Mathematics and Humanities	2001
6	Dr. G Sita Purnaiah	Electronics and Computer Science	2002
7	Dr. Sundeep Deulakr	Applied Science, Mathematics and Humanities	2006
8	Dr. Arun Pillai	Applied Science, Mathematics and Humanities	2008
9	Dr. Anshu Murarka	Applied Science, Mathematics and Humanities	2010
10	Dr. Surabhi Singh	Applied Science, Mathematics and Humanities	2010
11	Dr. Deepali Shrivastava	Applied Science, Mathematics and Humanities	2010
12	Dr. Biswajit Panda	Applied Science, Mathematics and Humanities	2011
13	Dr. Priam Pillai	Mechanical Engineering	2011
14	Dr. Satishkumar Varma	Information Technology	2013
15	Dr. Sachin Wani	Applied Science, Mathematics and Humanities	2014
16	Dr. Avinash Vaidya	Electronics and Telecommunication Engineering	2015
17	Dr. Dhanraj Tambuskar	Mechanical Engineering	2015
18	Dr. Sharvari Govilkar	Computer Engineering	Feb-17
19	Dr. Sandeep Murlidhar Joshi	Mechanical Engineering	May-17

20	Dr. Divya Padmanabhan	Automobile Engineering	June - 17
21	Dr. Basavaraj Talikoti	Mechanical Engineering	Aug - 17
22	Dr. Rajendrakumar H Khade	Electronics and Computer Science	May-18
23	Dr. Prashant S. Lokhande	Computer Engineering	Feb-18
24	Dr. Sanjeev Kumar Srivastava	Electronics and Computer Science	Jul-18
25	Dr. Onkar Sahasrabudhe	Mechanical Engineering	Aug-18
26	Dr. Richa S Agrawal	Mechanical Engineering	Sep-18
27	Dr. Prashant Nitnaware	Computer Engineering	Apr-19
28	Dr. Sushopti Gawade	Computer Engineering	Aug-19
29	Dr. Rashed Ali	Mechanical Engineering	Jun-19
30	Dr. Jagtap Shishir	Electronics and Computer Science	Nov-19
31	Dr. Madhu M Nashipudimath	Computer Engineering	July-20
32	Dr. Gajanan N Thokal	Mechanical Engineering	July-20
33	Dr. Monika Bhagwat	Electronics and Computer Science	July-20
34	Dr. Kuberal S	Applied Science, Mathematics and Humanities	Sep - 20
35	Dr. Digvijay Bhosale	Mechanical Engineering	April-21
36	Dr. Suman P Wadkar	Electronics and Computer Science	April-21
37	Ravindra Nikam	Applied Science, Mathematics and Humanities	Pursuing
38	Leena Potdar	Applied Science, Mathematics and Humanities	
39	Kamini Chaudhary	Applied Science, Mathematics and Humanities	
40	Archana Ingole	Applied Science, Mathematics and Humanities	
41	Amey P Marathe	Automobile Engineering	
42	Avinash G Shaligram	Mechanical Engineering	
43	Pruthviraj P Rahane	Mechanical Engineering	

44	Geeta Karmarkar	Mechanical Engineering
45	Ameya Pradip Nijasure	Mechanical Engineering
46	Binsu Babu	Mechanical Engineering
47	Vinayak Suryawanshi	Mechanical Engineering
48	Sagar Kulkarni	Computer Engineering
49	Dhiraj Amin	Computer Engineering
50	Madhura Vyawahare	Computer Engineering
51	Prakash Dayanand Bhise	Computer Engineering
52	Mimi Miriam Cherian	Computer Engineering
53	Gayatri H Hegde	Computer Engineering
54	Ujwal Harode	Electronics and Computer Science
55	Tusharika Banerjee	Electronics and Computer Science
56	Ravi Biradar	Electronics and Computer Science
57	Ameet Mehta	Electronics and Computer Science
58	Yogesh V Kene	Electronics and Computer Science
59	Seema Mishra	Electronics and Computer Science
60	Pragnesh Shah	Electronics and Telecommunication Engineering
61	Suchitra Patil	Electronics and Telecommunication Engineering
62	Y. I. Jinesh Melvin	Information Technology

Research Publications by Faculty

Sr. No.	Branch	No of Publications
1	Automobile Engineering	2
2	Computer Engineering	59
3	Electronics and Telecommunication Engineering	2
4	Electronics and Computer Science	5
5	Information Technology	32
6	Mechanical Engineering	16
7	Applied Science, Mathematics and Humanities	12
	Total	128

Department of Automobile Engineering

Sn	Title of paper/Book	Name of the Author/s	Name of Journal/ Conference/Publisher
1.	Natural fibre reinforced composites with improved water permeability	Dr. Divya Padmanabhan	International conference on Advances in Mechanical Engineering
2.	Improving water permeability in ultrafiltration membranes by natural fibre reinforcents	Dr. Divya Padmanabhan	International Conference on Sustainable Technologies for Water Treatment and Desalination (STWTD - 2020)

Department of Computer Engineering

Sn	Title of paper/Book	Name of the Author/s	Name of Journal/ Conference/Publisher
1.	Survey on Multi-agent Driving Game Simulator	Payel Thakur	International Journal of Scientific Research in Engineering and Management (IJSREM)
2.	Implementation of Early Flood Monitoring System using IoT Applications	Payel Thakur	International Journal of Scientific Research in Engineering and Management(IJSREM)
3.	Driving Simulation Game based on Reinforcement Learning	Payel Thakur	International Journal for Research in Applied Science & Engineering Technology (IJRASET)
4.	Fake Review Monitoring and	Krishnendu	International Research Journal of Engineering

	Automated Chatbot	Nair	and Technology (IRJET)
5.	Bidirectional Communication Device for Deaf, Dumb and Blind	Krishnendu Nair	International Research Journal of Engineering and Technology (IRJET)
6.	Advance E-Tutor: 'E-Programming Hut' Based on E-	Krishnendu Nair	International Journal for Science and Advance Research In Technology(IJSART)
7.	Student Attendance With Fingerprint Reader	Blessy Vargese	International Research Journal of Engineering and Technology (IRJET)
8.	Weed Detection In Indian Fields And Disease Detection Using Convolutional Neural Network	K S Charumathi	International Research Journal of Engineering and Technology (IRJET)
9.	Improved Disability Assistant Android Mobile Application	K S Charumathi	International Research Journal of Engineering and Technology (IRJET)
10.	URL based Email Phishing Detection Application	K S Charumathi	International Research Journal of Engineering and Technology (IRJET)
11.	Adaptive smart signal to improve transportation situation in urban areas	Mimi Cherian	international journal for science and advance research in technology(IJSART)
12.	Survey on Driver Drowsiness Detection System	Mimi Cherian	International Journal of Scientific Research in Engineering and Management(IJSREM)
13.	IoT Based Home Security Management System	Mimi Cherian	International Journal of Scientific Research in Engineering and Management(IJSREM)
14.	Dynamic Traffic Monitoring System	Mimi Cherian	International Journal For Science And Advance Research In Technology(IJSART)
15.	Driver Drowsiness Detection System	Mimi Cherian	International Journal for Research in Applied Science & Engineering Technology (IJRASET)
16.	Medical Image Segmentation	Deepti Lawand	International Research Journal of Engineering and Technology (IRJET)
17.	Attendance management system using facial recognition	Deepti Lawand	International Journal For Science And Advance Research In Technology(IJSART)
18.	Vlearn Personalized E-learning Recommendation System	Deepti Lawand	International Journal of Scientific Research in Engineering and Management (IJSREM)
19.	Message Filtering System in Online Social Networks	Madhura Vyawahare	International Research Journal of Engineering and Technology (IRJET)
20.	Prediction of Employee Attrition	Sangeetha Selvan	International journal of Advances in Engineering and Management (IJAEM)
21.	Survey Paper on Prediction of	Sangeetha	Internation Journal of Scientific Research in

	Employee Attrition	Selvan	Engineering and Management(IJSREM)
22.	Survey Paper on Housing Society Management System	Sangeetha Selvan	International Research Journal of Engineering and Technology (IRJET)
23.	Survey of various techniques for Insincere Question Classification	Dr. Sharvari Govilkar	International Journal of Creative Research Thoughts
24.	Code Mixed SEntiment Analysis for Multilingual(HI-EN]Social media text	Dr. Sharvari Govilkar	International Journal of Creative Research Thoughts
25.	Open Domain Question Answering System Using Wikipedia	Dr. Sharvari Govilkar	International Journal of Innovative reserach in technology
26.	Web based College Placement Analysis	Dr. Sharvari Govilkar	International Research Journal of Engineering and Technology (IRJET)
27.	Prediction of Diabetes using Machine Learning	Sangeetha Selvan	International journal of Advances in Engineering and Management (IJAEM)
28.	Identification Of Textual Similarity From Image Contents Using Semantic Analysis	Sagar Kulkarni	International Research Journal of Modernization in Engineering Technology and Science
29.	Virtual Classroom System	Ranjita Chalke	International Research Journal of Engineering and Technology (IRJET)
30.	Smart Doctor Android Application for breast cancer risk prediction and diagnosis	Ranjita Chalke	International Journal of Creative Research Thoughts
31.	Health Monitoring IoT + Android Application for Pregnant Women	Ranjita Chalke	International Research Journal of Engineering and Technology (IRJET)
32.	A Proposed Approach For Voice assistance In Educational Institution	Smita Kadam	International Journal of Creative Research Thoughts (IJCRT)
33.	A proposed approach for personalized health assistance	Smita Kadam	International Journal of Scientific Research in Engineering and Management (IJSREM)
34.	Web Based Voice Assistant for Educational System	Smita Kadam	International journal of Advances in Engineering and Management (IJAEM)
35.	Personalized Health Assistance Application My Health Mate	Smita Kadam	IJRAR - International Journal of Research and Analytical Reviews (IJRAR)
36.	IOT applications and its social cause	Sushopti Gawade	Internation Journal of Scientific Research in Engineering and Management (IJSREM)
37.	Student Learning Time Analysis during COVID-19 with Online and Offline mode	Sushopti Gawade	Journal-Paper (IJSRCSE)

38.	Prediction of heart disease and diabetes using Naive Bayes Algorithm	Sushopti Gawade	International Journal of Scientific Research in Computer science, Engineering and Information Technology(IJSRCSEIT)
39.	E-MandiFarm	Sushopti Gawade	International Journal of Current Microbiology and Applied Sciences(IJCMAS)
40.	Emotion Recognition from Facial Expression using Deep Learning	Sujit Tilak	International Research Journal of Engineering and Technology (IRJET)
41.	Smart tracking App to prevent COVID 19 using AIOT.	Payel Thakur	6th National conference on advancement in Information technology organized by department of Information science and engineering, JSSATE, Bengaluru (NCAIT-2020)
42.	Smart tracking App to prevent COVID 19 using AIOT.	Krishnendu Nair	6th National conference on advancement in Information technology organized by department of Information science and engineering, JSSATE, Bengaluru (NCAIT-2020)
43.	Example based chat oriented dialogue system with personalized long term memory	Krishnendu Nair	AICTE Funded International Conference on Recent Trends in Computers, Electronics and Electrical Engineering,(ICCEEE2020) Organized by St. Peter's Engineering College, Hyderabad, from 24" to 26" August, 2020.
44.	Integration of SDN and IoT to mitigate Network attack	Mimi Cherian	3rd International Conference on Computer Network, Big Data and IoT, Springer , 2020
45.	An Empirical Study Of Deep Learning Models For Abstractive Text Summarization	Dr. Sharvari Govilkar	CISC 2021 : 5th International Conference on Inventive Systems and Control Proceedings indexed by : Springer, Pichanur, India
46.	Analysis of Plagiarism Detection Tools and Methods	Dr. Sharvari Govilkar	4th International Conference on Advances in Science and Technology (ICAST-2021) oragnized by KJSEIT in association with IET , India and University of Mumbai
47.	An Efficient Sentiment Analysis on Feedback Assessment from Student to Provide Better Education	K.S.Suresh Babu	2020 Fourth International Conference on I-SMAC (IoT in Social, Mobile, Analytics and Cloud) (I-SMAC)
48.	Analysis of Plagiarism Detection Tools and Methods	Sagar Kulkarni	4th International conference on advances in science and technology ICAST 2021, by K.J Somaiya Institute of Technology Sion.
49.	NA	Sushopti	Book Chapter in Book: Demystifying IOT

		Gawade	challenges and Applications in Apple Academic Press (AAP), CRC press, Taylor and Fansis Group , USA
50.	Usability improvements in e-Governance applications with simple and usable interface	Sushopti Gawade	International Conference on Advance Informatics for Computing Research ICAICR 2020 (Publication Partner Springer,Proceedings indexed by : Springer)
51.	Usability Analysis of e-Governance Application	Sushopti Gawade	International Conference on Advance Informatics for Computing Research ICAICR 2020 (Publication Partner Springer,Proceedings indexed by : Springer)
52.	MoraleBoost : Motivational tool for emotion analysis and support during COVID 19	Sushopti Gawade	Young Scientist Conference , India International Science Festival 2020 (IISF2020), presented paper on 22-12-20 to 25-12-20, organised by Misnistry of Science and Technology; Ministry of Earth sciences and Ministry of Health and Family Welfare ,Govt. of India in collaboration with Vijanana Bharati (VIBHA) by Council of Scientific and Industrial research (CSIR)
53.	Effectiveness of Robotic Process Automation for data mining using UiPath	Sushopti Gawade	2021 International Conference on Artificial Intelligence and Smart Systems (ICAIS) Year: 2021 Conference Paper Publisher: IEEE
54.	Visual Question Answering using Data Mining Techniques for Skeletal Scintigraphy in medical domain - VQADMSS	Sushopti Gawade	2021 International Conference on Artificial Intelligence and Smart Systems (ICAIS) Year: 2021 Conference Paper Publisher: IEEE
55.	A machine learning approach for prediction system and analysis of nutrients uptake for better crop growth in the Hydroponics system	Sushopti Gawade	2021 International Conference on Artificial Intelligence and Smart Systems (ICAIS) Year: 2021 Conference Paper Publisher: IEEE
56.	A Proposed Prediction System and Analysis of Nutrients Uptake For Better Crop Growth in Hydroponics System.	Sushopti Gawade	First International Conference on AGRONOMY (IECAG21)
57.	Feature Extraction from Radiology images for Visual question answering system using CNN and BiLSTM Model	Sushopti Gawade	ICRIC 21 , Jammu

58.	Student Learning Analysis with Impact of Self Learning and Effectiveness during COVID	Sushopti Gawade	ICRIC 21 , Jammu
59.	Usability Improvements in E-Governance Application with Simple & Usable Interface using Citizen-Satisfaction-Model-of-Performance-Related-Pay (CSMPRP)	Sushopti Gawade	ICRIC 21 , Jammu

Department of Electronics and Telecommunication Engineering

Sn	Title of paper/Book	Name of the Author/s	Name of Journal/ Conference/Publisher
1.	Sheet Beam Driven Metamaterial Backward Wave Oscillator	Tusharika S. Banerjee	International Conference on Plasma Sciences-2020
2.	Performance Analysis of Image Coding methods using Wavelet and Noise Shaping	Suchitra A. Patil	2020 Fourth International Conference on Inventive Systems and Control (ICISC)

Department of Electronics and Computer Science

Sn	Title of paper/Book	Name of the Author/s	Name of Journal/ Conference/Publisher
1.	A Compact MIMO antenna, using Amalgamation of Diversity Techniques and Concept of Dual Polarization	Shishir Jagtap	International conference on Antenna Test Measurements Society, on 20th of Feb. 2021.
2.	Implementation of RFID Systems for Various Applications and Its Performance Parameters	Shishir Jagtap	International conference on Antenna Test Measurements Society, on 20th of Feb. 2021.
3.	Disturbance Rejection and Harmonic mitigation for Solid State Transformer through Passivity Based Control	Monika Bhagwat	IEEE 30th International Symposium on Industrial Electronics (ISIE)
4.	Gain Flattening of Wideband FPC Antenna Using Elliptical and Rectangular Slotted AMC Layers	Shishir Jagtap	Progress In Electromagnetics Research C
5.	Gain Bandwidth enhancement of a microstrip antenna fed half wavelength 4 Fabry Perot Cavity Antenna	Shishir Jagtap	International Journal of RF and Microwave Computer-Aided Engineering (RFCAD)

Department of Information Tecnology

Sn	Title of paper/Book	Name of the Author/s	Name of Journal/ Conference/Publisher
1.	Predicting Employees Performance using Data Mining Techniques	Dr. Madhu N	ICAICT -21 organised by sarawati college of engineering college, Kharghar
2.	Sentimental Analysis using Hybrid Feature Extraction for Hotel Reviews	Dr. Madhu N	ICAICT -21 organised by sarawati college of engineering college, Kharghar
3.	Transcript Generation for American Sign language Gestures using Convolutional Neural Network	Shubhangi Chavan	4th International conference on advances in science and technology ICAST 2021 organised by K.J Somaiya Institute of Technology Sion.
4.	Detection of Fake and Clone accounts in Twitter using Classification and Distance Measure Algorithms	Sowmya P	9th IEEE International Conference on Communication and Signal Processing (ICCSP)
5.	"Survey on Classification Algorithm in Machine Learning"	Dr. Satishkumar Verma	52nd Mid Term Symposium (MTS) on the theme 'Emerging Trends in ICT and Electronics' organized by IETE in the virtual mode on April 30, 2021.
6.	Comparative Analysis of Neural Network and Machine Learning Techniques for Air Quality Prediction	Dr. Satishkumar Verma	2nd International Conference on Advances in Computing, Communication Control and Networking (ICACCCN), Greater Noida, India, 2020, pp. 724-729, Dec 2020.
7.	Computer Vision Based Campus Surveillance	Dr. Satishkumar Verma	International Conference on Advances in Computing, Communication Control and Networking (ICACCCN), Greater Noida, India, pp. 1013-1018, Dec 2020.
8.	TV Show Popularity Analysis	Gayatri Hegde	International Journal of Creative Research Thoughts-IJCRT
9.	Face Recognition Based Door Unlocking Using Raspberry PI	Gayatri Hegde	International Journal of Innovative Research in Technology, IJIRT
10.	Voice Assistant Android Application	Gayatri Hegde	International Journal of Creative Research Thoughts-IJCRT
11.	Soil Fertigation System for Desired Crop Using IoT and Machine Learning	Gayatri Hegde	International Journal of Scientific Research in Engineering and Management (IJSREM)
12.	An efficient integration and indexing method based on feature patterns and	Dr. Madhu N	Elsevier(ARRAY)

	semantic analysis for big data		
13.	Extractive Based Approach For Microblogs Summarization	Shubhangi Chavan	International Research Journal of Modernization in Engineering Technology and Science
14.	Remote Patient Monitoring System	Shubhangi Chavan	International Research Journal of Engineering and Technology (IRJET)
15.	The Education Trust Recommendation System	Prof.Suhas Lawand	International Journal of Scientific Research in Engineering and Management (IJSREM)
16.	Student Grievance Support System	Prof.Suhas Lawand	International Journal For Science And Advance Research In Technology (IJSART)
17.	Deepfake Video Detection using Neural Networks	Prof.Suhas Lawand	International Journal of Innovative Research in Technology, IJIRT
18.	Cyber Bully Indicator	Shweta Patil	International Journal For Science And Advance Research In Technology(IJSART)
19.	Emulating real world Strategic Intelligence using Artificial Intelligence in gaming	Shweta Patil	International Journal For Science And Advance Research In Technology(IJSART)
20.	Social media caption generator using deep learning approach	Shweta Patil	International Journal For Science And Advance Research In Technology(IJSART)
21.	Emulating real world strategic intelligence using artificial intelligence in gaming	Shweta Patil	International Journal For Science And Advance Research In Technology(IJSART)
22.	Detection Of Cyberbully Sentiments In Social Media Channels	Shweta Patil	International Journal For Science And Advance Research In Technology(IJSART)
23.	Extraction of Legal Documents for Assistance to Lawyers	Manasi Kulkarni	International Research Journal of Engineering and Technology (IRJET)
24.	Fruit Classification and Calories Measurement using Machine Learning and Deep Learning	Dr. Satishkumar Verma	International Research Journal of Engineering and Technology (IRJET)
25.	Sentiment Analysis of Product Reviews	Dr. Satishkumar Verma	International Journal of Advanced Science and Technology
26.	Survey on Text Classification	Dr. Satishkumar Verma	International Journal of Innovative Science and Research Technology
27.	Smart Alarm Clock with Home Automation:A Novel Approach	Sheetal Gawande	International Journal of Scientific Research in Engineering and Management (IJSREM)

28.	Anti Theft and Accident Avoidance System for Low Visibility Environment	Sheetal Gawande	International Journal of Scientific Research in Engineering and Management (IJSREM)
29.	Smart Mirror In Automobile Sector for Business Perspective	Jinesh Melvin Y I	International Research Journal of Engineering and Technology (IRJET)
30.	Online Email Phishing Detection using Machine Learning Classifiers	Jinesh Melvin Y I	International Journal of Scientific Research in Engineering and Management
31.	ASK IMAGE: A Chatbot which Answers Questions on Image Captions	Dhiraj Amin	International Research Journal of Engineering and Technology (IRJET)
32.	Identification of mental health related issues from social media using natural language processing	Dhiraj Amin	International research journal of engineering and technology- IRJET

Department of Mechanical Engineering

Sn	Title of paper/Book	Name of the Author/s	Name of Journal/ Conference/Publisher
1.	Advances in Mechanical Engineering	Dr. Richa Agrawal	International Conference on Advances in Mechanical Engineering, ICAME-20
2.	Development of Underwater Monitoring System	Onkar S Sahasrabudhe	In press (ISBN 978-620-3-06620-3)
3.	Crop Monitoring using Image Processing	Onkar S Sahasrabudhe	ISBN 978-620-3-07930-2 IN PRESS
4.	Multi-Objective Optimization model for turning of Duplex stainless Steel (DSS) using Artificial Neural Network (ANN)	Dhanraj P Tambuskar	Indian Institution of Industrial Engineering, 62nd National Convention
5.	Fabrication and Characterization Biomimetic Micro Actuators Using Ferrofluid-Silicone Composite Cantilevers	Priam V. Pillai	Nano Hybrids and Composites Vol. 30
6.	Finite element analysis of synthetic and natural polymer blends made by 3D printing	Gajanan N. Thokal	Int. J. Nano and Biomaterials
7.	A review on Heat transfer & Flow Characteristics in Spiral tubes	Rashed Ali	IOSR Journal of Mechanical and Civil Engineering (IOSR-JMCE) Volume 17, Issue 6 Ser. IV (Nov. – Dec. 2020), PP 31-36

8.	High temperature erosion behaviour of SS 316L, APS and HVOF sprayed WC-Cr3C2-Ni coatings	Digvijay G. Bhosale	Wear 462, Elsevier
9.	Sliding and erosion wear behaviour of thermal sprayed WC-Cr3C2-Ni coatings	Digvijay G. Bhosale	Surface and Coatings Technology 400, Elsevier
10.	Nickel alloy C-263 protection by WC-Cr3C2-Ni coatings against high-temperature wear in nuclear applications	Digvijay G. Bhosale	Surfaces and Interfaces 21, Elsevier
11.	A study of T11 boiler steel protection by cold sprayed Inconel 738 coating against high temperature erosion	Digvijay G. Bhosale	Surfaces and Interfaces 23, Elsevier
12.	Effect of counter faces on sliding wear behavior of WC-Cr3C2-Ni composite coating deposited by high velocity oxy fuel	Digvijay G. Bhosale	Materials Today: Proceedings, Elsevier
13.	Dry Sliding Wear Behavior of HVOF Sprayed NiCrSiBFe Coating on SS 316L	Digvijay G. Bhosale	Materials Today: Proceedings, Elsevier
14.	Sliding wear investigation of Ni-based coating for high-temperature application	Digvijay G. Bhosale	Tribology in Industry
15.	High-temperature tribological investigation of APS and HVOF sprayed NiCrBSiFe coatings on SS 316L	Digvijay G. Bhosale	Tribology-Materials, Surfaces & Interfaces, Taylor and Francis
16.	Development of Noise Cancellation Device	Richa Agrawal	Int. Research Journal of Engineering and Technology

Department of Applied Science, Mathematics and Humanities

Sn	Title of paper/Book	Name of the Author/s	Name of Journal/Conference/Publisher
1.	Carbon Nanofibers- Fundamentals and Applications	Dr. Sundeep D	Wiley
2.	Engineering Mathematics-III	Dr. Sachin Wani	TechKnowledge Publications
3.	Synthesis of Polymer films with low	Dr Deepali	IOP-Journal of Physics: Conference

	Dielectric Constant (k)	Shrivastava	Series
4.	Effect of convection boundary condition on hyperbolic heat conduction in thermoelastic media	Kamini K Chaudhari	Journal of Mathematical and Computational Science
5.	Reduced differential transform method for thermoelastic problem in hyperbolic heat conduction domain	Kamini K Chaudhari	International journal of Applied Mechanics and Engineering
6.	Synthesis and Characterization of Biodiesel Prepared by Used and Unused Sunflower Oil through Transesterification Process	Dr Deepali Shrivastava	3rd International Oil & Gas Chemistry, Chemicals and Additives Conference (IOGCA 2020)
7.	Synthesis and Characterization of Biodiesel Prepared by Used and Unused Sunflower Oil through Transesterification Process	Dr Biswajit Panda	3rd International Oil & Gas Chemistry, Chemicals and Additives Conference (IOGCA 2020)
8.	Synthesis and Characterization of Biodiesel Prepared by Used and Unused Sunflower Oil through Transesterification Process	Dr Manju Pillai	3rd International Oil & Gas Chemistry, Chemicals and Additives Conference (IOGCA 2020)
9.	Synthesis and Characterization of Biodiesel Prepared by Used and Unused Sunflower Oil through Transesterification Process	Dr Surabhi	3rd International Oil & Gas Chemistry, Chemicals and Additives Conference (IOGCA 2020)
10.	Synthesis and Characterization of Biodiesel Prepared by Used and Unused Sunflower Oil through Transesterification Process	Sangit Mahatre	3rd International Oil & Gas Chemistry, Chemicals and Additives Conference (IOGCA 2020)
11.	Synthesis and Characterization of Biodiesel Prepared by Used and Unused Sunflower Oil through Transesterification Process	Sonali Mulick	3rd International Oil & Gas Chemistry, Chemicals and Additives Conference (IOGCA 2020)
12.	Magnetism and DFT calculations for understanding magnetic ground state of Fe doped Mn ₂ O ₃	Ravindra Nikam	Journal of Alloys and Compounds

Guest Lectures/ Seminars/Workshops/Webinars/FDPs organised by Departments

Department of Automobile and Mechanical Engineering

SN	Name of Activity	Date	Organiser	Speakers
1	Webinar on Pathway to Higher Studies Abroad	1 st July	PCE Alumni Association. Prof. Krishna Mohan	Mr. Aniket Jadhav, Mr. Deepak Padmanabhan, Mr. Suraj Panicker
2	Talk on "Opportunities for Automobile Engineers in Insurance Sector"	11 th July	Automobile Engineering Dept.	Mr. S.Waghmare
3	Talk on "Engineers beyond Core Industry - Avenues in BSFI Sector"	18 th July	Mechanical & Automobile Engineering Dept.	Mr. Utkarsh Shah, Senior Manager, Energy Underwriter Bharati Axa General Insurance
4	Talk on "Sales & Marketing as Career option for Engineers"	25 th July	Prof. Geeta Karmarkar	Mr. Abhijit Ambedkar, DGM - Business Development Jacobs
5	Certification webinar on "Scope of Automotive Industry during and after COVID-19"	28 th July	Prof. Shahid Shaikh, Prof. Krishnamohan Menon	Mr. Sundar Iyer
6	Two Days "ANSYS Workshop"	1 st – 2 nd August	Dr. Richa Agrawal , Prof. Binsu Babu	Dr. Richa Agrawal , Prof. Binsu Babu
7	Webinar on "Non Destructive Certifications"	1 st August	Mechanical & Automobile Engineering Dept.	Mr. Arvind Bhide, Metallurgical Consultant Steel making , Rolling & Heat treatment Application
8	Talk on "Leadership and Personality Development"	6 th August	Dr. Dhanraj Tambuskar, Prof. Jagdish Kelkar	AVM Suryakant Chafekar,
9	Webinar on "An introduction to Autodesk Revit & its uses in HVAC"	7 th August	ISHRAE Student chapter, Prof. Prithviraj Rahane	Mr. Abdul Majeed , Lead Engineer, Delta MEP, Technical Academy, Bangalore.
10	Webinar on "Scope of Data Science"	8 th August	Prof. Shivapradeep	Mr. Pradeep Kumar
11	R Programming Workshop	13 th – 20 th	Prof. Shivapradeep ,	Prof. Shivapradeep and

		August	Prof. Florence	Prof. Florence, Spoken Tutorials
12	Industry Institute Interaction on "Focus of Application Engineering for Mechanical Engineers"	29 th August	Department	G. S. R. Sarma, COO, Ardee Engineering Pvt. Ltd., Hyderabad
13	Value Added Course on "ANSYS"	29 th August – 24 th November	Dr. Richa Agrawal, Prof. Binsu Babu	Dr. Richa Agrawal, Prof. Binsu Babu
14	Value Added Course on "Industry 4.0"	29 th August – 27 th September	Prof. Salim Jafri	Prof. Salim Jafri
15	Industry Institute Interaction on "Corporate Entry - Attitude Matters"	5 th September	Department	Mr. Mangesh Bhalerao, General Manager (QA System Division) Burckhardt Compression (India) Pvt. Ltd.
16	Value Added Course on "Electric Vehicle"	16 th – 28 th September	Prof. Amey Marathe	Prof. Amey Marathe
17	Webinar on "Role of PLM in Industry"	12 th September	Dr. Richa Agrawal	Mr. Suhas Chaudhari, Associate Consultant at Tata Consultancy Services
18	Workshop on "Python"	16 th – 25 th September	Dr. Richa Agrawal , Prof. Suchitra Patil	Dr. Richa Agrawal , Prof. Suchitra Patil, Spoken Tutorial
19	Workshop on "QCAD"	5 th – 10 th October	Prof. Binsu Babu, Prof. Amey Nijasure	Prof. Binsu Babu, Prof. Amey Nijasure
20	Five day online Faculty Development Program on "Emerging Materials and Nanotechnology"	5 th – 9 th October	Dr. Divya Padmanabhan, Dr. Richa Agrawal	Schedule
21	Course on Certified Solidworks Associate (CSWA) and Certified Solidworks Professional (CSWP)	1 st – 30 th September	Prof. Binsu B. Prof. Ameya N	Mr. Tushar (Addonix Technologies Pvt Ltd.) Prof. Binsu Babu & Prof. Ameya Nijasure
22	Importance of CSWP Certifications	18 th September	Prof. Binsu B. Prof. Ameya N	Mr. Shaikh Abdullah
23	Webinar on "Owards Enabling Shape Memory Ceramics:	26 th November	Dr. Divya Padmanabhan	Dr. Viraj S Raut Founder CEO Azendiv

	Considerations for Stress Concentration Optimisation through Additive Manufacturing"			Technology OPC Pvt. Ltd.
24	3 Days Workshop on "Report Writing"	4 th – 6 th December	Dr. Richa Agrawal Prof. Amey Nijasure	Dr. Richa Agrawal & Prof. Amey Nijasure
25	Online Workshop on “Geometric Dimensions & Tolerance”	30 th January – 7 th February	Prof. Binsu Babu Prof. Amey Nijasure	Mr. Gulrez Khan, Prof. Binsu Babu Prof. Amey Nijasure
26	Faculty Orientation Program on "Python Programming"	10 th February	Dr. Dhanraj Tambuskar	Dr. Priam Pillai
27	Faculty Orientation Program on "CNC & 3D Printing"	11 th February	Dr. Richa Agrawal	Dr.R. Balasubramaniam, Dr. Nilesh Ghongade
28	ATAL Sponsored Faculty Development Programme on Product Design and Additive Manufacturing	15 th – 19 th February	Dr. Dhanraj Tambuskar	Schedule
29	Value Added course on ANSYS	17 th February	Dr. Richa Agrawal Prof. Binsu Babu Prof. Amey Nijasure	Dr. Richa Agrawal , Prof. Binsu Babu Prof. Amey Nijasure
30	Career opportunities in NDT and General Guidance	17 th February	Dr. Divya Padmanabhan	Ms. Anagha Bhide
31	Industry Expert Talk on "Exploring Opportunities in Non Destructive Testing"	27 th February	Dr. Divya Padamanabhan	Ms Anagha Bhide
32	Industry Expert Talk on "Opportunities Landscape for IT supported Manufacturing"	20 th February	Department	Mr. Sameer Wagh & Mrs. Savita Govilkar
33	Workshop on QCAD	20 th February	Prof. Binsu Babu Prof. Amey Nijasure	Prof. Binsu Babu Prof. Amey Nijasure
34	Faculty Development Program on "Modern Manufacturing echniques"	4 th – 6 th March	Dr. Richa Agrawal	Prof. Amol Shinde, Dr. Richa Agrawal , Prof. Amey Nijasure
35	Webinar on “Job Opportunities in Plant Design and Engineering”	19 th March	Dr. Dhanraj Tambuskar	Mr. Dayanand Wasate
36	Report Writing Workshop	27 th - 28 th March	Dr. Richa Agrawal Prof. Amey Nijasure	Dr. Richa Agrawal , Prof. Amey Nijasure
37	Industry Expert Talk on "Career in Operations and Supply Chain Management"	3 rd April	Dr. Divya Padmanabhan	Mr. Saurabh Lad

38	Gate 2022 Orientation	4 th April – 7 th July	Dr. Digvijay G. Bhosale	Dr. Digvijay G. Bhosale, Dr. Sachin S. Wani, Prof. Kamini K. Chaudhari, Prof. Suvarna H. Gaikwad
39	Industry Expert Talk on "Introduction to The World of Piping Design and Engineering"	10 th April	Dr. Dhanraj Tambuskar	Mr. TN Gopinath
40	BE Project Competition	16 th – 17 th April	Dr. Gajanan Thokal Prof. Krishnamohan Menon, Prof. Manoj Bhamre	NA
41	Industry Expert Talk on "Additive Manufacturing Digital Transformation & Robotics Automation"	24 th April	Dr. Richa Agrawal	Mr. Milind Deshpande & Mr. Hrishikesh Kolapkar
42	2 Days Online FDP on "Online Content Development"	1 st – 2 nd May	Prof. Amey Nijasure Prof. Krishnamohan Menon	Prof. Amey Nijasure & Prof. Krishnamohan Menon
43	Python Workshop	22 nd – 27 th March	Prof. Aboli Khedkar, Prof. Shiva Pradeep M., Prof. Sangeetha Sleevan	Prof. Aboli Khedkar, Prof. Shiva Pradeep M., Spoken Tutorial

Webinar on Pathway to Higher Studies Abroad

A webinar on “Pathway to Higher Studies Abroad” was organised on 1st July, 2020. The speakers for the session were PCE Alumni, Mr. Deepak Padmanabhan, Passout batch- 2013-14 (Mechanical Engineer), Mr. Suraj Panicker, Passout batch- 2013-14 (Mechanical Engineer) and Aniket Jadhav, Passout batch- 2013-14 (Automobile Engineer). They all were pursuing Doctorate courses abroad. The speakers shared their thought of overseas education by their experiences. It covered following topics: ME Vs MS, Exam requirements and preparation, Selecting Universities, Visa Process, Scholarships, fellowships, funding options, Cultural difference in approach to education, Finance during MS and What after MS?. About 175 students and 21 faculties attended the session.



Mahatma Education Society's
Pillai HOC College of Engineering and Technology, Rasayani
NAAC Accredited A
and
Pillai College of Engineering, New Panvel
NAAC Accredited A+
along with
PCE Alumni Association
Presents
WEBINAR on
PATHWAY TO HIGHER STUDIES ABROAD

By PCE Alumni
for
**Students of Automobile & Mechanical
Engineering of PCE & PHCET**

 July 1, 2020 at 10 AM

Register on or before: 29th June, 2020, 10.00PM
Register by MES-ID only
Participation E-Certificates to all the participants

Aniket Jadhav

- PHD candidate in Mechanical Sciences & Engineering, University of Michigan – Dearborn.
- MSE in Automotive Systems Engineering, University of Michigan - Dearborn.

Deepak Padmanabhan

- PHD candidate in Mechanical Engineering, Drexel University, Philadelphia.
- Engineering lead at Kinoss Medical Inc.
- MS in Mechanical Engineering from Drexel university, Philadelphia.

Suraj Panicker

- Doctoral researcher at Tampere University, Finland.
- MS in Industrial Engineering from Oregon State university.

Coordinators:
KS Anish 8898177950
Krishnamohan S Menon 7718057306



Talk on "Opportunities for Automobile Engineers in Insurance Sector"

AN INDUSTRY ACADEMIA INITIATIVE

PCE
PILLAI COLLEGE OF
ENGINEERING

ACCREDITED WITH GRADE
A+
NAAC

**OPPORTUNITIES FOR AUTOMOBILE
ENGINEERS IN INSURANCE SECTOR**

Speaker

Siddharth P. Waghmare
M.Tech, B.E, Automobile Engg, FIII
Assistant Manager
National Insurance Company Limited

11th July 2020
4:00-5:00 PM

A Event Organised by Department of Automobile Engineering



Talk on "Engineers beyond Core Industry - Avenues in BSFI Sector"

AN INDUSTRY ACADEMIA INITIATIVE

PCE
PILLAI COLLEGE OF
ENGINEERING

50
ANNIVERSARY

A+
NAAC

**Engineers beyond Core Industry –
Avenues in BSFI sector**

Google meet link : <https://meet.google.com/szp-bkvf-gri>

SPEAKER

Mr. Utkarsh Shah

Senior Manager, Energy Underwriter
Bharti Axa General Insurance

18th July, 2020
3:30 PM – 5.00 PM

An Event Organized by Department of Automobile & Mechanical Engineering

Talk on "Sales & Marketing as Career option for Engineers"

**MAHATMA EDUCATION SOCIETY'S
PILLAI COLLEGE OF ENGINEERING, NEW PANVEL**

PCE
PILLAI COLLEGE OF
ENGINEERING

50
ANNIVERSARY

A+
NAAC

AN INDUSTRY ACADEMIA INITIATIVE

**INTERACTIVE SESSION ON
SALES & MARKETING AS A CAREER OPTION FOR
ENGINEERS**

Speaker
Mr. Abhijit Ambekar
DGM - Business Development
Jacobs

Google meet link: meet.google.com/jcw-ggpc-qbw

25th July, 2020
3:00 PM – 5.00 PM

A Event Organized by Department of Automobile & Mechanical Engineering

A talk on “Sales & Marketing as a Career Option for Engineers” was organized on 25th July, 2020 for final year automobile and Mechanical students. The expert for the session was Mr. Abhijit Ambekar, DGM-Business development at JACOBS. The purpose behind the talk was: To give insights to technical Sales and Marketing functions, To make students aware about the importance of above fields from career point of view. To give an idea about various fields of Sales and Marketing, To clear the difference between Sales and Marketing fields.

Certification webinar on "Scope of Automotive Industry during and after COVID-19"





FREE CERTIFICATION WEBINAR ON
Scope in Automotive Industry





**PILLAI COLLEGE OF ENGINEERING, NEW PANVEL, DEPARTMENT OF
 AUTOMOBILE AND MECHANICAL ENGINEERING WITH
 ELITE TECHNO GROUPS**

**Topics
Covered**



Sundar Iyer
 7 yr + Exp in Honda, Volvo
 Research & Development
 ME, Rochester IT, USA

- Current Trends & Technologies in Vehicle Dynamics & Design
- Engineering Positions in Core Industries
- Expectations of Industry from a Fresher
- How could you be Industry Ready to meet the requirement?

Takeaways from the Webinar

- Certificate to all Participants
- Understanding of how industry works
- Knowledge which you can implement

Coordinators:
 Dr. Dhanraj Tambuskar (H.O.D. - ME Dept.)
 Dr. Divya Padmanabhan (H.O.D.- Automobile Engg. Dept.)
 Dr. Sandeep Joshi (Principal)
 Prof. Shaikh Mohammed Shahid Irfanulhaque (Asst. Prof.)
 Prof. Krishnamohan Menon (Asst. Prof.)

REGISTER NOW



JULY
28



4:30
AM

A webinar on “Scope of Automotive Industry during and after COVID-19” was organized on 28th July, 2020 to make the participants aware of the situation post COVID pandemic. The speaker for the session was an Industry expert Mr Sundar Iyer from Elite Techno Group who had 7+ years of experience in R&D of Honda, Volvo CE, USA. The aim of the webinar was to give attendees an exposure to Current Trends & Technologies in Automotive Dynamics & Design, Engineering Positions in Core Industries, Expectations of Industry from a Fresher and How could you be Industry Ready to meet the requirement?

Two Days Workshop on ANSYS

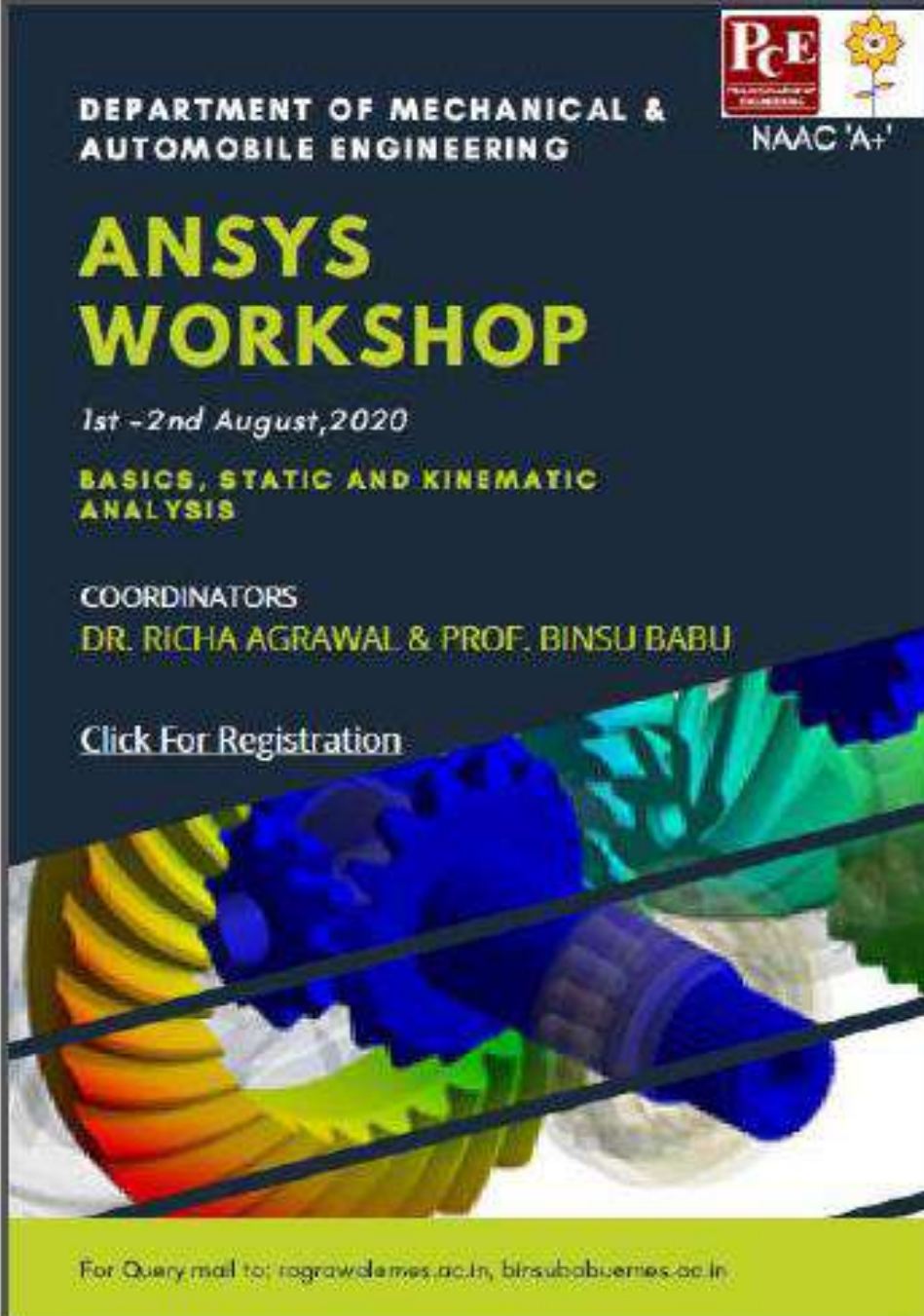

DEPARTMENT OF MECHANICAL & AUTOMOBILE ENGINEERING

ANSYS WORKSHOP

1st -2nd August, 2020

BASICS, STATIC AND KINEMATIC ANALYSIS

COORDINATORS
DR. RICHA AGRAWAL & PROF. BINSU BABU

[Click For Registration](#)

For Query mail to: ragrawal@mes.ac.in, binsubabu@mes.ac.in

NAAC 'A+'

A two days ANSYS Workshop was organized on 1st and 2nd August, 2020. Around 150 students and faculty members registered for the workshop. The workshop content was designed to impart a basic understanding of the theoretical concept required to utilize the FEA package in a more efficient way. Hands on sessions on few structural analyses using ANSYS Software was included in the practical sessions. The content covered was also shared with the participants through youtube channel.

Webinar on "Non Destructive Certifications"



AN INDUSTRY ACADEMIA INITIATIVE

Non-Destructive Testing Certifications

Join the webinar by clicking  Or Go to Google Meet and enter cac-ttza-fxi

Mr. Arvind Bhide,
Metallurgical Consultant
Steel making , Rolling &
Heat treatment Application

 **1st August, 2020**
4:00 PM – 5:00 PM

A Event Organized by Department of Automobile & Mechanical Engineering

Talk on "Leadership and Personality Development"

A talk on “Leadership and Personality Development” was organized on 6th August, 2020 at 4.00 pm on an online mode. The institute was honored to have **AVM (Air Vice Marshal) Suryakant Chafekar (Retd)** as the speaker for the session. He is a public speaker and also a motivator. AVM Suryakant Chafekar Sir is an alumnus of Defence Service Staff College, Wellington. He is a qualified Flying instructor with over 3500 instructional hrs to his credit. He has flown more than 7000 hrs on various types of aircraft. Sir was awarded **Shaurya Chakra a gallantry award** by President of India and also was awarded with the **Ati Vishisht Seva Medal** for Distinguished Devotion to Duty. He contributed immensely in Kargil Operations. The talk enabled the participants to explore their personal qualities and develop their capacity to become a leader in every aspect of their life. He shared his experience of planning and executing the

Antonov An-32 landing at Daulat Beg Oldi during tenure of Commanding Officer of No. 48 Squadron IAF. He also discussed about the various attributes of leadership i.e. Wisdom, Credibility, Benelovance, Courage and discipline. The session ended with queries from the participants which were addressed by the speaker.

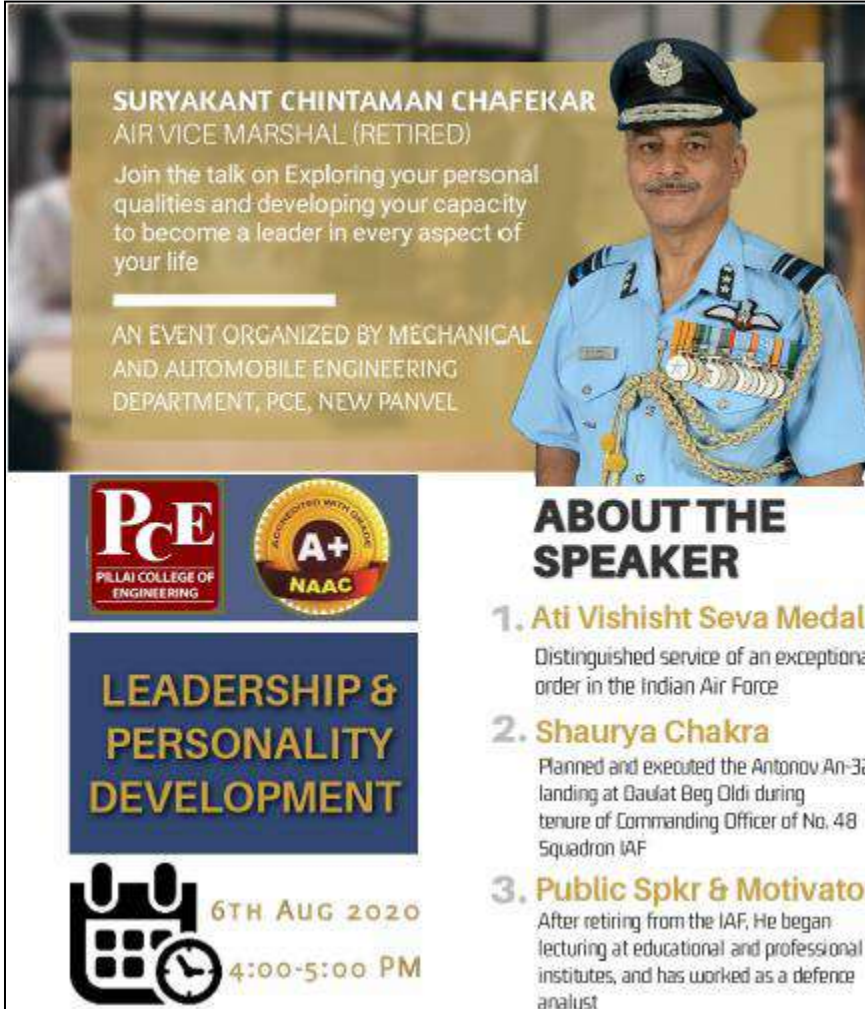

SURYAKANT CHINTAMAN CHAFEKAR
AIR VICE MARSHAL (RETIRED)

Join the talk on Exploring your personal qualities and developing your capacity to become a leader in every aspect of your life

AN EVENT ORGANIZED BY MECHANICAL AND AUTOMOBILE ENGINEERING DEPARTMENT, PCE, NEW PANVEL

PCE PILLAI COLLEGE OF ENGINEERING

ACCREDITED WITH GRADUATE **A+** NAAC

LEADERSHIP & PERSONALITY DEVELOPMENT

6TH AUG 2020
4:00-5:00 PM

ABOUT THE SPEAKER

- 1. Ati Vishisht Seva Medal**
Distinguished service of an exceptional order in the Indian Air Force
- 2. Shaurya Chakra**
Planned and executed the Antonov An-32 landing at Daulat Beg Oldi during tenure of Commanding Officer of No. 48 Squadron IAF
- 3. Public Spkr & Motivator**
After retiring from the IAF, He began lecturing at educational and professional institutes, and has worked as a defence analyst

Webinar on "Scope of Data Science"

A webinar to discuss the importance and scope of Data Science in the present scenario was organized on 8th August, 2020. The expert for the session was Mr. Pradeep Kumar who is a Team Manager in a private firm and has expertise in various programming languages. He has an experience of 10 years in predictive analysis. He made the participants aware of the importance of acquiring programming skills so as to meet the requirements of Industry 4.0. He also made them understand that it's today's need and has a bright future.



PCE
PILLAI COLLEGE OF
ENGINEERING

Mahatma Education Society's
**PILLAI COLLEGE OF
ENGINEERING**

Accredited 'A+' grade by NAAC

Department of Mechanical & Automobile Engineering
present

An Interactive session on
**Scope of
DATA SCIENCE**
with
Mr. PRADEEP KUMAR

About the Speaker:

- Team Manager at private sector firm
- Very strong background of programming languages
- Has 10 years of experience in Predictive Analysis.
- Holding a degree in Masters of Business Administration

Click below

To Join the Session

8th August 2020 3:00 pm - 5:00 pm
Saturday

R Programming Workshop

An online workshop on “R Programming” was organised from 13th August to 20th August, 2020 in collaboration with Spoken Tutorial which is an initiative of National Mission on Education through ICT, MHRD, Govt. of India to promote IT literacy through Free Open Source Software (FOSS). R is an FOSS and is a language and environment for statistical computing & graphics. A total 100 participants had registered for this online workshop. It was an opportunity to meet people and share the knowledge of 'R Programming' language and its usefulness for upcoming future. One of the participants from West Bengal secured 100% test score in the exam conducted by IIT-Bombay Spoken tutorial, two participants secured 95%, one participant secured 92.5% and two participants secured 90% in the certification test. Apart

from the spoken tutorial series on R programming, the workshop consisted of daily interactive session, assignments and quiz to assure effective learning. This was very much appreciated by the participants when compared to other similar workshops going on remotely.



PCE
PILLAI COLLEGE OF ENGINEERING

Mahatma Education Society's
PILLAI COLLEGE OF ENGINEERING
Accredited A+ grade by NAAC



Spoken Tutorial

Department of Mechanical Engineering &
Department of Electronics and Telecommunication Engineering
jointly offers

Workshop on **'R Programming'** through IIT-Bombay
Spoken Tutorial Platform

Keypoints

- Learn basics of 'R Programming' to start your journey with Data Science and Predictive Analysis
- Interactive sessions
- Online Tutorials
- Quizzes
- Assignment

Takeaways

- IIT - Bombay Participation Certificate
- IIT - Bombay Completion Certificate after Online exam
- PCE Participation Certificate

13th Aug -
20th Aug

FOR REGISTRATION
[CLICK HERE](#)

WORKSHOP FEE
MES Student and Faculty Rs. 200/-
Outside MES Student Rs. 500/-
Outside MES Faculty Rs. 700/-

Note : Rs. 300 and Rs. 500 for MES student and MES faculty respectively will be borne by Pillai College of Engineering

Workshop Coordinators
Prof. Shivapradeep Muthupandi
Prof. Florence Simon

Contact Number:
9987271794



Industry Institute Interaction on "Focus of Application Engineering for Mechanical Engineers"

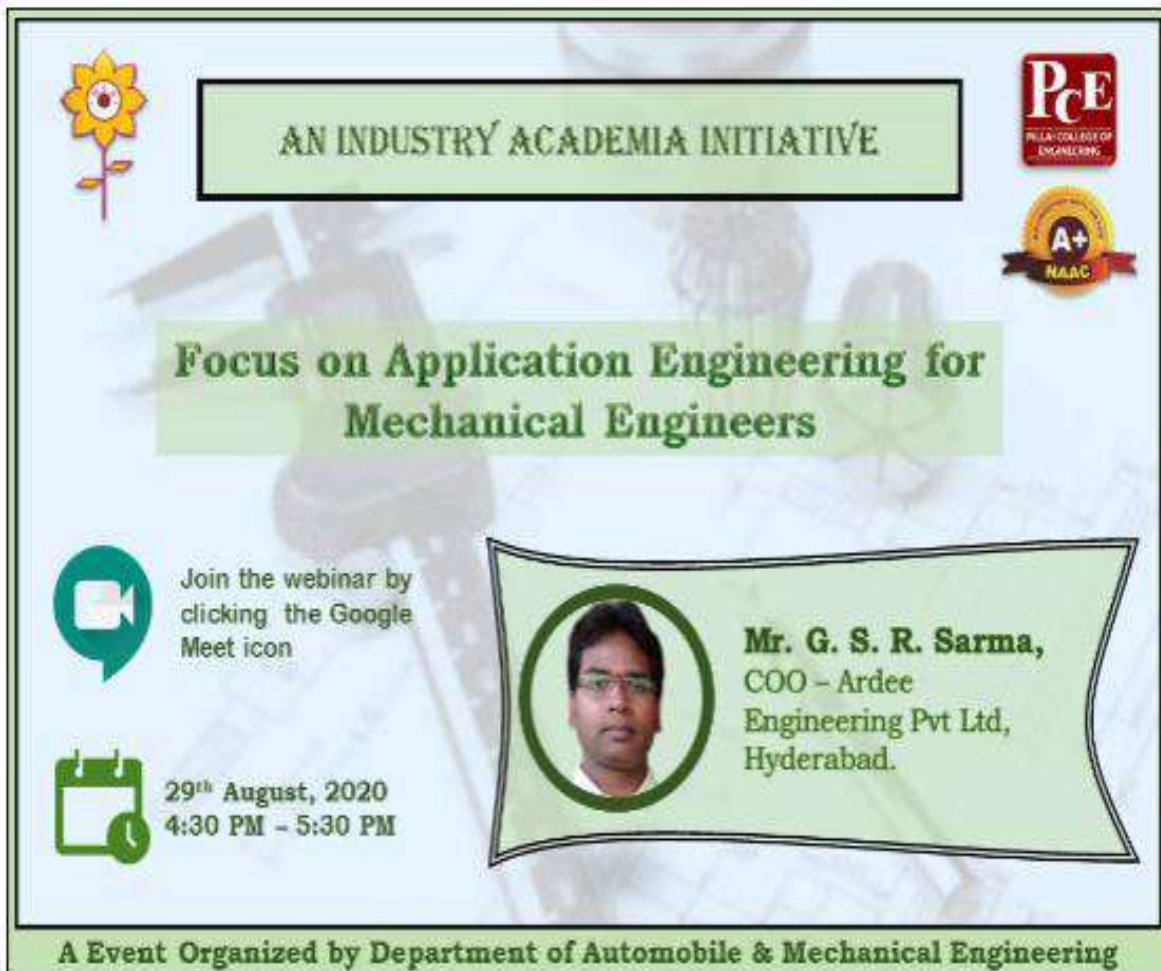

The graphic is a promotional poster for a webinar. It features a light blue background with a faint image of a person working at a computer. At the top left is a yellow flower logo. At the top right are the PCE logo and an NAAC A+ accreditation badge. A green box at the top center contains the text "AN INDUSTRY ACADEMIA INITIATIVE". Below this, a larger green box contains the title "Focus on Application Engineering for Mechanical Engineers". On the left side, there are two icons: a green speech bubble with a camera icon and a green calendar icon. Next to the speech bubble icon is the text "Join the webinar by clicking the Google Meet icon". Next to the calendar icon is the date and time "29th August, 2020 4:30 PM - 5:30 PM". On the right side, a green banner contains a circular portrait of a man and the text "Mr. G. S. R. Sarma, COO - Ardee Engineering Pvt Ltd, Hyderabad." At the bottom, a green bar contains the text "A Event Organized by Department of Automobile & Mechanical Engineering".

AN INDUSTRY ACADEMIA INITIATIVE

Focus on Application Engineering for Mechanical Engineers

Join the webinar by clicking the Google Meet icon

29th August, 2020
4:30 PM - 5:30 PM

Mr. G. S. R. Sarma,
COO - Ardee
Engineering Pvt Ltd,
Hyderabad.

A Event Organized by Department of Automobile & Mechanical Engineering

Value Added Course on "ANSYS"

A Value added course on "ANSYS" was organised from 29th August to 24th November, 2020 on an online mode. The course was conducted only on weekends. Utmost care was taken to make the sessions interactive so as to bridge the gap between online and offline mode and the participants have effective hands on experience. The course was framed on the basis of the response received from the students. The course was scheduled only on weekends. Registrations of only those participants were confirmed who could successfully install the freely available educational version of ANSYS available on their system. The course duration was approx. 50 hrs which was more than the planned schedule as it was executed to match the pace of learning of every student and few extra sessions were planned to cover all the content as per the schedule.

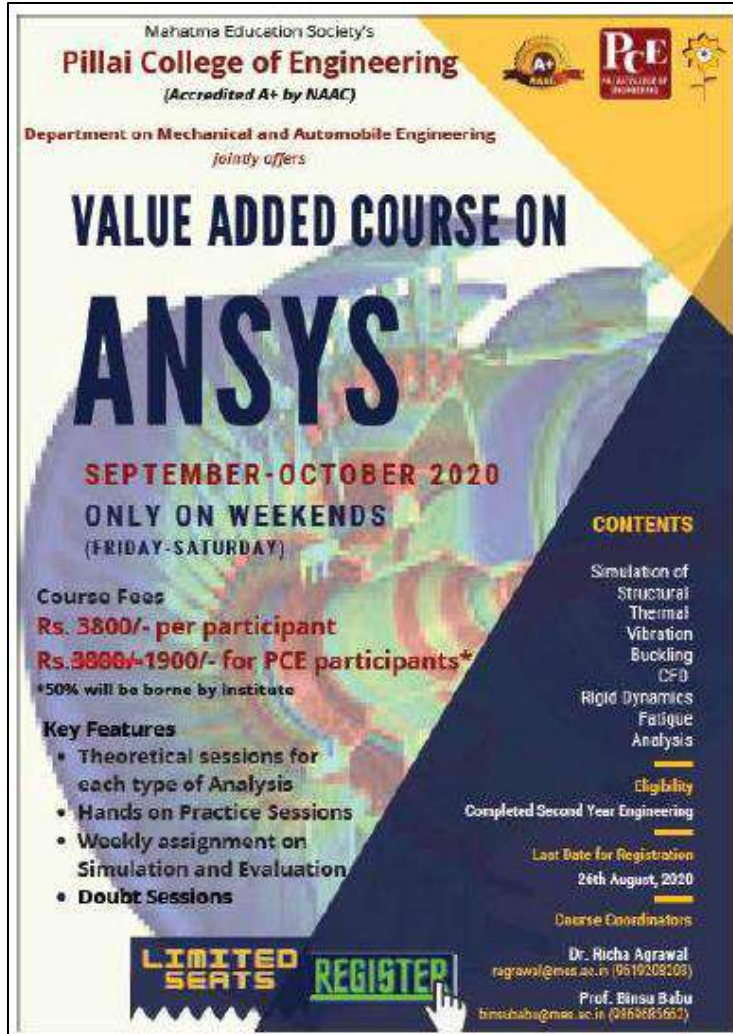

Mahatma Education Society's
Pillai College of Engineering
 (Accredited A+ by NAAC)

Department on Mechanical and Automobile Engineering
jointly offers

VALUE ADDED COURSE ON ANSYS

SEPTEMBER-OCTOBER 2020
ONLY ON WEEKENDS
 (FRIDAY-SATURDAY)

Course Fees
Rs. 3800/- per participant
Rs. 3800/- 1900/- for PCE participants*
*50% will be borne by institute

Key Features

- Theoretical sessions for each type of Analysis
- Hands on Practice Sessions
- Weekly assignment on Simulation and Evaluation
- Doubt Sessions

CONTENTS

- Simulation of Structural Thermal Vibration Buckling CDO
- Rigid Dynamics Fatigue Analysis

Eligibility
 Completed Second Year Engineering

Last Date for Registration
 26th August, 2020

Course Coordinators
 Dr. Richa Agrawal
 ragrawal@mes.ac.in (9619208203)
 Prof. Binsu Babu
 binsubabu@mes.ac.in (9367663652)

LIMITED SEATS REGISTER

Value Added Course on "Industry 4.0"

One month Value added course on “Industry 4.0” was organised from 29th August to 27th September, 2020 to enhance the knowledge and upgrade the skills of the participants in robotics and automation. The participants can learn the operation and control of robotic systems, the programming and understanding of the functionality of the advanced robots with hands-on experience to program and control robots remotely from home. They learnt about industry 4.0 concepts in automation, controls, deep learning, AI, image processing, manufacturing and many more. They were also introduced to the robot system with 3D Printing, Laser Engraving, Pen Drawing, Pick n Place, Gesture Control and lot more capabilities. The contents covered included Basics of Robotics, Manipulating Robots, Robot Anatomy, Coordinate System & Positioning, Control and Sensing of Robot. Hands on session were also given on Teach & Play, Pick n Place, Logical Block Diagram Coding, Python Programming, 3D Printing, Laser Engraving, Pen Drawing, Manual Joystick control and Gesture control. The 20 hour course was distributed over a period of 5 weekends (2 hours every Saturday & Sunday). The course was open to all branches and years of study and limited to only 20 students, only from PCE & PHCET shortlisted for the

first batch depending on marks scored in the quiz and other questions asked in google form. Students with PC/Laptop and good internet were preferred. Certificate of course completion were provided on the basis of course project, assignments, exam and overall performance. After completion of training, students showcased their project made during the training period with the hands-on practice of programming and controlling the robot remotely from their home.



**Robotics, Automation, PLC,
Image processing, Python
Deep Learning,**

Want to control a live robot from your home?

Pillai College of Engineering presents online facility "Pillai Industry 4.0 Lab" to enhance your knowledge and upgrade your skills in robotics and automation.

Learner shall be gaining Knowledge on

- Basics of Robotics
- Manipulating Robots
- Robot Anatomy
- Coordinate System & Positioning
- Control and Sensing of Robot
- Manipulators
- Nonlinear Control
- Different Types of Sensors Used in Robots
- Robot Intelligence and Programming
- Trajectory Generation
- Collision Free Path Planning
- Communication
- Robot Mapping

Controls:

- Manual & Joystick
- Gesture
- Python
- Block Diagram
- Teach and Play
- OpenCv

All in one robot:

- Pick & Place
- Pneumatic End Effectors
- Pen Drawing
- 3D Printing
- Laser Engraving
- Customise End Effector
- Color Recognition

Application

- Assembly Line
- Manufacturing Line
- Pharmaceutical & Medical
- Research & Engineering

Communication:

- Android & IOS
- Arduino, Raspberry PI
- Wifi, Bluetooth



The 20 hour course is distributed over a period of 5 weekends (4 hours every week). The batch will be limited to 20 students , only from PCE and PHCET on the basis of a quiz questionnaire. This course is open to all branches and any year of study. Certificate of course completion will be provided on the basis of course project, assignments, exam and overall performance. For registration fill this google form link.

<https://forms.gle/KRC1BfLxBMtZK6TA>

Course Fee:
Rs. 1000/- per participant
Rs. 0/- for MES participant *

*100% will be borne by Institute

Last date of registration: 25/08/2020
Batch-1 Course time: 29/08/2020 - 26/09/2020

CONTACT

Course Coordinator :	Student Coordinator :
Asst.Prof.: Salim Jafri	Sanket Dhone
8169659311	8291429856
salimjafri@mes.ac.in	
Website: www.pce.ac.in	



Mahatma Education Society's
Pillai College of Engineering







Project Presentation by Students

Industry Institute Interaction on "Corporate Entry - Attitude Matters"



Pillai College of Engineering
Department of Automobile & Mechanical Engineering





AN INDUSTRY ACADEMIA INITIATIVE

"CORPORATE ENTRY – ATTITUDE MATTERS"

Speaker :

Mangesh Bhalerao
General Manager QA
Systems Division
Burckhardt Compression (India)
Pvt. Ltd.



Join the webinar by clicking the Google Meet icon



5th Spetember, 2020
3:30 PM – 4:30 PM

A Talk for Industry Institute Interaction as organised on 5th September, 2020. The session expert was Mr. Mangesh Bhalerao, General Manager (QA Systems Division) Burckhardt Compression (India) Pvt. Ltd having 25+ years of experience in industry. He explained in detail step by step from education to industry how attitude matters in corporate skills. He also talked about What are

the various factors in which life in corporate industry depends on? & what can be done before knocking a door of corporate industry for career opportunity. The talk was attended by 83 students and faculty.

Value Added Course on "Electric Vehicle"



**Mahatma Education Society's
Pillai College of Engineering**
(Accredited A+ by NAAC)

Department of Automobile Engineering
Offers
Value Added Course
on
Electric Vehicles
SEPTEMBER-OCTOBER 2020
*(2 hour Live Sessions on Every Wednesdays
Evening starting September 9th 2020)*

Course Contents

- Introduction to EV Domain
- FAME Scheme
- EV Architecture
- EV Dynamics
- EV Batteries
- BMS
- Electric Drives and Motor selection
- Motor controllers
- EV Charging Infrastructure and Opportunities
- Opportunities in EV Domain
- EV Standards and many more

Eligibility
TE and BE Automobile Students

Last Date of Registration-
1st September 2020

Course Coordinator
Prof. Amey Marathe
ameymarathe@mes.ac.in
(8087915556)

Course Highlights
Hands on Activities on
1. Li-Ion Battery Chemistry calculations
2. Battery Pack Calculation
3. Motor Calculation
4. Range Calculation
5. Drive cycle Calculation

Register Now

Course Fees
Rs-3600/- 1800/- for PCE students*
*-50% Cost to be borne by Institute

The value added course on Electric Vehicle was conducted from 16th September to 28th November. The course content was planned keeping in mind the EV Infrastructure and technological developments in India. A total of 65 students who were from TE and BE Automobile registered for the Value added course. The Live Sessions were planned and conducted on Every Wednesday evening from 6pm to 8pm in which students participated enthusiastically. A separate Google classroom for the course was created and all course related Videos and Slides were uploaded for students' reference. Also students were given several SAE papers on the said topic which they found really interesting to read. The Course content covered

various aspects of EV Technology ranging from E Mobility Overview, EV Powertrain configurations, Range and Power specification, Energy storage systems, Electric Drive & Motor types along with EV Charging technology. A MCQ test was conducted on content covered in all sessions. A minimum of 60% passing criteria was set for earning a Certificate and all students successfully cleared the Quiz examination.

Webinar on "Role of PLM in Industry"



Mahatma Education Society's
Pillai College of Engineering

Department of Mechanical and Automobile Engineering
Presents

Industry Institute Interaction Talk Series

ROLE OF PLM IN INDUSTRY

Engineering / Manufacturing / IT

EXPERT - MR. SUHAS CHAUDHARI
ASSOCIATE CONSULTANT AT TATA CONSULTANCY SERVICES

12th September, 2020
11.30 am to 12.30 pm

[CLICK TO JOIN](#)

PLM
PRODUCT LIFECYCLE MANAGEMENT

PHASES
Development
Implementation
Realize

SELL
IDEA
SOFTWARE
MARKETING
Process SERVICE

Strategy
PLAN
PROCESS
DESIGN

SSAGE
Workflow

TRANSPORTATION

As a part of the Industry Institute Interaction Talk Series, a talk on “Role of PLM in Industry” was organized on 12th September, 2020 on an online mode. The expert for the webinar was Mr. Suhas Chaudhari who is an Associate Consultant at Tata Consultancy Services. The session was attended by faculty members and students of all years. Mr. Suhas Chaudhari has undergone

various trainings from Renowned Institutes and developed his soft skills in various programming and Modelling Softwares. He has a professional experience of over 17+ years which he has gained while working with various National and International companies since 2003 at various positions. He discussed the importance of PLM in today's Industrial development. He also explained the evolution of PLM along with the skills required for PLM and its future scope. The session was very informative. The session ended with queries from the participants which were addressed by the speaker.

Workshop on "Python"

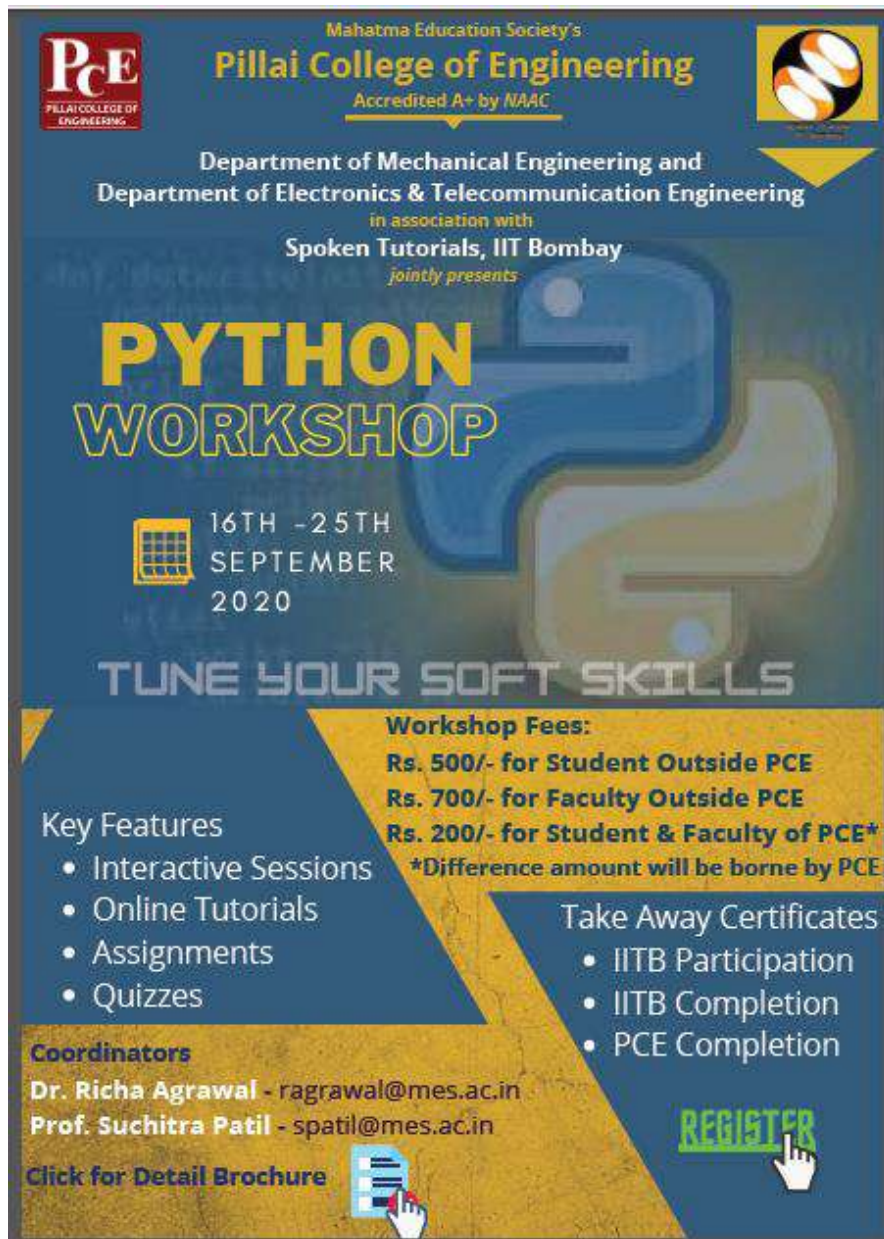

Mahatma Education Society's
Pillai College of Engineering
 Accredited A+ by NAAC

Department of Mechanical Engineering and
 Department of Electronics & Telecommunication Engineering
 in association with
 Spoken Tutorials, IIT Bombay
 jointly presents

PYTHON WORKSHOP

16TH - 25TH
 SEPTEMBER
 2020

TUNE YOUR SOFT SKILLS

Workshop Fees:
 Rs. 500/- for Student Outside PCE
 Rs. 700/- for Faculty Outside PCE
 Rs. 200/- for Student & Faculty of PCE*
 *Difference amount will be borne by PCE

Key Features

- Interactive Sessions
- Online Tutorials
- Assignments
- Quizzes

Take Away Certificates

- IITB Participation
- IITB Completion
- PCE Completion

Coordinators
 Dr. Richa Agrawal - ragrawal@mes.ac.in
 Prof. Suchitra Patil - spatil@mes.ac.in

Click for Detail Brochure 

REGISTER 

10 Days Online workshop on PYTHON was jointly conducted by Department of Mechanical Engineering and Department of Electronics and Telecommunication Engineering in association

with IIT Bombay - Spoken Tutorials, an initiative of National Mission on Education through ICT, MHRD, Govt. of India from 16th September to 25th September, 2020. Total 115 faculty and students from PCE and outside PCE across the nation registered for the workshop. Python is one of the world's most popular programming languages. The objective of the workshop was to start the journey of the participants towards Web Development, Data Science, Machine learning, scripting and many more. Python can be learnt by an individual from any background which zero programming knowledge. The program continued for 10 days. Schedule, Assignments and quizzes were released every day through Google classroom. Daily interactive sessions were conducted by coordinators in the evening, which covered content apart from that covered in the spoken tutorials. After successful completion and fulfilling the eligibility criteria, each participant received Completion Certification from PCE and participation and completion certificate from IIT Bombay.

Workshop on "QCAD"



Mahatma Education Society's
Pillai College of Engineering
Department of
Automobile & Mechanical Engineering
In Association with
Spoken tutorials IIT, Bombay





Q CAD

WORKSHOP



QCAD is a open source CAD software
application used for 2D design and drafting

Course Content:

- Draw & modify tools**
- Annotation**
- Basics 2D Drafting**

Workshop Fees:

Rs. 536 for students outside PCE

Rs. 790 for Faculty outside PCE

Rs. 200 for students of PCE *

* Difference amount will be borne by PCE

KEY FEATURES

- Interactive sessions**
- Practice Assignments**
- Online tutorials**

- IIT Bombay Participation certificate**
- IIT Bombay Completion Certificate after online exam**
- PCE Participation Certificate**

Date : 5th -10th
OCTOBER 2020
Time : 5.30 to 7.00

Limited seats available - Registration on first come first serve basis

Coordinators:

Prof. Ameya Nijasure (napradeep@mes.ac.in) - 7039062719

Prof. Binsu Babu (binsubabu@mes.ac.in) - 9869685662



Click to Register

Qcad is open source 2D drafting software. A workshop on QCAD was organised from 5th to 10th October, 2020 on an online mode. The course helped students to learn 2d drafting skills on open source platform. It can be utilized for various applications in future like for their mini Projects, PBL & final year project. Course content was designed for basics of 2d drafting with plenty of practice sessions provided to students. The participants appeared for the certification exam conducted by IIT Bombay Spoken Tutorial chapter

Five day online Faculty Development Program on "Emerging Materials and Nanotechnology"

Department of Automobile Engineering had organized a 5 Days Online FDP from 5th October to 9th October, 2020 on “Emerging Materials and Nanotechnology” under the theme “Novel Materials” which was sponsored by AICTE ATAL Academy. There were a total 215 registrations from different parts of the country. The FDP was inaugurated on 5th October in the presence of Chief Guest Dr. Parag Bhargava, Professor, IIT Bombay, Principal PCE Dr. Sandeep Joshi, Dean R&D Dr. P. S. Goyal, Heads of Department, faculty members and participants. Program Coordinator Dr. Divya Padmanabhan briefed about the importance of novel materials and the objectives with which the FDP was planned. The FDP was conducted on the Gotomeeting platform through the five days with three sessions on each day being delivered by resource persons from IIT, BARC and Industry. Daily quizzes were scheduled for the participants for effective learning. The valedictory session was held on 9th October from 4:15 pm onwards. The chief guest for the valedictory function was Dr. Lalitha Dhareshwar, Retired Head, Laser & Neutron Physics Division of BARC.

 MAHATMA EDUCATION SOCIETY'S Pillai College of Engineering, New Panvel 					
ATAL Sponsored Faculty Development Programme 5th – 9th October, 2020					
Title of FDP: Emerging Materials and Nanotechnology					
Time	Day 1 5 th Oct, 2020 Monday	Day 2 6 th Oct, 2020 Tuesday	Day 3 7 th Oct, 2020 Wednesday	Day 4 8 th Oct, 2020 Thursday	Day 5 9 th Oct, 2020 Friday
10.15 to 11 am	Inaugural Session	-	-	-	-
Session 1 (11am-12.15 pm)	Prof. Parag Bhargava (IIT Bombay) "Rethinking Research Impact: Case Studies on 'Successes' and 'Failures' in Particulate Materials Processing"	Prof. Sushil Mishra (IIT Bombay) "Superalloys in Aerospace applications"	Mr. Amit Medhekar "Stress Management/Relaxation Techniques"	Dr. Pankaj Patro (Sr. Scientist-BARC) "Materials Challenges and Opportunities in High Temperature Solid Oxide Electrochemical Cell Technology"	Dr. Dattaji K Shinde (VJTI Matunga) "Effect of Electrospun Nanofibers and Carbon Nanotubes on the Properties of Polymeric Composite as a Functional Material"
Lunch Break					
Session 2 (1.30 pm-2.45pm)	Dr. Priam Pillai (PCE) "Building Instruments to Test Novel Materials"	Dr P. S. Goyal (PCE) "Soft Matter and Experimental Techniques for Determining Sizes and Shapes of nanoparticles"	Dr. Gaurav Verma (Panjab University) "Serendipity in Nano- Materials Research"	Mr. Mohammed Yonus (Scientific Officer, BARC) "Development of Advanced Materials: Design, Processing and Characterization"	Dr. Lekha P (Charles University, Prague) "Advances in Photovoltaics: Third generation Solar Cells"
Session 3 (3pm-4.15 pm)	Mr. Suraj Rengarajan (CTO-AMAT India) "Materials Engineering to enable Global Infections"	Dr. Deepak Pattanayak (Senior Scientist-CSIR- CERI, Karaikudi) "Nanostructured 3Dprinted metallic implants for biomedical applications"	Dr. Saurabh Kapoor (Sterlite Industries, Aurangabad) "Looking through the glass: Science, Technology and Beyond"	Prof. Sastri Srikanth (JNCACR, Bangalore) "Mechanical behaviour and yielding of amorphous solids"	Dr. Divya Padmanabhan (PCE) " Nanoceramic synthesis using a novel approach"
4.15 - 4.45 pm	-	-	-	-	Valedictory and Feedback session



About the FDP

Technological advancements to a larger extent are possible because of the new materials and developments in their processing. Every era in history from stone age to iron age and even the present one is known by the material discovered or invented in that period. Materials have an indispensable role in every aspect of technology related to Mechanical Engineering, Production Engineering, Chemical Engineering, Biomedical Engineering, Electronics, Telecommunications, Automobile Engineering as well as many other disciplines. Nanotechnology has been a reality because of technologies and methods developed to produce materials in the nanosized range. Through this FDP participants would learn and participate in substantial knowledge sharing on the current trends and advances in New materials developments and Nanotechnology.

Objectives of FDP

This FDP aims to provide comprehensive knowledge of various functional and advanced materials, methods for their synthesis, testing, characterization, challenges as well as applications. This could be helpful to many faculty and researchers to identify the research avenues in the field of materials and would also be helpful in improving the quality of teaching contents being delivered.

Contents of FDP

- Nanotechnology and its implications
- Synthesis and Characterization of nanoparticles
- Polymer composites and their processing
- Ceramic Processing
- Nanocomposites and their characterization
- Mechanical Testing Techniques
- Composite development using Additive manufacturing
- Materials driven technologies in future

Who should attend

This Course would be beneficial to Faculty members from Engineering and Sciences, Research Scholars, as well as PG students. Professionals from Research Institutes and Materials Processing Industries would also find this useful.

Registration

For registration visit <https://www.aicte-india.org/atal>
 One can register for the course as per the specified process of AICTE Training and Learning(ATAL)Academy.
There is no registration fees for the FDP
Last date of registration: 1st October, 2020



Mahatma Education Society's
Pillai College of Engineering
 (Accredited A+ by NAAC)



All India Council for Technical Education
 ATAL Academy
 Sponsored
 Faculty Development Program
 on

**Emerging Materials and
 Nanotechnology**
 5th to 9th October, 2020

Coordinator
Dr. Divya Padmanabhan
 Professor-Automobile Engineering

Organized by
Department of Automobile Engineering
 Dr. K. M. Vasudevan Pillai Campus,
 Sector 16, New Panvel, Navi Mumbai,
 Maharashtra-410206
 Phone: 022-27456100/6030/1700
 Web site: www.pce.ac.in

Resource Persons

Eminent Academicians, Researchers from IITs, BARC and other well known Institutions across India as well as professionals from Materials Processing Industries.

Patrons

- Dr. K. M. Vasudevan Pillai
- Dr. Daphne Pillai
- Dr. Priam Pillai
- Mr. Franav Pillai
- Prof. Munawira Pillai
- Dr. Sandeep Joshi -Principal
- Dr. P.S. Goyal -Dean R&D

Advisory Committee

- Dr. Vivek Sunnapawar
- Dr. S. M. Khot
- Dr. Dhanraj P Tambuskar
- Dr. S. S. Bhusnoor
- Dr. Sanjay Bokade
- Dr. V. M. Phalle
- Dr. S. S. Pawar

Organising team

- Mr. Ameya Nijasure
- Mr. Binsu Babu
- Mr. Shivapradeep M
- Mr. Krishnamohan M
- Mr. George Varghese

For queries, Dr. Divya Padmanabhan divyamvp@mes.ac.in Mob: 9322839587
 Contact: Dr. Richa Agrawal Course Co-coordinator Mob: 9619208203

About Pillai College of Engineering

Pillai College of Engineering (PCE) was established in 1999 to provide quality education and develop industry ready engineers. PCE (formerly PIIT) is approved by AICTE, New Delhi; recognized by the Government of Maharashtra and DTE, and affiliated to the University of Mumbai. The College offers six Undergraduate programs, four Postgraduate programs and three Doctoral programs. In addition to these numerous value added and skill development courses are also offered. The College has been awarded 'A+' by NAAC, also accredited by NBA for three departments. The College is located in a lush green campus with state of art facilities and a stimulating educational environment. There is a Research and Innovation Centre in the campus which houses advanced equipments and setups funded by AICTE, DST, University of Mumbai and various industries.



About the Automobile Engineering Department

The Department of Automobile Engineering was established in 2009 to support and cater to the Automobile sector of the nation. The faculty in the department have specialization in various areas like Vehicle Dynamics, Autotronics, FEA analysis, Materials-Synthesis, Processing and Testing, Thermal Engineering and Advanced Manufacturing. The Faculty in the Department are actively engaged in research in specialized and emerging areas of Engineering and Technology. There are three Car Making Teams comprising of students who are engaged and facilitated by the faculty. Our graduates are placed with renowned Automobile manufacturing firms, other manufacturing companies and few have also become successful entrepreneurs.

Course Schedule

Dates: 5-9th Oct 2020
 Timings: 11.00am to 4.00pm

Note:

- The FDP will be on an online mode.
- Attendance and passing of quiz is mandatory for certification.
- Program Schedule and link for session will be shared after successful registration.

Course on Certified Solidworks Associate (CSWA) & Professional (CSWP)

Certified Solidworks associate professional is a global certification provided by Dassault systems. CSWP is a higher level of certification after CSWA. Basics of CAD modeling & Online platform for exam made it accessible in difficult COVID Situations. Mr. Tushar and Mr. Rahul from Addonix Technologies Pvt Ltd held initial session for introduction for CSWA and CSWP respectively followed by 15 more practice sessions by Pillai faculty members Prof. Binsu Babu & Prof. Ameya Nijasure. 35 Students and 26 Students from UG (SE, TE & BE), PG & PhD from Mechanical & Automobile Department enrolled for the CSWA and CSWP respectively course. All 35 students received CSWA Global Certification and out of 26 students, 21 students received global certification of CSWP.



**Mahatma Education Society's
Pillai College of Engineering, New Panvel
Dept of Automobile and Mechanical Engineering**

**Solidworks Mechanical design - Professional level
Certification Course (Batch - 1)**



Webinar Benefits

- Get a chance to appear for an online exam by Dassault System.
- 10 hrs training session from Dassault System.
- Access to more than 480+ training videos from Dassault System.
- 15+hrs of training session including practice sessions, doubt clearing sessions etc, from PCE faculty experts (Prof. Binsu B. & Prof. Ameya N.)
- E-certificate for participation to all.
- Dassault systems Solidworks Mechanical – Professional Certification for students who score 70%+ in online exam.

Chance to get Globally Certified in SolidWorks →



**Grab this opportunity at just
Rs.3000/-
(Rs. 8850/- 66% Discount)
Only for PCE students from Panvel**



HURRY only 35 seats.
(Registration first come first serve)
**Last date for Registration
27th Aug 2020**
**Course Duration
1st - 30th Sept 2020**

Nomination form link : <https://forms.gle/9AbPoc36tUhu46E9>

Kindly Note :

- Kindly note students enrolling for CSWP course should have cleared CSWA exam.
- Registration for 35 students will be done first come first serve basis.
- Students registering for the course should have Desktop/Laptop with good Internet Connection.
- Payment mode : Online (details will be provide to shortlisted students.)
- Remaining students will be added to waiting list. for now.

COORDINATORS

Prof. Binsu Babu - binsubabu@mes.ac.in (Mobile No:- 9859685662/9004447983)

Prof. Ameya Nijasure- najradeep@mes.ac.in (Mobile No:-7039062719)

Importance of CSWP Certifications

A webinar was organised for the first batch of CSWP certification appearing for exam in September 2020. Mr. Shaikh Abdullah discussed the importance of CSWP exam & various tips & trick of CSWP exam for the students. The session was very helpful for students as speaker appeared for same exam recently and shared his experience & approach for a successful attempt for CSWP Certification. The session was planned to build confidence in students who enrolled for CSWP exam.



**Mahatma Education Society's
Pillai College of Engineering, New Panvel**
Dept of Automobile and Mechanical Engineering
Presents a Webinar on

**Importance of
CSWP Certification Exam**

by
Mr. Shaikh Abdullah

Friday 18th September, 2020
9.00 AM – 10.00 AM

Google meet link : <https://meet.google.com/jbc-ujra-yhv>

Event Coordinators
Prof. Ameya Nijasure Prof. Binsu Babu

Segment 1

Segment 1: (11 questions)
70 Minutes – 75 points out of 105 points maximum
Mainly – solid modeling from sketch
Sketching, Equation based, material properties
Output: mass value

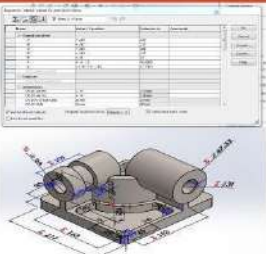

Segment 2

Segment 2: (12 questions)
50 Minutes – 77 points out of 105 points maximum
Mainly editing, Multi body, parts editing, advance tools
Output: Mass value
I had 3 separate models to work on:
First model - sketch editing, mirror, shell
Second model - equation, editing feature
Third model - configuration and design table



Webinar on "Towards Enabling Shape Memory Ceramics: Considerations for Stress Concentration Optimisation through Additive Manufacturing"

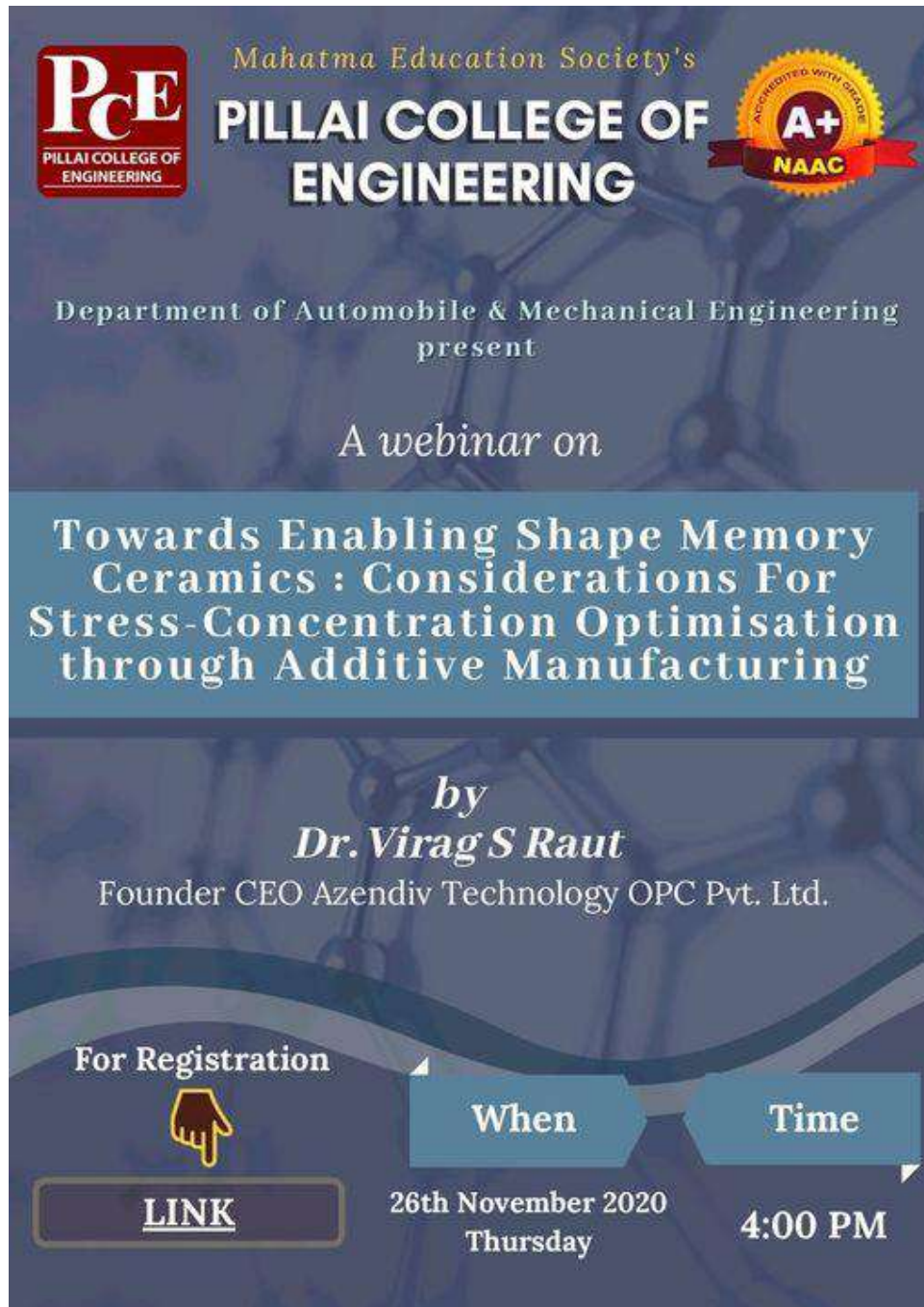

PCE
PILLAI COLLEGE OF
ENGINEERING

Mahatma Education Society's
**PILLAI COLLEGE OF
ENGINEERING**

ACCREDITED WITH GRADE
A+
NAAC

Department of Automobile & Mechanical Engineering
present

A webinar on

**Towards Enabling Shape Memory
Ceramics : Considerations For
Stress-Concentration Optimisation
through Additive Manufacturing**

by
Dr. Virag S Raut
Founder CEO Azendiv Technology OPC Pvt. Ltd.

For Registration



LINK

When
26th November 2020
Thursday

Time
4:00 PM

3 Days Workshop on "Report Writing"

3 days Report writing workshop was conducted successfully with 50+ participants for various institutes specifically for final year students of Pillai College of engineering. The primary objective of the workshop was to make the participants aware of the content to be included in the report for various types of project levels and also enhance the report quality made by the

students. Software used for to demonstrate report writing techniques was MS office Word. Hands on sessions were taken to make participants aware of all the features available in Microsoft Word required to make an effective report.



**Mahatma Education Society's
Pillai College of Engineering**
Accredited 'A+' by NAAC

Department of
Mechanical & Automobile Engineering
jointly presents

**3 DAYS WORKSHOP ON
REPORT WRITING**

 December 4th - 6th, 2020
2 Hours Daily

Major Content:

- Report basic structure
- University of Mumbai guidelines
- Creating sections, Table of Contents
- Formatting and editing in Word
- Markups
- Reference Citations

UG, PG, PhD students and Faculty can Register

Registration Fees - Rs. 100/- only
HURRY !!! Limited Seats

[CLICK TO REGISTER](#) 

Coordinators:
Dr. Richa Agrawal
- ragrawal@mes.ac.in
Prof. Amey Nijasure
- napradeep@mes.ac.in

Online Workshop on “Geometric Dimensions & Tolerance”

Geometric Dimensions & Tolerance workshop organised included four sessions basics concepts with practice exercises and industrial expert talk to bridge gap between industry – academia. Industrial expert Mr. Gulrez Khan, Senior Design and Analysis Engineer, Indofab Industries, Mumbai joined for last session to discuss actual application of GD&T in industry with case studies. All queries were answered in detail by industrial expert.

<p>Course Content</p> <ul style="list-style-type: none"> • Session 1 - Basic dimensions & Tolerances (Need, Definition, Rules & Application in solidworks) • Session 2 - Introduction to GD&T Basics (Need, GD&T Systems, Terms & Definition, Rules) • Session 3 - GD&T Symbols & Modifiers • Session 4 - Expert session on case studies - Application of GD&T 	<p>Industry Expert session by Mr. Gulrez Khan Senior Design and Analysis Engineer Indofab Industries Mumbai</p> <p>Workshop Fees: Rs 1500/- For outside participants Rs 750/- For Students of MES (PCE & PHCET) * Difference amount will be borne by PCE</p>	<p>Mahatma Education Society's Pillai College of Engineering </p> <p>Department of Automobile & Mechanical Engineering</p> <p>Geometric Dimensions & Tolerance (GD&T) in solidworks</p> <p>Course Duration : 15 - 20 hrs</p>		
<p>About Instructors</p> <table style="width: 100%; border: none;"> <tr> <td style="width: 50%; padding: 5px;"> <p>Prof. Ameya Nijasure Asst. Professor - Automobile Engineering - PCE</p> </td> <td style="width: 50%; padding: 5px;"> <p>Prof. Binsu Babu Asst. Prof. - Mechanical Engineering - PCE</p> </td> </tr> </table> <p>Globally Certified in Solidworks (CSWA & CSWP) Certified faculty instructor (AutoCAD, Solidworks, Ansys Workbench) Expert Domains : CAD modelling, Product design, FEA</p>		<p>Prof. Ameya Nijasure Asst. Professor - Automobile Engineering - PCE</p>	<p>Prof. Binsu Babu Asst. Prof. - Mechanical Engineering - PCE</p>	<p>Dates 30 - 31 Jan 2021 06 - 07 Feb 2021</p> <p>Session timings : 11 - 12.30 & 1.30 - 3.00</p>
<p>Prof. Ameya Nijasure Asst. Professor - Automobile Engineering - PCE</p>	<p>Prof. Binsu Babu Asst. Prof. - Mechanical Engineering - PCE</p>			
<p>Contact Details Prof. Ameya - 7039062719 Prof. Binsu - 9869685662 napradeep@mes.ac.in binsubabu@mes.ac.in</p>		<p style="text-align: center;">Click to Register</p> 		
		<p>Course Features</p> <ul style="list-style-type: none"> • Experienced instructors • Interactive sessions • Practice Assignments • Online tutorials • Industry expert session 		

Faculty Orientation Program on "Python Programming"

The Online Orientation Program on Python Programming (MEL 403/AEL 403) Revised Syllabus 2019 -'C' Scheme of Sem IV (Mechanical & Automobile Engineering) was held on 10th February, 2021. The objective of this orientation was to initiate interaction among faculty members teaching the subject with respect to scope, content to be covered and pattern of practical examination. Resource Person for the program was Dr.Priam Pillai from Pillai College of Engineering, New Panvel.



Faculty Orientation Program on "CNC & 3D Printing"

The faculty orientation program for Skill based Lab on CNC & 3D Printing, Second Year - Semester IV - Revised Syllabus 2019 -'C' Scheme, was held on 11th February, 2021 at 2.30 PM onwards. The program was inaugurated in the presence of Dr. Vivek Sunnapawar, Chairman Board of Studies, UoM, Dr. Dhanraj Tambuskar, BoS Member UoM and Head of Mechanical Engineering Department, PCE and Dr. Divya Padmanabhan, HoD Automobile Engineering, PCE. The resource persons for the program were Dr. R. Balasubramaniam Head, Design & Manufacturing Section, Control System Development Division, BARC, Mumbai and Dr. Nilesh Gongade, Associate Professor, M. H. Saboo Siddik College of Engineering. Dr. R. Balasubramaniam from BARC has discussed the importance and relevance of 3D printing with respect to industrial application. He suggested that metal 3D printing should be introduced to the

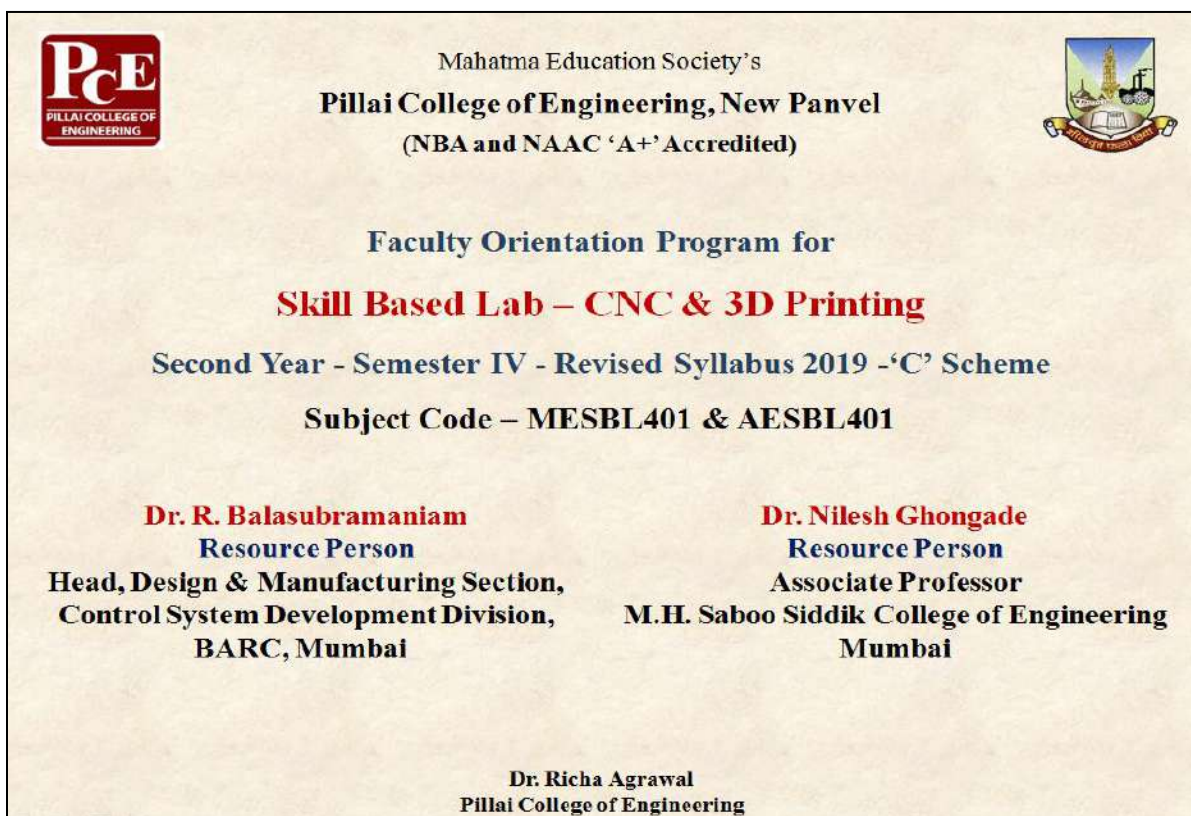
students. He also emphasized that the training and skill up gradation of the faculty is also needed for ensuring proper delivery of the content to the students.



Mahatma Education Society's
Pillai College of Engineering, New Panvel
(NBA and NAAC 'A+' Accredited)



Faculty Orientation Program for
Skill Based Lab – CNC & 3D Printing
Second Year - Semester IV - Revised Syllabus 2019 -'C' Scheme
Subject Code – MESBL401 & AESBL401

Dr. R. Balasubramaniam Resource Person Head, Design & Manufacturing Section, Control System Development Division, BARC, Mumbai	Dr. Nilesh Ghongade Resource Person Associate Professor M.H. Saboo Siddik College of Engineering Mumbai
---	--

Dr. Richa Agrawal
Pillai College of Engineering

ATAL Sponsored Faculty Development Programme on Product Design and Additive Manufacturing

5 days online Faculty Development Programme on “Product Design and Additive Manufacturing” was organized by Pillai College of Engineering New Panvel, Navi Mumbai, Department of Mechanical Engineering. There were a total 250 registrations from different parts of the country, 197 registrations were approved and 144 participants have attended the program. The FDP was inaugurated on 15th February at 9.30 am in the presence of Chief Guest Prof. Damodar Acharya, Former Chairman, AICTE New Delhi and Former Director, IIT Kharagpur, Dr. Sandeep Joshi-Principal PCE, Dr. P. S. Goyal-Dean R&D, Heads of Department, faculty members and participants. Prof. Acharya spoke about the importance of product design, various techniques of additive manufacturing and applications of 3D printing in various fields.



Mahatma Education Society's Pillai College of Engineering (Accredited A+ by NAAC)



AICTE Training and Learning (ATAL) Academy, New Delhi, Government of India Sponsored

Faculty Development Programme (FDP) on "Product Design and Additive Manufacturing"

15th to 19th February, 2021

Coordinator Dr. Dhanraj P Tambuskar Professor & HoD, Mechanical Engineering

Organized by Department of Mechanical Engineering Pillai College of Engineering, New Panvel Navi Mumbai-410206

About PCE

Pillai College of Engineering was started as Pillai Institute of Information Technology, Engineering, Media Studies and Research, and popularly known as PIIT in the year 2000. The name of the institute was changed as Pillai College of Engineering in the year 2016. The brand name of MES and the proactive steps taken by the institute for providing quality education and making industry ready engineers, made PCE as a leader in engineering education under University of Mumbai. The college has an enrollment of about 2700+ students in its 6 UG, 4 PG and 3 PhD Research Centers. PCE is known for interdisciplinary centers for excellence, infrastructure, value added courses, job-oriented training programs, project-based learning, maker spaces and the Festival of Joy- ALEGRIA. Four departments of PCE, Computer Engineering, Electronics Engineering, Information Technology and Mechanical Engineering were accredited by National Board of Accreditation, NBA, for 3 years from 2008. The college applied for NBA again in 2015 for its Computer, Electronics and Mechanical departments and received accreditation for 3 years. Subsequently in the year 2018, these three departments have been successfully reaccredited for next three years till 2021. Recently PCE has also been accredited by NAAC with A+ Grade.

PCE Website | MES Website Follow Us



About Mechanical Engineering Department

The Department of Mechanical Engineering was established in 2002 with a vision to develop world class program with excellence in teaching, learning and research.

Apart from the undergraduate program, the department also offers post graduate programs in CAD CAM and Robotics Engineering and Thermal Engineering and Doctoral program in Mechanical Engineering. Recently the department has been reaccredited by NBA.

The Faculty in the Department are actively engaged in research and consultancy projects and continuously receive grants from Government and Non-Government organizations like AICTE, University of Mumbai, New York State University, TCE, Highway Construction Co, Infinite Analytics India Pvt. Ltd, IDFC Institute etc.



About the FDP

Nowadays there is a great demand for customized products with shorter life-cycles, so quick adaptation for new product design and converting the design into product is an important issue to achieve competitive edge. The proposed FDP focuses on product design process, various methodologies for design, design factors and optimization for better performance of products. FDP will also emphasize on additive manufacturing, opportunities and challenges in it.

Course Content

- Product Design Process
Design Thinking
Reverse Engineering
Robust Design
Design Methodologies
Design for Manufacturing and Assembly
Design for Quality and Reliability
Additive Manufacturing
Case Studies
IPR and Patenting

Resource Persons

- Eminent Faculties from IITs, NITs and Other Institutes
Industries
Research Organizations
Domain expert faculties from PCE

Patrons

- Dr. K M Vasudevan Pillai
Dr. Daphane Pillai
Dr. Priam Pillai
Mr. Franav Pillai

Advisory Committee

- Dr. Sandeep M Joshi
Dr. P. S. Goyal
Dr. Divya Padmanabhan

Organizing Committee

- Dr. Gajanan Thokal
Dr. Richa Agrawal
Ms. Geeta Karmarkar
Mr. Shivapradeep M.
Mr. Amey Nijasure
Mr. Binsu Babu
Mr. Krishnamohan
Mr. George Varghese

Address for Correspondence

Dr. D. P. Tambuskar
Department of Mechanical Engineering,
Pillai College of Engineering, Sector-16
New Panvel, Navi Mumbai-410206
dhanrajt@mes.ac.in
Mob: 9323856590

Target Participants

The faculty members of the AICTE approved institutions, research scholars, PG Scholars, participants from Government, Industry (Bureaucrats/Technicians/Participants from Industry etc.) and staff of host institutions.

General Instructions

The confirmation of selection of participants will be intimated through email. The certificates shall be issued to those participants who have attended the program with minimum 80% attendance and scored minimum 60% marks in the test.

Registration Details

- For registration visit: https://www.aicte-india.org/atal
One can register for the course as per the specified process of AICTE Training and Learning (ATAL)Academy.
There is no registration fees for the FDP
Last date of registration:10th February, 2021
All further details for the FDP will be shared to the registered mail id after successful registration.

Day & Date	9.30 am - 10.00 am	10 am - 11.30 am	11.30 - 11.45 am	11.45 am - 1.15pm	1.15 - 2.15 pm	2.30 pm - 4.00 pm	4.00 pm - 5.00 pm
Monday 15 th February, 2021	Inaugural Function	Session 1 Design Thinking in Product Design Dr. Punit Tandon IITDM, Jabalpur	Tea break	Session 2 Innovation by Design Dr. B K Chakravarthy IIT Bombay	Lunch break	Session 4 Product Development Insights Mr. Narendra Pawar Aditi Applied Innovations Private Limited, Pune	-
Tuesday 16 th February, 2021	-	Session 3 3D Printing-A Disruptive Technology of this Era Dr. K P Karunakaran IIT Bombay		Session 5 Product Development and Protection under Various Aspects of IPR Mr. Suneet Sabole Brainiac IP Solutions		Session 6 Collaborative Design Dr. B K Chakravarthy IIT Bombay	-
Wednesday 17 th February, 2021	-	Session 7 Advances in Additive Manufacturing Dr. S S Mahapatra NIT Rourkela		Session 8 Case Studies on Biomedical Applications of 3D Printing Dr. L. Siva Rama Krishna UCE, Osmania University, Hyderabad		Session 9 Design and Development of Industrial and Strategic Components through Metal Additive Manufacturing Dr. U. Chandrasekhar Program Director, Adwiz Wipro 3D, Bangalore	-
Thursday 18 th February, 2021	-	Session 10 Experience the Stillness of the Mind Ms. Vandana Bangera Art of Living, Mumbai		Session 11 Reliability assessment and Allocation using Non Parametric Method Dr. B Rajiv CoE, Pune		Session 12 Design and Loss Optimization of Radial Magnetic Bearing Dr. S N Shelke SVIT, Nashik	-
Friday 19 th February, 2021	-	Session 13 Taguchi's Parametric Design Approach for Robust Product Design Dr. D P Tambuskar PCE, New Panvel		Session 14 Demonstration on 3D Printing and Other Facilities at PCE, New Panvel Dr. Richa A., Prof. Binsu B. & Prof. Ameya N. PCE, New Panvel		Session 15 Innovative Applications of 3D Printing Dr. L. Siva Rama Krishna UCE, Osmania University, Hyderabad	Valedictory Function

Value Added course on ANSYS



Mahatma Education Society's
Pillai College of Engineering
(Accredited A+ by NAAC)
Department on Mechanical and Automobile Engineering
jointly offers



VALUE ADDED COURSE

ANSYS

*Casestudies by International
Industry Expert*

FEBRUARY - MARCH
WEEKLY THREE DAGES
(EVENING 5.30 TO 7.30)

COURSE FEES
RS. 3500/- - ~~RS. 5000/-~~ (FOR PCE PARTICIPANTS)
RS. 5000/- (FOR OUTSIDE PCE PARTICIPANTS)

Key Features

- Case study from Industry Expert
- Theoretical sessions for each type of Analysis
- Hands on Practice Sessions
- Doubt Sessions

Last Date for Registration
25th January, 2021

HURRY
LIMITED SEATS

CLICK TO REGISTER

CONTENTS

Workbench and APDL
Simulation on
Structural
Thermal
Vibration
Buckling
Beam
Axis symmetry
Fatigue
Analysis

Course Coordinators

Dr. Richa Agrawal
rAgrawal@mech.ac.in (9866208009)

Prof. Binsu Babu
binsubabu@mech.ac.in (9866208009)

Prof. Ameya Nijasare
mreprod@mech.ac.in (9866208009)



Primary objective of this workshop was to make students aware about use of ANSYS as application of FEA. Course content was delivered on two different modules of ANSYS i.e Ansys APDL & Ansys Workbench with theory of each type of analysis in detail, Received positive feedback from participants on content planned, delivery techniques and hands-on sessions. Expert session from international industrial expert was arranged on “Industrial Applications of FEA”. In this session the expert explained different areas of application of ANSYS, benefits of using FEA & Practical approach.

Industry Expert Talk on "Exploring Opportunities in Non Destructive Testing"



PCE
PILLAI COLLEGE OF
ENGINEERING

Mahatma Education Society's
Pillai College Of Engineering
Accredited 'A+' by NAAC

Department of
Mechanical & Automobile Engineering

Presents

**Industry
Expert Talk**

on

**Exploring Opportunities
In
Non Destructive Testing**

by
Miss Anagha Bhide

 [Click here to join](#)

27th February, 2021
4:00 - 5:00 pm



Industry Expert Talk on "Opportunities Landscape for IT supported Manufacturing"

PCE
PILLAI COLLEGE OF
ENGINEERING

Mahatma Education Society's
Pillai College Of Engineering
Accredited 'A+' by NAAC

Department of
Mechanical & Automobile Engineering
Presents

**Industry
Expert Talk**
on
**Opportunities Landscape for
IT supported Manufacturing**
by
Mr. Sameer Wagh & Mrs. Savita Govilkar

 [Click here to join](#)
20th February, 2021
3:00 - 4:00 pm

Workshop on QCAD

Qcad is an open source 2D drafting software. The workshop helped students to learn 2d drafting skills on open source platform which can be utilized for various applications in future like mini Projects, PBL & final year project. Course content was designed for basics of 2d drafting with plenty of practice sessions provided to students.



Mahatma Education Society's
Pillai College of Engineering
 Department of
Automobile & Mechanical Engineering
 In Association with
Spoken tutorials IIT, Bombay





Q CAD WORKSHOP

**QCAD is a open source CAD software
application used for 2D design and drafting**

Course Content:

- **Draw & modify tools**
- **Annotation**
- **Basics 2D Drafting**

Workshop Fees:

Rs. 536 for students outside PCE

Rs. 790 for Faculty outside PCE

Rs. 200 For students of PCE *

* Difference amount will be borne by PCE

KEY FEATURES

- Interactive sessions
- Practice Assignments
- Online tutorials

- IIT Bombay Participation certificate
- IIT Bombay Completion Certificate after online exam
- PCE Participation Certificate

Date : 20th & 27th FEB 2021

Time : 11 to 12.30
1.30 to 3.30

Limited seats available - Registration on first come first serve basis

Coordinators:

Prof. Arneya Nijasure (arnadeep@mcs.ac.in) - 7035062739

Prof. Binsu Babu (binsubabu@mcs.ac.in) - 9869685662



Click to Register

Faculty Development Program on "Modern Manufacturing techniques"

3 days Online Faculty Development Program on “Modern Manufacturing Techniques” was organised from 4th March to 6th March, 2021. The program was intended to impart knowledge about the latest manufacturing techniques like CNC & 3D printing to the attendees. Hands on session on various packages like slicing software, image processing software and CAM software was organised by experts.



Mahatma Education Society's
Pillai College of Engineering
 NAAC A+ Accredited
 Department of Mechanical and Automobile Engineering
jointly offers

**3 DAYS ONLINE FACULTY DEVELOPMENT PROGRAM
 ON
 MODERN MANUFACTURING
 TECHNIQUES
 4TH-6TH MARCH, 2021**

Registration Fees : **Rs. 500/- only**
 Last date of Registration: **2nd March, 2021**

Tentative Schedule
 4th March - 2:30 to 5:30 pm - 3D Printing
 5th March - 2:30 to 5:30 pm - CNC Machines & Medical Image Processing
 6th March - 10.00 am to 5.00 pm - Unconventional Machining , CAD to CAM & Post processing

Note:
 • The content covered will be more application based so basic understanding of the theoretical concepts is a pre requisite for the program.
 • Registered participants will be instructed further to install required packages.
 • Content of Day 3 will be covered by Autodesk Certified Instructor.

REGISTER

Coordinator
DR. RICHA AGRAWAL
 r8@rawal@mes.ac.in, 9619208203



Webinar on “Job Opportunities in Plant Design and Engineering”

PILLAI COLLEGE OF ENGINEERING
Dr.K.M.Vasudevan Pillai Campus, Plot No.10, Sector 16
New Panvel East, Navi Mumbai, Maharashtra 410206.

In Association with
PIPETECH ENGINEERING SOLUTION PVT.LTD.
Organising

WEBINAR on

Job Opportunities in Plant Design & Engineering

WHO CAN ATTEND

Passed out & Final Year Appearing Students From
Mechanical, Civil, Automobile, Electrical Engineering Branch.

Key Highlights :

- Introduction to Plant Engineering
- Role Of Engineers in Plant Design
- Lucrative Career in Pipping Design
- Special Training Schemes
- Assured Job & Internships For Pillai's Students

Zoom Link

<https://pillai-edu-in.zoom.us/j/82884309029?pwd=VUV5T3NF0FQydGZvc3BIQ0VtMkh5Zz09>
Meeting ID: 828 8430 9029
Passcode: 953720

**Friday
19 March** | **4.00 Pm
To
5.00 Pm**

Report Writing Workshop

**Participants Feedback - Report Writing Workshop
Dec 2020**



"A very informative and valuable 3 days. The report writing workshop was incredibly useful to the students for writing their project reports."

Prof. Yogesh Keri
(Research Scholar)
PCE, New panvel



"As final year student workshop helped a lot to understand how to write technical reports with MS word software. Hands-on session was helpful to understand editing of reports."

Ms. Aishwarya Patil
(Final Year student)
PCE, New Panvel



"Hands-on training on word commands & tips will be helpful for writing any basic report. That reduced formatting and editing time significantly"

Prof. Bhavna Parab
(Research Scholar)
(PCACS New panvel)

Mahatma Education Society's
Pillai College of Engineering
Accredited A+ by NAAC



Department of
Mechanical & Automobile
Engineering

REPORT WRITING WORKSHOP

Topic Highlights:

- Report basic structure & language
- Creating sections, Table of Contents in MS Word
- Formatting and editing in MS Word
- Markups
- Reference Citations

DATE

March 27th - 28th 2021

Session timings
11.00 - 12.30 PM
1.30 - 3.00 PM

Registration Fees

Rs 100 /-	MES Students
Rs 200/-	Outside MES Students
Rs 300/-	Faculty/ Research scholars

 **REGISTRATION LINK**

Course Co coordinators

Dr. Richa Agrawal Associate Professor Department of Mechanical Engineering (ragrawal@mes.ac.in)	Prof. Ameya Nijasure Asst. Professor Department of Automobile Engineering (napradeep@mes.ac.in)
--	--

Industry Expert Talk on "Career in Operations and Supply Chain Management"



Mahatma Education Society's
Pillai College of Engineering
Accredited 'A+' by NAAC



Department of Mechanical and Automobile
Engineering
presents
INDUSTRY EXPERT TALK
On
Career in Operations and Supply Chain
Management
by
SAURABH LAD



3rd April 2021
11:00 am

[Click here to join](#)



Gate 2022 Orientation

Every year, lakhs of engineering aspirants compete for the GATE, therefore, it becomes very important for candidates to start their preparation early to stay ahead in the race. Since GATE is a highly competitive entrance exam, students need proper guidance for its preparation. Department has planned GATE coaching centre for the third-year undergraduate students of Mechanical and Automobile Engineering. Objective of the initiative was to create awareness about the importance of GATE in career development and growth, increase the number of Post Graduates aspirants and increase GATE qualified graduates.

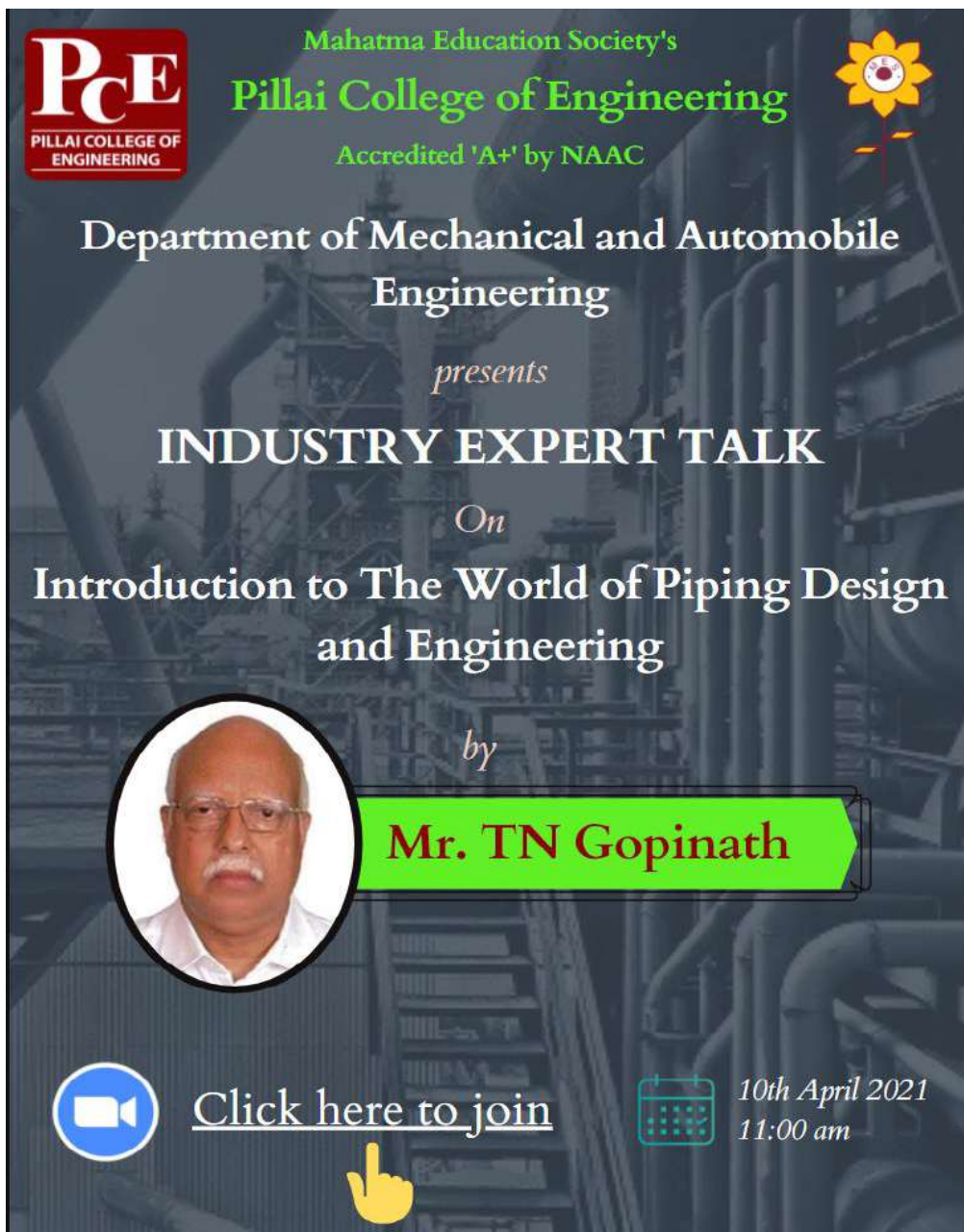

Industry Expert Talk on "Introduction to The World of Piping Design and Engineering"



PCE
PILLAI COLLEGE OF
ENGINEERING

Mahatma Education Society's
Pillai College of Engineering
Accredited 'A+' by NAAC

Department of Mechanical and Automobile
Engineering
presents
INDUSTRY EXPERT TALK
On
**Introduction to The World of Piping Design
and Engineering**
by
Mr. TN Gopinath

 [Click here to join](#)  10th April 2021
11:00 am



BE Project Competition



Mahatma Education Society's
Pillai College of Engineering
Dr. K. M. Vasudevan Pillai Campus,
Plot No. 10, Sector 16,
New Panvel, Navi Mumbai-410206

Department of Mechanical & Automobile Engineering organizing

BE PROJECT COMPETITION 2020-21

RULES & GUIDELINES

- ❖ Mode of Presentation is Online
- ❖ Each team can have maximum of Four members
- ❖ Participants should have valid ID card of their college
- ❖ Paper should be submitted in IEEE format
- ❖ E-Certificates will be given to all participants

Prize
1st 3000/-
2nd 2000/-
3rd 1000/-

Entry Fee
Rs. 200/-
(per group)

Projects from all Engineering stream can participate.

[Click here to Register](#)

Important Dates:

1. Last Date for Abstract Submission : April 1, 2021.
2. Competition Dates: April 16 - 17, 2021.

Coordinators

Dr. Gajanan N. Thokal
9892817386 (gthokal@mes.ac.in)
Prof. Krishnamohan S. Menon
7718057306 (mkrishna@mes.ac.in)
Prof. Manoj S. Bhamare
7387602003 (manojbhamare@mes.ac.in)

The Aims of this Online BE project Competition is to provide the best platform for students to present their Project work in front of the esteemed panel of judges. The competition was held on 16th and 17th April 2021. Total seventy groups from all over the nation have registered for the competition and around 280 students have participated. The judges are from industry and academies have evaluated all the seventy projects. Some of the panelists are Dr. Deshmukh from COE Pune, Mr. Debdatta Acharya from INCERTIES, Pune, Dr. Rukhande From FCRIT, Vashi, Dr. P.S. Goyal Dean R& D PCE, Dr. Nadar & Dr. G. V. Patil from HOC, Rasayani.

Prizes Winning Project Titles

First Prize Winner

Manufacturing a Turbocharged Motorcycle with Leading Link Forks Suspension system using Development Design

Second Prize Winners

- 1) Autonomous Inter-Row Weed Removing Robot
- 2) Design And Analysis of Two Speed Automatic Gearbox For Electric Vehicle

Third Prize Winners

- 1) Integrated Rapid Prototyping : Efficient Development of Custom Orthotics
- 2) Designing EV accumulator system & Using the AR platform for its Maintenance

Screenshots of Sessions:

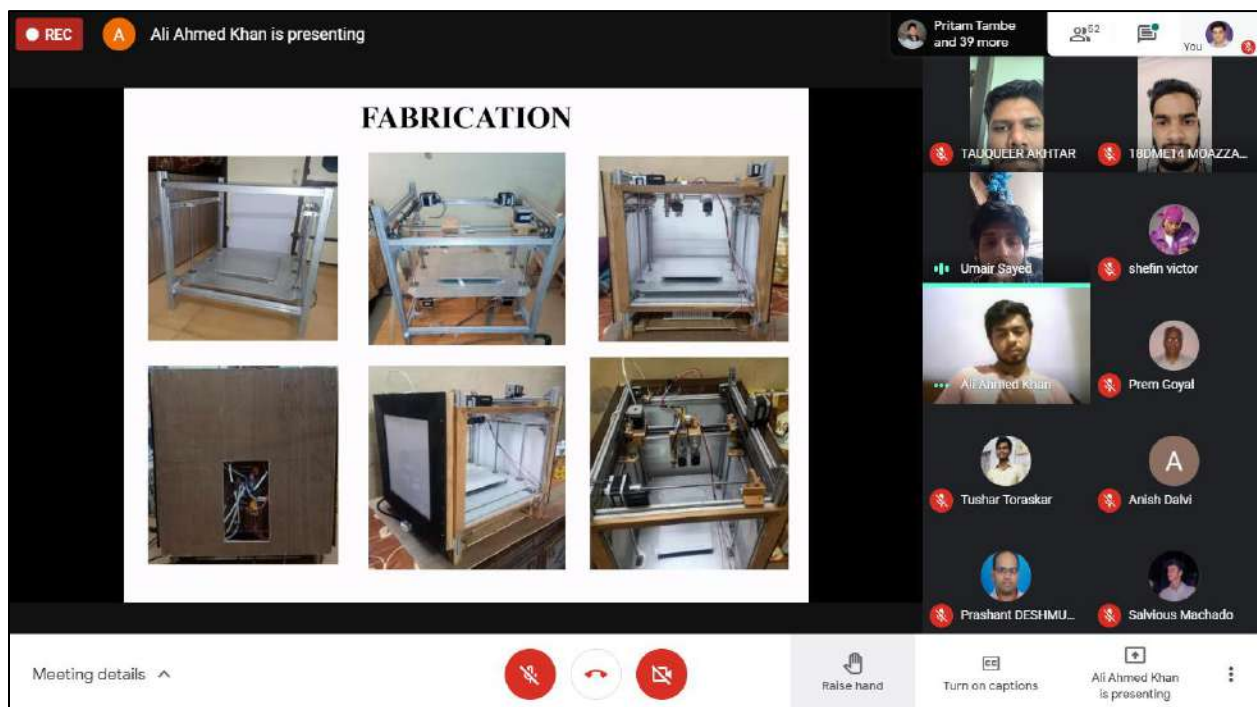
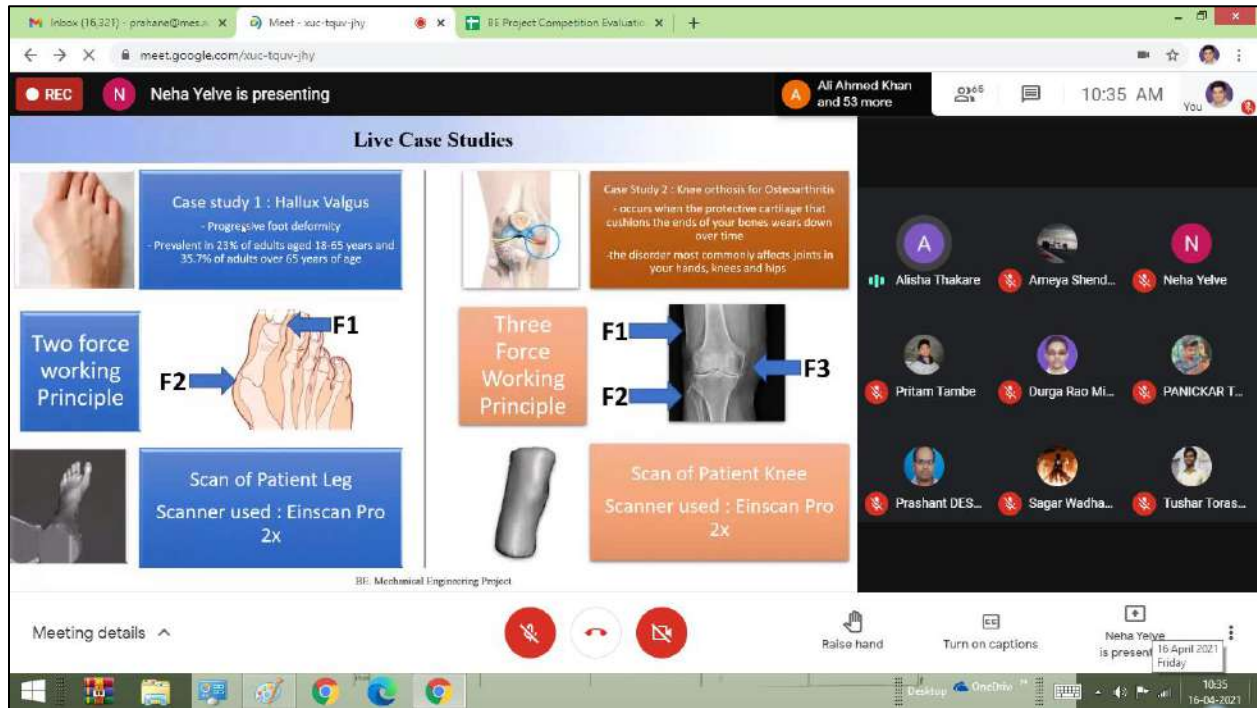

Industry Expert Talk on "Additive Manufacturing Digital Transformation & Robotics Automation"



The poster features a dark blue background with a faint image of a robotic hand holding a gear. At the top left is the PCE logo. To its right, the text reads: "Mahatma Education Society's Pillai College of Engineering Accredited 'A+' by NAAC". A yellow flower logo is in the top right. The main text in the center says: "Department of Mechanical and Automobile Engineering presents INDUSTRY EXPERT TALK On Additive Manufacturing Digital Transformation & Robotics Automation by Mr. Milind Deshpande & Mr. Hrishikesh Kolapkar". At the bottom, a calendar icon is next to the date and time: "24th April 2021 11:00 am". Two circular portraits of the speakers are shown: one with a yellow border and one with a green border.

PCE
PILLAI COLLEGE OF
ENGINEERING

Mahatma Education Society's
Pillai College of Engineering
Accredited 'A+' by NAAC

Department of Mechanical and Automobile
Engineering
presents
INDUSTRY EXPERT TALK
On
**Additive Manufacturing Digital
Transformation & Robotics Automation**
by
Mr. Milind Deshpande
&
Mr. Hrishikesh Kolapkar

 **24th April 2021**
11:00 am

2 Days Online FDP on "Online Content Development"

Faculty development program on Online Content development was successfully conducted on 1st & 2nd May 2021. Total 17 Faculty members joined for this FDP from various MES institutes and other institutes. Received positive feedback from participants as they felt more confident about recording videos on OBS Studio (Open source) & publishing them on YouTube understanding various basics while uploading Videos.



Mahatma Education Society's Pillai College of Engineering



Department
of
Automobile & Mechanical Engineering

Faculty Development Program

Online Content Development

Interactive sessions | Hands-on Training | Beginner level

Software / tools

OBS Studio (Opensource)
YouTube Basics

Session Dates & Timings

01 & 02 May 2021
11.00 - 12.30 & 1.30 - 3.00

Mode of Conduct :

Online (Googlemeet)



OBS Studio

- Installing OBS Studio on system
- OBS User Interface
- Basic Tools/settings in OBS
- Recording lecture on OBS
- Advanced Tools



YouTube Basics

- Starting YouTube Channel
- Uploading First Video
- Creator Studio / Analytics
- Tips & Tricks
- YouTube Policies



Who can Attend

- Faculty from UG/PG/PhD
- Faculty from Schools & Jr. Collage
- Education Based Content Creators

Workshop Fees:

Rs 400/- For MES Faculty
Rs 800/- For Outside MES Faculty

Course Coordinators

Prof. Ameya Nijasure

Asst. Professor - Automobile
Engineering - PCE
7039062719
napradeep@mes.ac.in

Prof. Kirshnamohan Menon

Asst. Professor - Mechanical
Engineering - PCE
7718057306
mkrishna@mes.ac.in



**Click
to
Register**



Python Workshop

PCE Pillai College of Engineering
Mahatma Education Society's
Pillai College of Engineering
Accredited 'A+' by NAAC

in association with
Spoken Tutorials, IIT Bombay

jointly presents
PYTHON WORKSHOP

Take Away
Certificates

- IITB Participation
- IITB Completion
- PCE Completion

Workshop will be conducted Online

Key Features

- Interactive Sessions
- Online Tutorials
- Assignments
- Quizzes

Workshop Fees :

Rs. 500 + Rs. 36 (GST) for Student Outside PCE
Rs. 700 + Rs. 90 (GST) for Faculty Outside PCE
Rs. 200/- for Student and Faculty of PCE*

*Difference amount will be borne by PCE

22nd March - 27th March
5:30 pm - 6:30 pm

Register

Course Coordinators

Prof. Aboli A. Khedkar aboli@mes.ac.in +91-9082969582	Prof. Sangeetha Selvan sangeethas@mes.ac.in +91-9869372973	Prof. M. Shivapradeep smuthupandi@mes.ac.in +91-9987271794
--	---	---



Department of Computer Engineering and Information Technology

Sr. No.	Name of Activity	Date	Organizers	Speaker
1	Orientation Program for "Data Structure " SEM III R19 C scheme	14 th July, 2020	Department	Dr.Sharvari Govilkar
2	Expert Talk on " Reach new speeds to insights with speech analytics "	18 th July, 2020	Dr. Sushopti Gawade	Dr. Hemant Palivela
3	Industry Expert talk on "Introduction to Deep Learning "	25 th July, 2020	Prof. Varunakshi B	Mr. Harshall Lamba
4	ONLINE orientation program on GATE Exam Preparations and Counseling for Third year and Final year students	31 st July, 2020	Department	Prof. Sunil Shelke , Assistant professor Dept of Computer Engg
5	Industry Expert talk on "Career in Cyber Security"	1 st August, 2020	Dr. Sushopti Gawade & Prof. Sheetal Gawande	Mr. Nikhil Mahdeshwar
6	Industry Expert talk on "Insights on Software Testing industrial approach"	8 th August, 2020	Dr. Sushopti Gawade & Prof. Varunakshi Bhojane	Ms. Pragati Chowhan , Manager , Training and competencies ,Tristha global Pvt Ltd
7	Webinar on Project Deep Blue by Mastek and Majesco's	21 st August, 2020	Department	Mr. Akhil Singhal,
8	Industry Expert talk on "Insights on Evolving Database Technologies"	12 th Sept 2020	Department	Mr. Sumit Zha
9	Online Workshop on "PHP & MySQL"	28 th September – 4 th October, 2020	Mr. Amol Kharat Ms. Blessy Varghese Mr. Dhiraj Amin	Mr. Amol Kharat, Ms. Blessy Varghese Mr. Dhiraj Amin Spoken Tutorials
10	Webinar on "Agile Software development'	7 th November, 2020	Dr.Prashant Lokhande	Ms.Taru Mittal and Mr. Ajaykumar
11	Industry Expert talk on "Transition from Campus to Corporate"	20 th Feb, 2021	Department	Miss. Aditi Sharma

12	Coder of the semester : season 3	10 th April, 2021	Department	Prof. Dhiraj Amin, Prof. Ranjita G, Prof. Amol K, Prof. Blessy V, Prof. Varunakshi B ., Prof. Aju P
13	Alumni Expert talk on Architecture Design of Jio from Planning to Implementation'	24 th April 2021	Department	Mr. Nikhil Kumar , Automation nnetwork solution Architect,

Orientation Program for the Subject “Data Structure “SEM III R 19 C Scheme Computer Engineering

As per guidelines provided by University of Mumbai, the Computer Engineering Department of Pillai College of Engineering (PCE) organized Online Orientation Program for the subject "DATA STRUCTURES (CSC303) and DATA STRUCTURES LAB (CSL301)", for sem III (Rev 2019 'C' Scheme), Computer Engineering branch, on 14th July 2020 from 03:00 pm to 5.00 pm. 90 participants attended the orientation program. The orientation program was conducted by Dr. Sharvari Govilkar, Head of Department Computer Engineering. She is a Member of Board of Studies Information Technology University of Mumbai. She has 23 years of experience in teaching. She was Subject convenor for the orientation program. Prof. Tabrej Khan from Kalsekar, Technical Campus and Prof. Jignasha Dalal from KJ Somaiya college Sion were resource persons for this orientation program. The subject convenor and resource persons clarified all the queries put forward by the various participants.

Pillai College of Engineering, New Panvel, Navi Mumbai

PCE IS ACCREDITED BY NAAC WITH "A+" GRADE
THREE PROGRAMS ACCREDITED BY NATIONAL BOARD OF ACCREDITATION

Faculty Orientation Program for Second Year Computer Engineering Revised Syllabus-
Rev 2019 'C' Scheme
ON
DATA STRUCTURES (CSC303)
&
DATA STRUCTURES LAB(CSL301)
Organized by
PILLAI COLLEGE OF ENGINEERING
&
UNIVERSITY OF MUMBAI

Venue: Online using Google Meet
Date: 14th July 2020, 3 pm to 5 pm
Registration Link: <https://forms.gle/NPOCb8kVvUW3YqH9>

Dr. Sharvari Govilkar Subject Chairperson (9819261265)	Prof. Tabrej Khan Resource Person (9004673010)	Prof. Jignasha Dalal Resource Person (7021290487)
--	--	---

Expert Talk on “Reach New Speeds to Insights with Speech Analytics”

On 18th July 2020 expert talk was conducted for the students and speaker was Dr. Hemant Palivela who is Head AI/ML at eClerx Ltd. Total 195 participants benefited from the talk. The talk focused on the importance of speech analytics for organizations. Part of the issue is that speech analytics isn't “just” software. It's an innovative methodology that can alter the way we think about solving problems. At least it has that potential, but newbies get caught up in their limited definition of what constitutes a problem.



**Mahatma Education Society's
Pillai College of Engineering**

**Department of
Computer Engineering &
Information Technology**
Presents
Webinar on

**“REACH NEW
SPEEDS TO INSIGHTS
WITH SPEECH ANALYTICS”**

18TH JULY 2020
2:00-3:00 PM

Join the Telegram Link for more information
<https://t.me/joinchat/Op8fjB0T7rnAllwPy6NZyw>

Subscribe this Channel to watch Live Stream
<https://www.youtube.com/channel/UCdKxihUON7VxHQUt24cyjqQ>

About the speaker





DR. HEMANT PALIVELA
Head, AI & ML,
eClerx Services Ltd.

Dr. Hemant Palivela is Head of AI and Machine Learning at eClerx Services Ltd. After spending nearly seven years working with renowned organisations like NMIMS and Aureus Analytics, he shifted to Centre of Excellence, Digital Analytics Division of eClerx where he works on Campaign Analytics, Speech Processing, Generation and Recommendation Systems. His principal areas of interest with reference to theoretical frame include, Machine learning optimisation, linear algebra, probability theory and practical frame include, drug discovery, insurance analytics and recommendation systems. He has published around 35 plus research papers in International Conference and Journals.





Industry Expert talk on "Introduction to Deep Learning"

**Mahatma Education Society's
Pillai College of Engineering**

About Speaker



Mr. Marshall Lamba is a Data Scientist at Vidooly Media Tech. After spending more than five years as a software engineer with Amdocs, he shifted to pursue his Master's in Computer Engineering with special focus on Machine Learning. Then he joined TCS and is now working at Vidooly for the past one year. He works mainly as researcher and developer in the field of Computer Vision and Artificial Intelligence. His areas of interest are Algorithmic Optimization, Video Analytics, Natural Language Processing, Banking and Security. His favourite hobby is teaching and he has worked with Pillai College of Engineering as Lecturer for three years.

**Department of Computer
Engineering and Information
Technology
Presents
Webinar on**

**"Introduction to
Deep Learning"**

25th July 2020

10:00 AM - 11:00 AM

Join the Google Meet Link

meet.google.com/opz-eceo-crg

Watch the Live Stream



<https://rb.gy/r3d1sq>

To introduce the booming technology Deep Learning to students' industry expert talk was organized. The expert was PCE alumni Mr. Harshal Lamba who is currently designated as a Data Scientist at Vidooly Media Tech. to share his knowledge and experience. Talk was organized on 25th July 2020. Mr. Harshal explained thoroughly about the concept of deep learning and also solved the doubts and attended all the queries presented by the participants. More than 80 participants could take advantage of the session. This webinar focused on the Introduction to deep learning and a quick insight to machine learning through various examples. The speaker also explained about parts of speech tagging, Screen text detection (OCR), etc.

An ONLINE Orientation Program on GATE Exam Preparations & Counseling for Third and Final Year Students of Computer Engineering & Information Technology Department

On 31st July 2020 an online orientation program was conducted on GATE Exam Preparations & Counseling for Third and Final Year Students of Computer Engineering & Information Technology Department. Mr. Sunil Shelke of Computer Engineering department, PCE conducted and coordinated the event successfully. More than 230 students benefited from the program. The webinar was organized as an orientation program for 3rd and final year students of Computer Engineering and Information Technology departments at Pillai College of Engineering, New Panvel. The talk focussed on the GATE Computer Science paper and was aimed at introducing GATE to intended target students. Following points were covered and discussed.

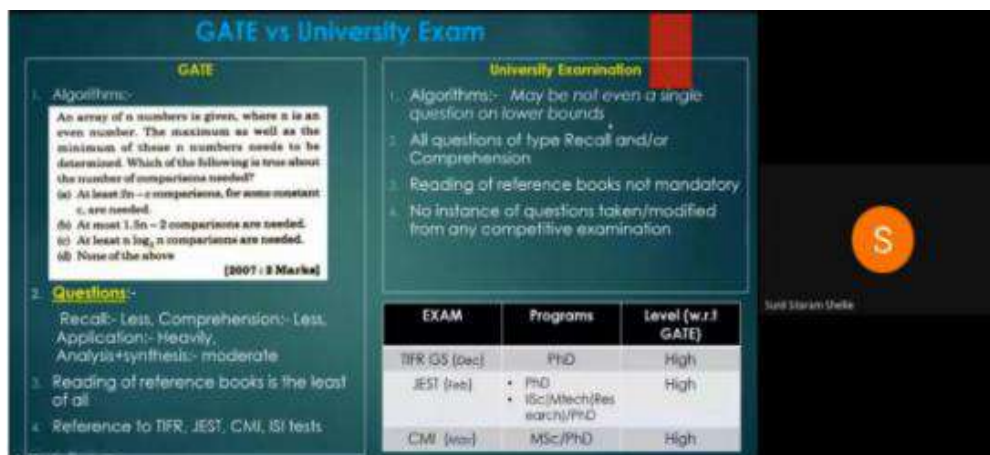
- GATE: - General introduction, GATE 2021 updates and examination dates
- Use of GATE score for employment in India and higher study abroad
- Use of GATE score for Master and PhD programmes at IITs, IISc, TIFR, IIM, ISI, IISER and other reputed institutes in India
- GATE-CS examination details: - Syllabus, Exam Structure, Marks Distribution, Score & Validity, brief statistics of GATE-CS 2020
- Dept. of Computer Engineering & Information Technology preparation plan for GATE-CS 2021
- Differences between GATE and university examinations
- Financial incentives for considering GATE-CS examination
- Orientation webinar ended with a few suggestions for achieving a good result in GATE.



GATE vs University Exam

EXAM	Programs	Level (w.r.t GATE)
TIFR (Dec)	PhD	High
JEST (Feb)	• PhD • IISc/Mtech/Res each/PhD	High
CMI (Mar)	MSc/PhD	High

Industry Expert Talk on "Career in Cyber Security"

An industry expert talk was organized on “career in cyber security” by the computer and Information Technology engineering department on 1st august from 1pm to 2pm. Organizer and coordinator Prof. Sheetal Gawande invited the speaker for a one hour session. Speaker for the session was Mr. Nikhil Mahadeshwar who is working as Proprietor at Feather’s. Session was conducted using an online platform. Total 100 participants attended the session. Session started at 1pm sharp and continued till 2pm. At 2 pm a Valedictory function was held to thank the speaker for sharing his knowledge. Speaker was given a vote of thanks along with the head of departments. The talk focuses on the “Career in cyber Security”. Mr.Nikhil introduced the various career opportunities in the cyber security field. He first discussed various case studies in cyber security and what was the impact of it on our life, business etc. He explained about the importance of certification and various certification courses that students can perceive. He also discussed different internship opportunities that students can have with their company.



Mahatma Education Society's
Pillai College of Engineering

Department of
Computer Engineering &
Information Technology

Presents
Industry Expert Talk On
CAREER IN
CYBER SECURITY
BY NIKHIL MAHADESHWAR

1ST AUGUST 2020

1:00-2:00 PM

Google Meet: <https://meet.google.com/yos-xrzi-ngv>
Stream : https://stream.meet.google.com/stream/Link_a7bae9ef-27a5-4e62-a3a6-5dbc976d4c86
<https://www.youtube.com/nikhilmahadeshwar>

About the speaker



MR. NIKHIL MAHADESHWAR

He started his career in web industry in 2007 after SSC, he was just 16 that time, he then started working as a freelancer web developer for 1 year. He Established his own firm. As in web industry he started research in it. His web research is especially in:

1. Ethical Hacking & Information Security
2. 150 Years of future world report form 2010 to 2150
3. Social Media Marketing for SME's & PLE's

Designations & Achievements:

1. Proprietor at Feather's Group
2. Founder of Cyber Secured India
3. Director at Coure Ongo Pvt. Ltd.
4. EC council Certified Security Analyst & Computer Hacking Forensics Investigator
5. Member of Cyber Attack Community, Asian School of Cyber Law, Pune
6. Official Visiting Faculty of Maharashtra Entrepreneurship Development Program (Maharashtra Govt.)
7. Digital Volunteer of Social Media Cell, Ministry of Information & Broadcasting, New Delhi, Govt. of India.
8. Achieved youngest entrepreneur award from MBC
9. Presented as youngest researcher in National conference of social media responsibility.
10. Trained more than 30,000 people on various subjects & lectures to Entrepreneurs, school & college students, Police officials, corporates, etc.

CYBER SECURITY



Industry Expert talk on "Insights on Software Testing Industrial Approach"



Mahatma Education Society's
Pillai College of Engineering



Department of
**Computer Engineering &
Information Technology**
Presents
Industry Expert Talk on
**"INSIGHTS ON
SOFTWARE TESTING
INDUSTRIAL APPROACH"**
BY PRAGATI CHOWHAN

8TH AUGUST 2020
2:30-3:30 PM

<https://meet.google.com/qpy-wasp-vnb>

ABOUT THE SPEAKER:



PRAGATI CHOWHAN
Manager,
Training and Competencies,
Tristha Global Pvt. Ltd

She has over 10 years of experience in teaching and 5 years of experience in software testing domain. She has worked as Assistant Professor in different Universities like Sant Gadge Baba Amravati University and Savitribai Phule Pune University. She has also been a Training & Placement coordinator during her teaching curriculum. She has been a Corporate Trainer in software testing for nearly 5 years. Currently she is Manager of Training and Competency development at Tristha Global Pvt. Ltd, Mumbai. She has completed her Bachelor of Engineering as well as Master of Engineering from Sant Gadge Baba Amravati University and Master of Business Administration in E-business from Prin. L.N. Welingkar Institute of Management Development & Research, Mumbai. She also holds International Software Testing Quality Board's Foundation Level certification. She is a Life Member of Indian Society for Technical Education since 2013. She has also published many research papers on Identifying the Quality of Object-Oriented Software System in various National and International Journals as well as conferences.





On 8th August 2020 using google meet online platform industry expert talk was organized by Computer Engineering and Information Technology departments. Topic for the talk was “Insights on Software Testing Industrial Approach”. Speaker for the session was Ms. Pragati Chowhan who is designated as Manager at Trishta Global Pvt. Ltd. 79 students attended the session. This talk focuses on the “Industrial Approach of Software Testing”. Ms Pagati introduced the various career opportunities in the Software Testing field. She discussed various topics like SDLC, Testing hierarchy, Testing management and different case studies in software testing. She also highlighted the importance of this course in industry, business etc., importance of certification and various certification courses that students can perceive and different internship opportunities that students can have with their company.

Webinar on Project Deep Blue by Mastek and Majesco's

On 21st August 2020, Computer Engineering & Information Technology Department in association with CSI-PCE for all departments of Pillai College of Engineering conducted a webinar on Deep Blue Competition. The session was conducted on the online platform Google Meet from 5:00 P.M. - 6:30 P.M. Mr. Akhil Singhal, data scientist at Mastek and the program manager of Deep Blue was the speaker for the event. The webinar was free for all students and aimed at enlightening the students about the Deep Blue competition which serves as a platform that bridges the gap between industry and academia. The webinar was attended by 160 students and 5 faculty members. The event record shows almost a constant of 165+ views.

The webinar was scheduled to start at 5:00 P.M. Introduction of speaker was given followed by the speech of Prof. Aju Palleri, who elaborated on the importance of the Deep Blue Competition. The speaker’s session concluded at 5:35 P.M and the question-answer session began.

The Mastek initiative - Project Deep Blue, is an intercollegiate competition, encouraging engineering students to solve social problems using coding skills to come up with meaningful technical solutions over the course of three months.

The problems that the student teams will be working on to come up with a solution are:

1. Crowd Counting Challenge(CCC)
2. Predict Queue Wait time (PQT)
3. Air Quality Visualization (AQV)

4. Automation Society Security Task (ASST)
5. Geofencing Using IoT(GOT)



Industry Expert talk on "Insights on Evolving Database Technologies"

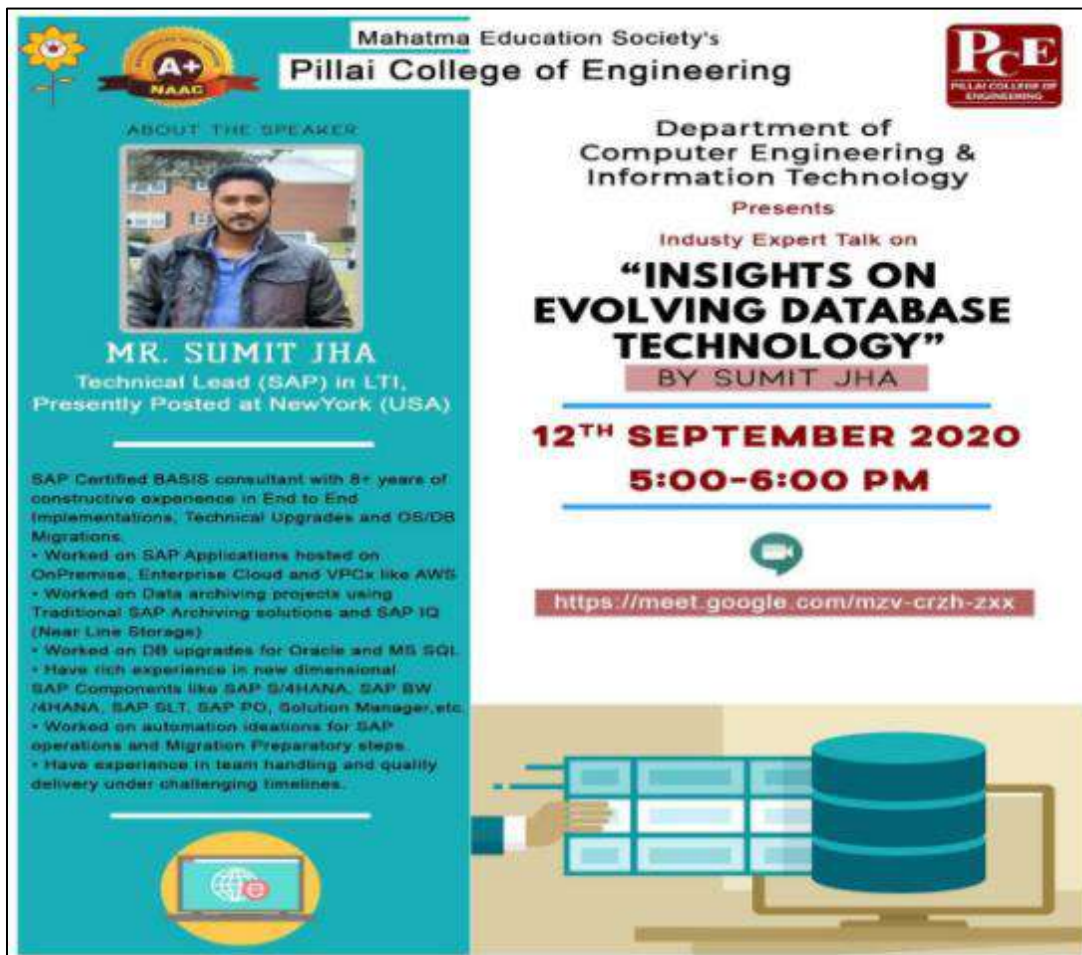

The poster is for an event organized by the Department of Computer Engineering & Information Technology at Pillai College of Engineering. It features a profile of Mr. Sumit Jha, a SAP Certified BASIS consultant. The event is titled 'INSIGHTS ON EVOLVING DATABASE TECHNOLOGY' and is scheduled for 12th September 2020, from 5:00-6:00 PM. A Google Meet link is provided at the bottom.

Mahatma Education Society's Pillai College of Engineering

Department of Computer Engineering & Information Technology
Presents
Industry Expert Talk on
"INSIGHTS ON EVOLVING DATABASE TECHNOLOGY"
BY SUMIT JHA

12TH SEPTEMBER 2020
5:00-6:00 PM

<https://meet.google.com/mzv-crzh-zxx>

ABOUT THE SPEAKER

MR. SUMIT JHA
Technical Lead (SAP) in LTI,
Presently Posted at NewYork (USA)

SAP Certified BASIS consultant with 8+ years of constructive experience in End to End implementations, Technical Upgrades and OS/DB Migrations.

- Worked on SAP Applications hosted on OnPremise, Enterprise Cloud and VPCs like AWS
- Worked on Data archiving projects using Traditional SAP Archiving solutions and SAP IQ (Near Line Storage)
- Worked on DB upgrades for Oracle and MS SQL
- Have rich experience in new dimensional SAP Components like SAP S/4HANA, SAP BW /4HANA, SAP SLT, SAP PO, Solution Manager, etc.
- Worked on automation ideations for SAP operations and Migration Preparatory steps
- Have experience in team handling and quality delivery under challenging timelines.



An industry expert talk was organised on 12th Sept. 2020 and the eminent speaker for the session was Mr. Sumit Jha. 120 students attended and benefited from the expert talk organized. The talk focused on the importance of evolution of different database technologies. Speaker talked about the importance of databases in organizations. It was very clearly explained how the need to change database patterns and formats evolved as per organization requirements. Speaker explained SAP database technologies in detail. He introduced SAP HANA database technology use in industry.

Online Workshop on "PHP & MySQL"

The Online workshop on PHP & MySQL was organised by the Department of Computer Engineering and Department of Information Technology, Pillai College of Engineering, New Panvel in association with IIT Bombay - Spoken Tutorials. The Workshop was conducted from 28th Sept, 2020 to 04th Oct, 2020 and attended by 206 participants. Students from PCE as well as other colleges participated and 6 faculty members also did registration and completed the workshop successfully.

Key Points of Workshop:

- Daily Quizzes
- Daily Assignments to be uploaded on GitHub
- Daily interaction sessions for doubt clearing
- IIT Exam
- Conducted on 30 Jan 2021.
- 175 participants attempted the exam & 170 cleared the exam.
- Top score - 81.9 %
- Participants received certificates from IIT (after completion of exam) and from PCE.



PCE
PILLAI COLLEGE OF
ENGINEERING

Mahatma Education Society's
Pillai College of Engineering
Accredited A+ by NAAC

**Spoken Tutorials
IIT Bombay**

**Department of Computer Engineering and
Department of Information Technology**
in association with
Spoken Tutorials, IIT Bombay
jointly presents

PHP and MySQL

ONLINE WORKSHOP

28TH SEPTEMBER - 3RD OCTOBER 2020

Key Points

- Interactive Sessions
- Online Tutorials
- Assignments, Quizzes

Take Away Certificates

- IITB Participation
- IITB Completion after exam
- PCE Completion

Workshop Fees:
Rs. 500/- for Student Outside PCE
Rs. 700/- for Faculty Outside PCE
Rs. 200/- for Student & Faculty of PCE*
*Difference amount will be borne by PCE

Click Here To Register

Click For Detailed Brochure

Coordinators
Prof. Amol Kharat - akharat@mes.ac.in
Prof. Blessy Varghese - bvarghese@mes.ac.in
Prof. Dhiraj Amin - amindhiraj@mes.ac.in

Webinar on "Agile Software development"

A webinar was organized on "Agile Software Development" by Dr. Prashant Lokhande in collaboration with TCS on 7th Nov. 2020. Speakers for the event were Ms. Taru Mittal who is currently Heading TCS's Corporate IT Agile Transformation Network and Mr. Ajay Chouhan who is working as Ninja Agile Coach, TCS's Corporate IT Agile Transformation Network. 130 participants registered for the webinar. Webinar was informative and was a grand success. The talk focuses on the importance of agile development technologies. Speaker talked about the importance of agile development in organizations. It was very clearly explained how the need to adopt agile technologies as per organization requirements. Speakers explained in detail the importance and concepts related to agile technologies.



A+
NAAC

Mahatma Education Society's
Pillai College of Engineering

PCE
PILLAI COLLEGE OF
ENGINEERING

Department of
Computer Engineering &
Information Technology

Presents

Webinar on

**"AGILE SOFTWARE
DEVELOPMENT"**

7TH NOVEMBER 2020

11:00 AM-12:30 PM

Join Zoom Meeting
ID: 77828355625
Password: Dj04L6hDdj
Passcode: Dj04L6hDdj

Speakers:

MS. TARU MITTAL
Head, TCS's Corporate
IT Agile
Transformation Network

MR. AJAY SINGH CHOUHAN
Ninja Agile Coach, TCS's
Corporate IT Agile
Transformation Network



Industry Expert talk on "Transition from Campus to Corporate"

Department of Computer Engineering and Information Technology organized the industry expert talk on transition from campus to corporate on 20th Feb. 2021. The speaker for the event was Ms. Aditi Sharma, an alumna of Pillai College of Engineering and currently working as a Consultant at LTI. 65 participants registered for the event. The talk focused on the importance of transition from college to corporate culture. Speaker advised logical reasoning and programming skill set to be developed among students during college time. To enhance technical ability as well as soft skill development some certifications will help them for better aspects in industry. It was very clearly explained how the need to change in attitude from college to corporate is useful for their career. Speaker also elaborated the selection process to get in corporate for students.



**Mahatma Education Society's
Pillai College of Engineering**

**Department of
Computer Engineering &
Information Technology**
Presents
Industry Expert Talk on
**"TRANSITION FROM
CAMPUS TO CORPORATE
WORLD"**
BY ADITI SHARMA
**20TH FEBRUARY 2021
4:00-5:00 PM**

ABOUT THE SPEAKER



ADITI SHARMA
Consultant at LTI

Aditi Sharma is a B.E graduate from Mumbai University in Information Technology. She aspires to work on real world projects and solve problems. Always keen to know new technologies and innovations, and has done certification courses in Python and Java. Presently she is working with LTI and developing skills under SAP C4C as a consultant. Received 'Innovative Implementable Idea (I²) Award as among top 25 teams in India - SAMHAR-COVID19 Hackathon (May 2020)

zoom

<https://pillai-edu-in.zoom.us/j/88041295442?pwd=TE9rVEIjUVNMcHU2SIRXSFNjZnp4dz09>

Meeting ID: 880 4129 5442
Passcode: 762292



Coder of the Semester: Season 3

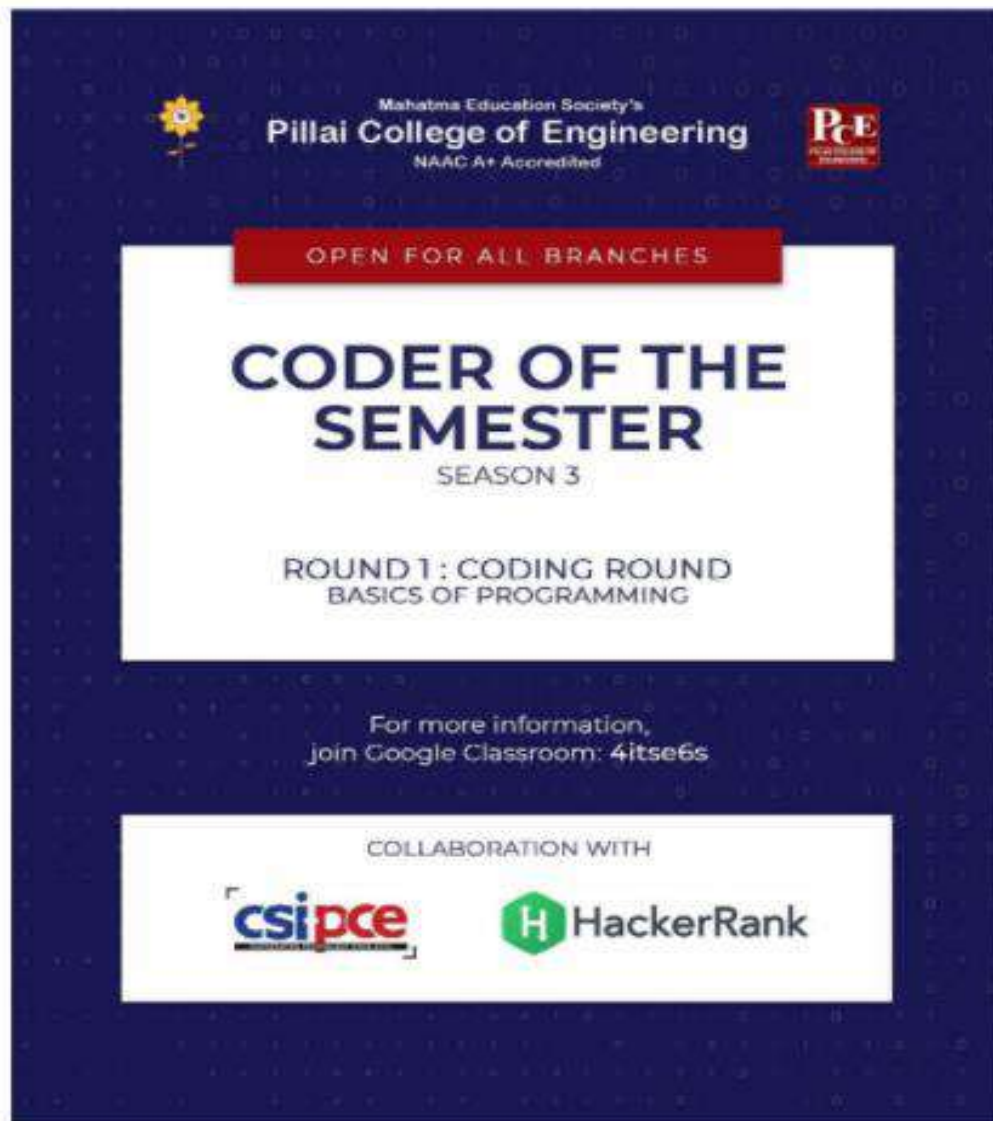

Coding is an integral part of Computer Engineering and Information Technology Students. Nowadays many IT Companies before campus placement ask students to attend their respective online coding competition. The coding problems in such competitions are basically different from experiments which are carried out in the academic course. By attending various online coding competitions students gain immense knowledge and improve their coding and logical thinking skills.

Coder of the Semester is a coding Competition conducted for all students of Pillai College of Engineering in collaboration with CSI PCE. Coder of the semester season 3 consists of three rounds. The first round is an open round and all the participants are promoted to the second round which is elimination round and from the second round top 10 participants are selected for the final round.

Coder of the semester season 3, first round was conducted based on coding problem statements.

In the first round 5 coding problems were given to the participants, which they need to solve in an hour. The first round was completely based on coding and was conducted in HackerRank. Contest was common for FE students and other year students of Pillai College of Engineering. For Fe, SE, TE and BE students total 205 students signed up for the contest. Students were given the option to solve the problem in their choice of programming language. Aditya Nair from TE COMPUTER ENGINEERING was the winner of the first round and he successfully submitted solutions for all the five problems.

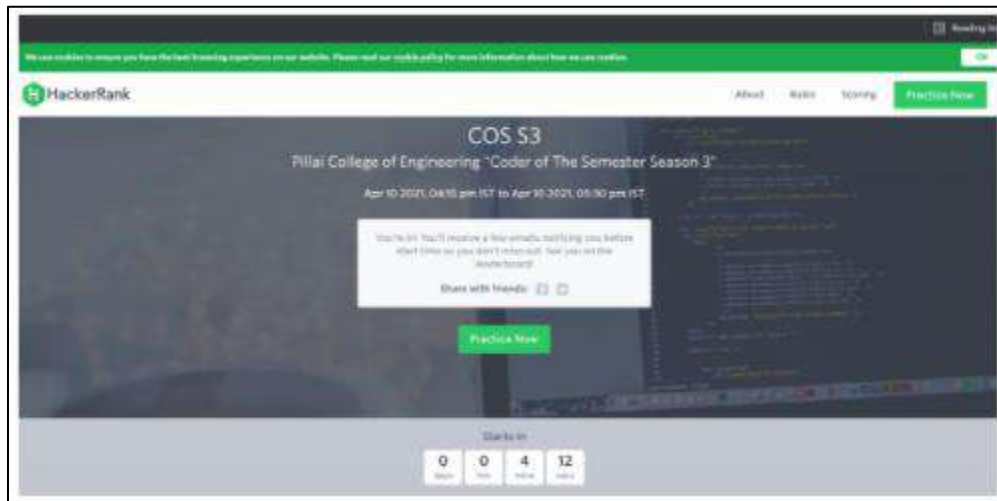

Contest Page on HackerRank Platform

Contest page was made available on the HackerRank platform for the students to create excitement amongst all the students participating in the competition. The participants were also provided with a “Practice Now” option in order to prepare themselves for the upcoming competition. Following is the contest flyer circulated amongst the students of First, Second, Third and Final year of engineering students of Pillai College of Engineering.

Alumni Expert talk on Architecture Design of Jio from Planning to Implementation

Department of Computer Engineering and Information Technology, Pillai College of Engineering, New Panvel organized a talk on “Architecture Design of JIO from Planning to Implementation” on 24th April, 2021. The speakers briefed about the Complete Architecture Design of Jio and detailed the process from planning to implementation. The expert for the session was Mr. Nikhil Kumar Automation Network Solution Architect Cisco Systems Inc. working for Clients Jio, Airtel



Mahatma Education Society's
Pillai College of Engineering

Department of
Computer Engineering &
Information Technology

Presents
Industry expert talk on

**“ARCHITECTURE DESIGN
OF JIO FROM PLANNING
TO IMPLEMENTATION”**

24TH APRIL 2021

11:00 AM ONWARDS

Click on the below link to join the webinar
<https://pillai-edu-in.zoom.us/j/89926501477?pwd=NEpQYzJBRmdGZG1tUjRzVlhqQ24vQT09>

Meeting ID: 899 2650 1477
Passcode: 062406

MR. NIKHIL KUMAR
Automation Network
Solutions Architect
Cisco Systems Inc
• Working for Clients - Jio, Airtel

Department of Electronics and Telecommunication Engineering and Electronics and Computer Science

Sr. No.	Name of Activity	Date	Organiser	Speakers
1	Opportunities and Careers in Power electronics	18 th July , 2020	Sneha K. Chikodi	Mr. S.D.Naik
2	Industry Expert lecture on Reliance JIO 4G Architechure	18 th July , 2020	Suchitra A. Patil	Mr. Saurabh Srivastava
3	Look forward to a brighter future	19 th July, 2020	Suchitra A. Patil	Mr. Vinit Sonawane, Mr. Manish Watkare, Mr. Aashay Dubey
4	Industry Expert lecture on Future in Cloud Services	25 th July , 2020	Ameet M. Mehta	Mr. Saurabh Kulkarni
5	Industry Expert lecture on Communication in Automation now a days and it's future in coming days	1 st August, 2020	Tusharika S. Banerjee	Mr.P.S.Salunkhe
6	Industry Expert lecture on Introduction to RFID and industrial applications	1 st August, 2020	Shishir Jagtap	Mr. Ketan Kolge, B.Tech IITB, CEO of RFTS and Koham Pvt Ltd.
7	Industry Expert lecture on Network Threats and Cyber Security	1 st August, 2020	Harsha Ghadge	Mr. Shubham Jangid, Commedia Solutions
8	Industry Expert Lecture on Database and Analytics Scope in IT World	12 th September 2020	Aboli A. Khedkar	Mr. Saurabh Deo, Accenture
9	Future educational opportunities and job opportunity in machine learning and A.I.	15 th August, 2020	Sonali Kathare & Jayshree Bhosale	Mr. Saurabh Mahajan
10	EXTC Journal Launch	20 th August 2020	Team Journal EXTC	Students Committee members
11	Workshop on "Python"	16 th to 25 th September, 2020	Dr. Richa Agrawal, Prof. Suchitra Patil	Dr. Richa Agrawal, Prof. Suchitra Patil, Spoken Tutorial
12	Workshop on R programming	13 th to 20 th August, 2020	Prof. Shivapradeep Muthupandi and Prof. Florence Simon	Prof. Shivapradeep Muthupandi and Prof. Florence Simon

13	RF ASICs Design Using CST	27 th October, 2020	Dr. Avinash R. Vaidya and Dr. Shishir Jagtap	Mr. Kartik Goyal
14	Talk on Networking Fundamentals	8 th Nov, 2020	Prof. Sonali Kathare, Prof Harsha Sharma	Mr. Sachin Gupta
15	Impulse Based Time Domain Technique for Hidden Target Detection	13 th Feb, 2021	Suman P.Wadkar	Dr. Shivraj Rathod
16	GATE 2022 Training for Third Year Engineering	18 th March -12 th April, 2021	Department	All faculty from Department
17	Python Workshop	22 nd to 27 th March, 2021	Aboli Khedkar, Prof. Sangeetha Selvan, Prof. M. Shivapradeep	Aboli A. Khedkar, Prof. Sangeetha Selvan, Prof. M. Shivapradeep
18	Introduction to Networking and Cyber security	27 th March, 2021	Prof. Ravi Biradar	Mr. Tanmay Pradhan
19	SQL for data science	11 th April 2021	Aboli A. Khedkar	Aboli A. Khedkar
20	Networking and Communication	17 th April, 2021	Sonali Kathare & Jayshree Bhosale	Mr. Utsav Katira
21	Career path in Software development	24 th April, 2021	Sonali Kathare & Jayshree Bhosale	Mr. Abhishek Datar
22	Development in Latest Digital technologies-the highly regarded and highly paid sure jobs	10 th April , 2021	Tusharika S. Banerjee	Mr. M K Seth, Chief General Manager, Advanced Level Telecommunication Training Centre
23	EXTC Journal Launch	30 th May, 2021	EXTC Journal Committee	EXTC Journal Committee
24	Value Added Course on Industrial Internet of Things	28 th June – 4 th July 2021	Prof. Ruchira Patole	Prof. Ruchira Patole

Industry Expert Lecture on Opportunities and careers in Power Electronics

Shri S.D.Naik is CEO of Ashida Electronics private limited. He had received Bachelor's Degree in Electrical Engineering from Somaiya College in the year 1968. He started Ashida Electronics Pvt. Ltd. Company along with his Brother in law Shri Manohar Kulkarni in year 1969. The company's first 'year turnover in the year 1970 was just Rs.62500/- which has now grown to Rs.170 Crores with around 500 workforce and 4 working units in Thane Wagale estate area. Mr. Naik has received many appreciations and awards including best I.T. unit award for Maharashtra, felicitated by CM of Maharashtra. He was also honored with Thane Bhushan Award.

Department of Electronics Engineering, PCE, New Panvel organized Industrial Experts Lecture on, "Opportunities and careers in Power Electronics" where speaker explained about different opportunities available for Electronics engineer. He also discussed with students about startups and issues they may face while building an enterprise.

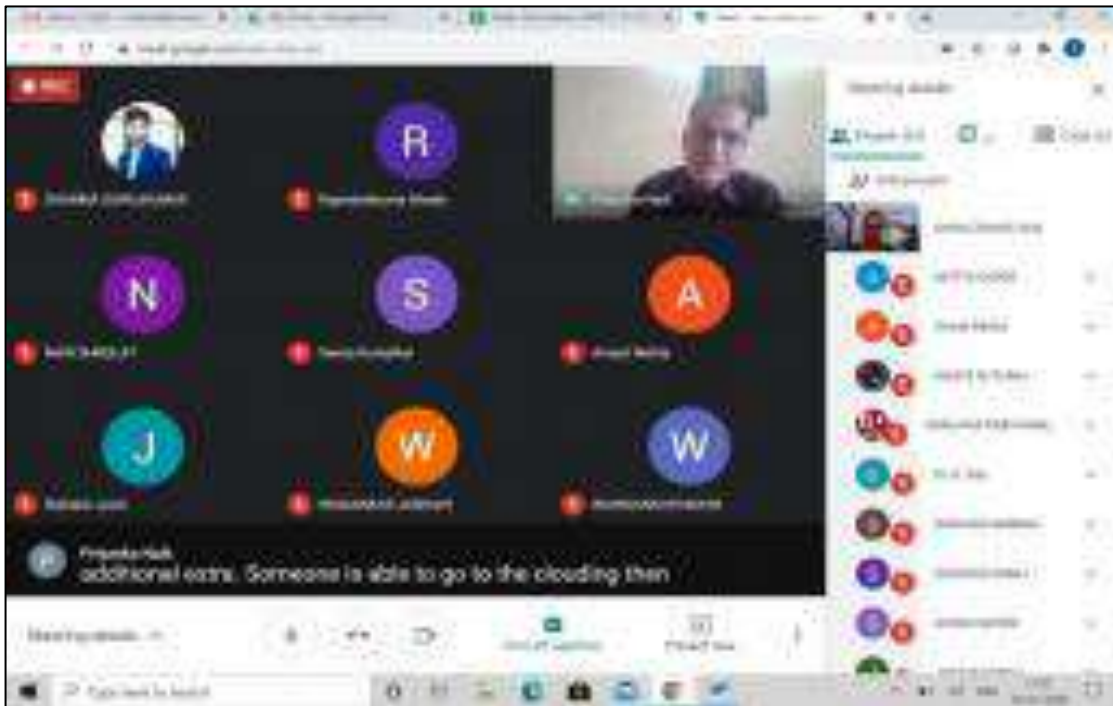

Mr. S. D. Naik interacting with students

Industry Expert lecture on Reliance JIO 4G Architecture

Department of Electronics and Telecommunication Engineering, PCE, New Panvel, organized Industry Experts Lecture on “4G Architecture” where speaker explained about actual architecture at Reliance Jio and connected students learn in textbooks and real world.

Reliance Jio Infocomm Limited, Jio, is Indian Telecommunication Company and subsidiary of the department of Jio Platforms, headquartered in Mumbai, Maharashtra, India. It operates a national LTE network with coverage across all 22 telecom circles. It does not offer 2G or 3G service, and instead uses only voice over LTE to provide voice service on its 4G network. During the session the speaker explained deep knowledge about overview of mobile communication i.e. 2G, 3G and actual 4G Architecture at reliance JIO, which covered concepts of LTE, then Volte, session was full of enthusiasm and valuable knowledge.

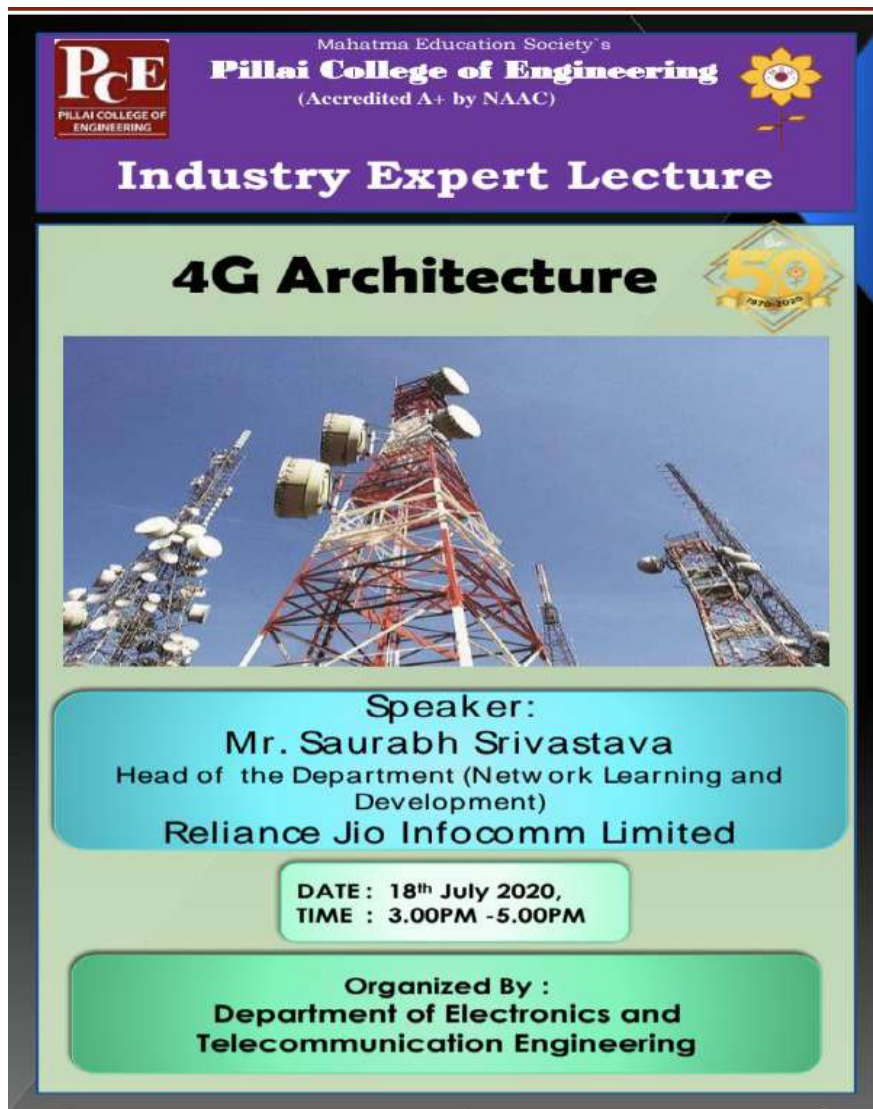

The poster features a purple header with the PCE logo and college name. Below this, the title 'Industry Expert Lecture' is written in white. The main title '4G Architecture' is in large black font, accompanied by a '50th Anniversary' badge. A central image shows several telecommunication towers against a blue sky. Below the image, a light blue box contains the speaker's name and affiliation. A white box with a green border provides the date and time. At the bottom, a green box identifies the organizing department.

Mahatma Education Society's
Pillai College of Engineering
(Accredited A+ by NAAC)

Industry Expert Lecture

4G Architecture

Speaker:
Mr. Saurabh Srivastava
Head of the Department (Network Learning and Development)
Reliance Jio Infocomm Limited

DATE : 18th July 2020,
TIME : 3.00PM -5.00PM

Organized By :
Department of Electronics and Telecommunication Engineering

Seminar on Looking Forward to a Brighter Future

Speakers: Mr. Vinit Sonawane- Destination Manager for Canada, Mr. Manish Watkare Destination Manager for USA, Mr. Aashay Dubey- IELTS, GMAT, GRE expert, Prakhar Australia Counselor and Coordinator Mr. Neel Vora from IDP Education Limited.

Department of Electronics and Telecommunication Engineering, PCE, New Panvel, organized Seminar under Departmental Placement Activity on “Looking forward to a Brighter Future”, focus of the Seminar was on Overseas Education to enlighten the students about the prospects of higher studies abroad and to debunk the myths surrounding it.

Points discussed for students seeking overseas education opportunities in recognized institutions in Australia, USA, Canada, UK & New Zealand. More about the, application submission, scholarship guidance, offer acceptance, visa assistance, tuition fee payment, pre departure orientation and on-shore support.

The agenda of the seminar was as follows:

- 1) Importance of Higher Education
- 2) Current scenario of the Education system in India (Knowledge- Skill gap)
- 3) Myths about the Overseas Education.
- 4) Do's and Dont's to Study Abroad.
- 5) Study and Placement prospects in Canada, USA, UK, Australia, New Zealand, Germany etc.
- 6) Documentation, Application, Visa process and Financials required to Study Abroad.
- 7) How To Crack Important Exams such as IELTS, TOEFL, GMAT, GRE etc.

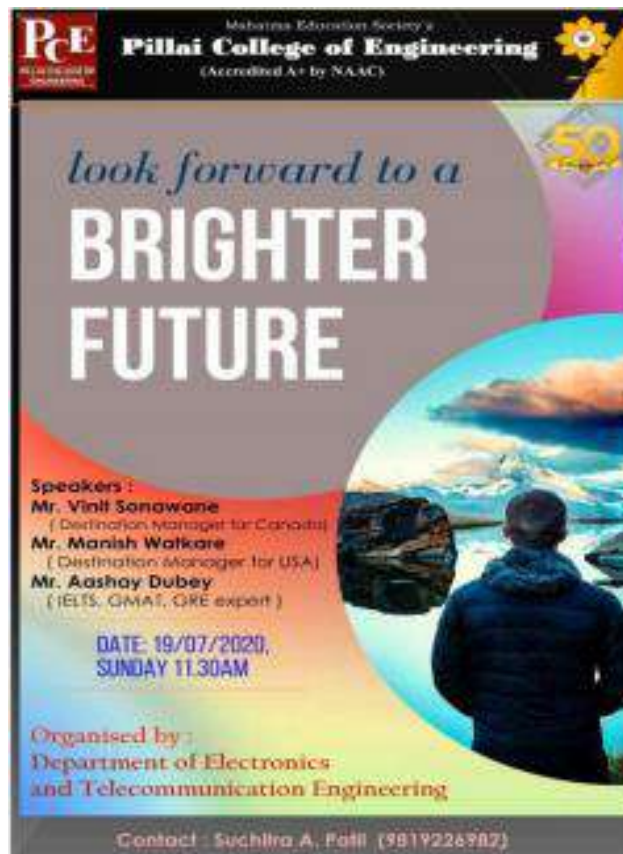

Industry Expert Lecture on “Future in Cloud Services”

The expert lecture on “Future in cloud services” was held on 25th July 2020 by Mr. Saurabh Kulkarni, Technical Architect, TIETOEVRY INDIA. Mr. Saurabh explained the essential requirements for the cloud services, how it works and what are the skills & demand in cloud services. Mr. Saurabh also explained different companies who are involved in cloud services and their requirements to be fulfilled by students for getting placed. He also emphasized on different skills in demand, some like coding skills, database skills, AI and ML where students can explore for their placement in the IT field. Dr. Avinash Vaidya, Head of the Department, Electronics and Telecommunication Engineering further guided students on different sectors where students can target and also different courses which the students can look upon to build a career in the field of cloud services.



Mahatma Education Society's
Pillai College of Engineering
 (NAAC Accredited A+ Institute)

PCE
 PILLAI COLLEGE OF
 ENGINEERING

Department of Electronics and Telecommunication Engineering
 — Industry Expert lecture —

Future in Cloud Services

Top Skills

- Microsoft Azure
- Office 365
- Solution Architecture

Certifications

- The Open Group Certified: TOGAF® Standard, Version 9.2
- Enterprise Design Thinking Practitioner
- Hoxhunt Phishing Detection

Mr. Saurabh Kulkarni
 TECHNICAL ARCHITECT • TIETOEVRY INDIA

Eminent Speaker

About Speaker

- ❖ 16 Years in IT Industry
- ❖ Formerly worked with Accenture, Patni, Capgemini
- ❖ Azure & Microsoft 365 Technical Architect

[Winner of numerous corporate awards]

 Saturday, 25th July, 11:00 AM

RFID and Its Applications

Speaker was an alumnus of IIT Bombay. He has completed his B.Tech. in Chemical Engineering, from IITB. He has a vast industry experience of more than 20 Years and have handled several positions and job responsibilities, like, team member, Product Manager, Project leader, Director and consultant in Indian, US and Hong Cong based companies. He is the Managing Director of RF Tags and Services, since 2010. Mr. Ketan Kolge, Managing Director of "RF Tags and Services" has delivered a talk on "RFID and Its Application", for Electronics and Electronics and Telecommunication Engineering students of Pillai Engineering College. In this talk, some insights related to RFID technology and its various applications were discussed. About 75 students of electronics and electronics and telecommunication engineering along with 10 faculties have attended this talk, followed by an interactive question answer session. The speaker has agreed for collaborative work and sharing of resources. He has also agreed to deliver another talk on Implementation of RFID for a specific application, in near future.



PCE Mahatma Education Society's
Pillai College of Engineering
(Accredited A+ by NAAC)

Industry Expert Lecture On RFID & It's Applications

RFID Solution

- Automobile
- Manufacturing
- Retail
- Education
- Healthcare
- Facility & Service

Speaker:
Mr. Ketan Kolge
MD
RFID Tags & Services

Scheduled Date
Aug 1, 2020
@ 11:30am

Organized By :
Department of Electronics &
Telecommunication Engineering

For more details Contact: Dr. Shishir Jagtap (8097810351)

Advance Network Threats and Cyber Security

Speaker for the event was Mr. Shubham Jangid, Assistant Manager, Commedia Solutions. Department of Electronics and Telecommunication Engineering, PCE, New Panvel, organized Industry Experts Lecture on “Advance Network threats and cyber security” where speaker explained about the various hacks, how to secure our network. Final year students were the focused audiences of this talk from both departments. The event was successful and interactive where students asked a number of questions and the speaker could clear all doubts. It was a really long, quality interaction session where doubts regarding various theoretical aspects which students learn were put up to the eminent speaker.



Mahatma Education Society's
PILLAI COLLEGE OF ENGINEERING
(ACCREDITED A+ BY NAAC)

Industry Expert Lecture

**Advance Network Threats and
Cyber Security**

Speaker
Mr. Shubham Jangid
Assistant Manager
Commedia Solutions

AUGUST 1, 2020
2:30 P.M. - 3:30 P.M.

Organized by
Department of Electronics and Telecommunication Engineering

Industry Expert Lecture on Database and Analytics Scope in IT World



Mahatma Education Society's
Pillai College of Engineering
 Department of Electronics and
 Telecommunication Engineering

-----Industry Expert Lecture-----

Database and Analytics Scope in IT World



Mr. Saurabh Deo
 Associate Manager,
 Level - 8
 ACCENTURE, INDIA

About Speaker

- Exp : 12 yrs in SAP BI Consultant
- Second in training for Oracle 9i in 2008
- ACE Award - Winner Q3 - 2017
- ACE Award - Winner Q1 - 2008
- Pinnacle Award H2 2020 - A - team
- Current Role : SAP BW/BI Project Delivery Manager , Lead
- Cleared Cognizant Certified Professional (CCP) exam for SAP BW7.0 Practitioner

 **12 SEP 2020 SATURDAY 11AM**

Department of Electronics and Telecommunication Engineering, PCE, New Panvel, organized Industry Experts Lecture on “Database and Analytics Scope in IT” where the speaker explained what kinds of databases are available in the market and how they are handled in the real world. He also explained what are different companies in the market and the features and functions provided by them. He motivated students and explained to students how they can be successful in this non electronics field and achieve success.

Future Educational opportunities and Job Opportunities in Machine Learning and Artificial Intelligence

Department of Electronics and Telecommunication Engineering, PCE, New Panvel, organized Industry Experts Lecture on “Future Educational opportunities and Job Opportunities in Machine Learning and Artificial Intelligence” where the speaker explained in three sections

1. What is Artificial Intelligence and Machine Learning
 - Types of Machine Learning Techniques
 - Types of Deep Learning Techniques

2. Higher Educational Opportunities

- Degrees and Disciplines
- How to Prepare

3. Job opportunities

- Specific Opportunities
- How to Prepare



Electronics and Telecommunication Engineering Journal Launch

PCE Electronics and Telecommunication Engineering Department Journal's launch was held on 20th August at 05:00 PM. Program started with launching the two issues Dec 2019 and June 2020. Students working under the Journal Team extended their gratitude towards respected Professors Prof. J. B. Bhosale and Prof. Suchitra A. Patil (Associate editors of Journal team), HOD of Electronics and Telecommunication Dr. Avinash Vaidya and Principal Dr. Sandeep Joshi, who has given them wonderful opportunities. Committee members thanked and commemorated the final year students' who had submitted their work to the committee. In addition, the event also was to welcome the new committee members of the year 2020-2021.



Mahatma Education Society's
Pillai College of Engineering
Department of Electronics and Telecommunication
Engineering

**INVITING YOU
TO
JOURNAL LAUNCH**
OF ELECTRONICS AND TELECOMMUNICATION DEPT.
2020

Felicitations of 2019-20
committee

Welcoming 2020-21
committee

Certificate distributions for
all Authors and members

**Join Us
On
20th August
At
5.00 PM**

Webinar Series on “RF ASICs Design Using CST”

Mr. Kartik Goyal, Application Engineer at “Jyoti Electronics”, has delivered webinars on "RF ASICs Design Using CST", for Electronics and Electronics and Telecommunication Engineering faculties of Pillai Engineering College. In this talk, various antenna design constraints suitable for various applications were discussed. The design of dipole antenna, microstrip antenna, multiple input multiple output antenna systems, horn antenna and RFID tag antenna design were discussed. About 10 faculties of electronics and electronics and telecommunication engineering have attended this talk, followed by an interactive question answer session. The speaker has agreed for collaborative work and sharing of resources. He has also agreed to deliver another talk on EMI-EMC measurement, in near future. Indeed it was successful event, thanks to HOD Sir, Principal Sir, and management for their timely advice and co-operation for organizing this event.



The poster features a black header with the PCE logo on the left and a sunflower logo on the right. The text in the header reads: "Mahatma Education Society's Pillai College of Engineering (Accredited A+ by NAAC)". Below the header, the title "Webinar Series On RF ASICs Design Using CST" is displayed in large, bold letters. A list of topics follows, including CST Basics, Design of Planar & Non Planar Antennas, Design of Advanced Antennas, EMI-EMC Measurements, Design of RF Components, and Lab Sessions on Fiber Optics. Two callout boxes provide speaker and date information. The speaker box is red and contains the name Mr. Kartik Goyal, his title as Application Engineer at Jyoti Electronics. The date box is yellow and states the scheduled dates as 27th & 30th Oct. 2020. The organizer information is located below these boxes, and a contact number is provided at the bottom of the poster.

PCE
PILLAI COLLEGE OF
ENGINEERING

Mahatma Education Society's
Pillai College of Engineering
(Accredited A+ by NAAC)

Webinar Series On
RF ASICs Design Using CST

- CST Basics
- Design of Planar & Non Planar Antennas
- Design of Advanced Antennas
- EMI-EMC Measurements
- Design of RF Components
- Lab Sessions on Fiber Optics

Speaker:
Mr. Kartik Goyal
Application Engineer
Jyoti Electronics

Scheduled Date
27th & 30th Oct. 2020

Organized By :
Department of Electronics &
Telecommunication Engineering

For more details Contact: Dr. Shishir Jagtap (8097810351)

Networking Fundamentals

The event was attended by Head of Electronics Engineering Department, Dr. R H Khade and Head of Electronics and Telecommunication Engineering Department, Dr. Avinash Vaidya. Faculty members and students of second year attended the webinar enthusiastically. Sachin explained the students the very basics of networking which has created an interest amongst students to pursue higher studies and career in this field. It was a successful event where the speaker interacted with students nicely and cleared their doubts.



**Mahatma Education Society's
Pillai College of Engineering
(Accredited "A+" grade by NAAC)**

**Department of Electronics and
Telecommunicaton Engineering**

**Talk
on
Networking
Fundamentals**

**Name of the speaker
Mr. Sachin Gupta.
Student Of PCE
BE EXTC BATCH 2020**

SCHEDULED FOR SE STUDENTS

**Nov 08,2020
Time 3:00PM - 4:30 PM**

Contact
Prof. Sonali Kathare 8879304899
Prof. Harsha Ghadge 9664736770

Impulse Based Time Domain Technique for Hidden Target Detection

This talk gave an insight on application of ultra-wide band (UWB) time-domain sub-surface radars, equipped with special signal processing techniques, to realize non-invasive testing of hidden targets. Basic design principle of impulse based UWB antenna with time domain operation and 3D wave tomography was discussed thoroughly during this talk. Also, some methods to increase operational characteristics of impulse antenna with radiating capability was discussed.



MAHATMA EDUCATION SOCIETY'S
PILLAI COLLEGE OF ENGINEERING

**Impulse Based Time Domain Technique
for
Hidden Target Detection**

Details

Speaker: <i>Dr. Shivraj Rathod</i> ● Assistant Manager ● Defence R & D ● Kalyani Center for Technology & Innovation	Electronics & EXTC	Scheduled on 13 th Feb, 2021 Saturday 3:30 pm onwards
--	---------------------------------------	--

GATE 2022 Training

Department of Electronics Engineering and Electronics and Telecommunication Engineering, PCE, New Panvel, has organised a Short Term Training Programme for third year students on GATE 2022 Syllabus. This program is designed to train students for the upcoming GATE test. This programme contains all the subjects for ECE and EE branch. The subject was taught by the specific subject experts from departments. This programme teaches students the basics of each subject and covers up the tricks to solve difficult problems within specific time limits.

Introduction to Networking and Cyber Security

Mr. Tanmay Pradhan, who is our Alumnus (2018) and Technical Executive at, Softcell technologies, Mumbai, discussed the importance, scenario and concept of networking and cyber security. He shared his experience in the field as well as discussed some important case studies related to the topic. He gave a detailed idea about this area like what are different courses students should do various certification courses as well as mentioned the industries.



PCE Pillai College of Engineering
Mahatma Education Society's
Pillai College of Engineering
Department of Electronics and Computer Science

Introduction to Networking and Cyber Security

for FE, SE, TE students from ETRX and EXTC Department

scan to join

With the world becoming more connected every single day, security is becoming increasingly more important. In an age where we manage more and more of our lives digitally, it means that anyone—in any career—should have basic knowledge of cybersecurity as well as keeping security up to par.

Mr. Tanmay Pradhan
Technical Executive, Softcell Technologies
(Electronics Department Alumni)

Date: 27th March 2021
Time: 10 AM to 11 AM

SQL for data science

Department of Electronics and Telecommunication Engineering, PCE, New Panvel, has organised an Add On course on “SQL for DATA SCIENCE”. This course was designed looking into facts that Now-a-days Data Science, Big Data and Database Management Industry is booming. And students should be ready to fit themselves into such Industry and make their future. This course covers all the basic information about SQL programming for Data Science. This course was for beginners who are new to the field of Data Science and wish to learn all about SQL programming. This course covered all the SQL instructions used by Microsoft SQL server.



Pillai College of Engineering
Accredited 'A+' by NAAC
Department of
Electronics and Telecommunication Engineering

SQL for Data Science

Course Duration: 16 + 20 hrs
Dates: 11, 18, 25 April 2021 & 2nd May 2021
Session Timings: 11-1 pm and 2-4 pm

COURSE CONTENT

- Introduction to Databases, SQL and Microsoft SQL
- Getting Started, Selecting and Retrieving Data with SQL
- Filtering, String and Calculating Data with SQL
- Subqueries and joins in SQL
- Modifying and Analyzing Data with SQL

COURSE FEATURES

- Certified Instructor
- Interactive Sessions
- Industry Expert Session
- Online Tutorials
- Practice Assignments
- Quizzes

About Instructor
Prof. Abhishek A. Khedkar
Asst. Professor - Electronics and Telecommunication Engineering - PCE
Contact Details
Mob: 9082603682
Email: abhis@pce.ac.in

Add-On Course Fees:
Rs. 1500/- For outside participants
Rs. 1000/- For MES participants

CLICK HERE TO REGISTER NOW

Networking and Communication

Department of Electronics and Telecommunication Engineering, PCE, New Panvel, organized Industry Experts Lecture on “ Networking & Communication ” where speaker explained in three sections .

1) Networking:

- Common Network Components
- Network Classification
- Protocol Reference models
- Distance Vector Routing
- Link State Routing 1

2) Cellular

- Evolution to 5G
- LTE
- WLAN
- Thread

3) Skills and Career Opportunities in the networking field.



Mahatma Education Society's
Pillai College of Engineering
Department of Electronics and Telecommunication Engineering

INDUSTRY EXPERT TALK ON
Networking and Communication

Scan to Join

Speaker



Home Protocol Engineer at
Apple USA

Mr. Utsav Katira
--Masters In Electrical Engg. from University of Buffalo
--Masters In Software Engg.

Every sector requires networking in some or the other way. In the business sector, networking is applicable from manufacturing to business processing. As organizations and institutions invest in domains like technology, cloud, computing, big data, etc they all depend on a workforce with networking skills to make the most of this technology. Today the supply of networking workforce does not match with the demand, due to which in the future these professionals will discover opportunities for the growing economy.

**On 17th April 2021
At 11.00 AM.**

Contact- Prof. Sonali Kathare - 8879304899
Prof. Jayshree Bhosale - 9920939098

Career Path in Software Development - The Unsaid Things

Department of Electronics and Telecommunication Engineering, PCE, New Panvel, organized Industry Experts Lecture on “ Career Path in Software development - The unsaid things” where the speaker explained

- 1) Software Development
 - SDLC Phases
 - SDLC Models
- 2) Jobs in Market
 - General Team Structure
 - Web application Architecture
- 3) Where to begin
 - The Building Blocks
 - The X-Factor
 - What do you do know
 - The dark side

Development in Latest Digital technologies-the highly regarded and highly paid sure jobs

Department of Electronics and Telecommunication Engineering, PCE, New Panvel, organized Industry Experts Lecture on “Development in Latest Digital technologies-the highly regarded and highly paid sure jobs” where speaker explained about the Basics of Mobile communication, tower, hand over and cellular aspects along with the detailed specification of existing backups and optical fiber lines in terms of contributions from private as well as government sectors. Industry and the role of Engineers for the same in current scenario and future perspectives, various aspects like health, environment, food crisis and need of large no. of Engineers were explained.

Electronics and Telecommunication Engineering Journal Launch 2020-2021

PCE Electronics and Telecommunication Engineering Department Journal's launch held on 30th May at 11:30 AM. Program started with launching the two issues Dec 2020 and May 2021. Students working under Journal Team extended their gratitude (Ms. Divya and Ashith) towards respected Professors Prof. J. B. Bhosale and Prof. Suchitra A. Patil (Associate editors of Journal team), HOD of Electronics and Telecommunication Dr. Avinash Vaidya and Principal Dr. Sandeep Joshi, who have given them wonderful opportunity. Committee members thanked and commemorated the final year students' who have submitted their work to the committee. In addition, event also was to welcome the new committee members of the year 2021-2022.



Value Added Course on Industrial Internet of Things

Industrial Internet of things (IIoT) deals with the application of sensors, controllers and actuators to develop efficient manufacturing techniques for the advancement of industrial processes. It leverages the potential of smart machines to use the data captured by them for analytics and decision making. IIoT also known as Industry 4.0 makes machines capable of decision making by analysing the captured data in real time. IIoT also emphasizes on communicating the data to proper channels to drive accurate and faster business decisions.

With an aim to acquaint students with the working of Industrial Internet of Things and its advancements, this value-added course was conducted from 28th June 2021 to 4th July 2021. It was a 35 Hours course. After the completion of all the topics, the students were assigned a capstone project, which they had to complete for acquiring the course completion certificate.

The topics covered during the course were Getting Started with the Internet of Things (IoT), IoT Device Configuration and Communication, Predictive Analytics and data storage for IoT Solutions, IoT Security and Architecture Design, Business Orientation & Intelligence for IoT Solutions, Industry 4.0, Fundamentals of AR Development with Vuforia Engine in Unity, Game Development and esports and Digital Twins technology driven by IoT.



Mahatma Education Society's
Pillai College of Engineering
(NAAC Accredited A+, 5 Star IIC)

Department of Electronics and Telecommunication Engineering
Presents Course on

INDUSTRIAL INTERNET OF THINGS

EXTENDED REALITY INTEGRATION & ASIC DEVELOPMENT

Course Content:

- Getting Started with the Internet of Things (IoT)
- IoT Device Configuration and Communication
- Predictive Analytics and data storage for IoT Solutions
- IoT Security and Architecture Design
- Business Orientation & Intelligence
- Industry 4.0
- Capstone project

What's new this year?

Fundamentals of AR Development with Vuforia Engine in Unity
Game development and esports
Digital twins technology driven by IoT

With Emphasis on:	Duration of course: 30 Hrs
· Creation of IoT XR Applications with Unity	Date: 28 th June to 4 th July 2021
· Deploy actions using AWS IoT Greengrass	Fees:
· Robotic Process Automation using UiPath	Rs. 1500/- (For MES Students)
· Connecting to cloud using Azure Sphere	Rs. 2000/- (for outside MES Students)
· Development of ASIC SOC and FPGA solutions	Limited Entries
· Prototyping boards, sensors, intelligent logistics	

Contact: Prof. Ruchira Patole (9920321421)
Cisco Certified Instructor
IBM Watson IoT Expert

Department of Applied Sciences, Mathematics and Humanities

Sr. No.	Name of the Activity	Date	Organiser	Speaker/s
1	Three-day online conference on “Proficiency Improvement on Polymer Processing and Advanced Characterization Techniques”	1 st -3 rd July, 2020	Dr. Biswajit Panda	Prof. Ashok Misra, Dr Priam Pillai, Dr. V. K. Gupta, Dr. Prakash Trivedi, Prof Anup K Ghosh, Dr Babu Padmanabhan, Prof Jayesh Bellare, Prof. Arup Bhattacharyya Dr. Sumanda Bandopadhyay
2	Unlock Engineering 1.0	23 rd -31 st July, 2020	Prof. Ranjita Gaonkar and Prof. Yogesh Kene	Prof. Ameya N, Prof. Binsu B, Dr. Sundeep Deulkar, Prof. Shivapradeep M, Prof. Florence S, Prof. Ishmeet Singh, Prof. Yogesh K, Prof. Archana I, Prof. Kamini C, Prof. Ruchira P, Prof. Krishnendu N, Prof. Dhiraj A, Prof. Madhura V
3	Webinar on “How to Improve Concentration During Online Learning Through Simple Yoga Activities” in association with PCE-NSS	25 th July, 2020	Prof. Sonali Nikam, Prof. Ravindra Nikam	Mr. Ram Palat Yadav (Retd. Lieutenant, Indian Navy), Rajya Karyakarini Member of Patanjali Yog Samiti, Mumbai prant and Jilla Prabhari, PYS, Raigad District
4	Online Faculty Orientation Programme of Engineering Mathematics III and Engineering Mathematics IV (for ‘C’ Scheme)	29 th July, 2020	All faculty members of Engineering Mathematics	Dr. Sachin S Wani, PCE, New Panvel Dr. Pritam Gujrathi, RAIT, Nerul Dr. Mansha Kotwani, Thadomal Sahani, Bandra Ms. Usha Bag, LRTCE, Mira Bhayandar
5	Webinar on “What, Why and How of Engineering”	1 st -15 th August, 2020	Prof. Suhas L, Prof. Deepti Nair, Prof. Prakash B, Prof. Rubina S	Dr. Arun Pillai
6	Unlock Engineering 2.0	10 th -21 st August, 2020	Prof. Krishnamohan Menon, Prof. Anup Vanage	Prof. Binsu B, Prof. Amey N, Prof. Shivapradeep, Prof. Florence S, Prof. Ishmeet S, Prof. Ruchira P, Dr. Sundeep D, Prof. Yogesh K, Prof. Archana I, Prof. Kamini C, Prof. Dinesh T, Prof. Deepti Nair, Prof. Madhura V
7	Workshop on “Applications of GeoGebra” in association with Spoken Tutorial-IITB	7 th -12 th September, 2020	Prof. Kuberal S, Prof. Mahesh Kudre	Dr. Sachin S Wani, Dr. Anshu Murarka, Prof. Archana Ingole, Prof. Sneha Jondhale, Dr. Kuberal S, Prof. Suvarna H, Prof. Maheshkumar K

8	Webinar on “Sustainable Manufacturing”	8 th September, 2020	Dr. Surabhi Singh, Prof. Deepti Nair	Dr. Rakesh Kumar, Director, CSIR-NEERI
9	Course on “Teaching Online: Interactive and Inclusive Aspects”	31 st October- 6 th December, 2020	Prof. Krishnamohan M, Prof. Lily P	Dr. Arun Pillai, Dr. Sundeep Deulkar, Dr. Malavika Sharma, Dr. Manju Pillai
10	Webinar on “Admission Guidance for Engineering Aspirants”	2 nd -3 rd December, 2020	Prof. Deepti Nair	Dr. Arun S Pillai, Dr. Avinash R Vaidya, Prof. Ameet Mehta
11	Pre- Placement Talk	20 th & 22 nd February, 2021	Prof. Manisha S	Dr. Prashanth S Lokhande
12	IELTS Prep Course	20 th February- 21 st March, 2021	Prof. Krishnamohan Menon	Prof. Rakhee Nair & Prof. Darshana P
13	Webinar on “Zero Gravity-Human Space Mission”, in association with PCE-IIC	28 th February, 2021	Dr. Sundeep Deulkar	Dr. Arun DI, Scientist, Vikram Sarabhai Space Centre, ISRO
14	Webinar on “A Model Based Framework For Intelligent System Automation-An Overview”, in association with IWSA	6 th March, 2021	Prof. Deepti Nair	Prof. Sachin C Patwardhan, Professor, Department of Chemical Engineering, IIT Bombay
15	Workshop on “Youth Health and Mind Management”	22 nd -25 th March, 2021	Prof. Anup Vanage	Mrs. Maheshwari Narayanan and team of Art of Living teachers
16	Workshop on “Business Plan for Start-ups”, in association with PCE-IIC	3 rd April, 2021	Dr. Richa S Agrawal, Dr. Avinash Vaidya	Prof. Leena Potdar
17	“Online Intra- College Debate Competition”, in association with PCE Nature Club, CEPSE, ICPE	5 th & 12 th June, 2021	Dr. B Panda, Dr. Sundeep D, Prof. Deepti Nair	Padmashri Dr. Swaminathan Sivram, Honorable Professor IISER, Pune & Calcutta and Padmashri Dr. Sharad Kale, Head of Technology Transfer and Collaboration at BARC
18	National Level Mathematics Quiz	19 th June, 2021	Prof. Kamini C, Prof. Archana I	-
19	SANMATI 2021	28 th & 29 th June 2021	Prof. Anup Vanage	Dr. Surabhi Singh, Dr. Malavika Sharma, Prof. Darshana P and Dr. Sundeep Deulkar

Three Day Online Conference on “Proficiency Improvement on Polymer Processing and Advanced Characterization Techniques”

In continuation with the Golden Jubilee celebrations of Mahatma Education Society, Centre of Excellence in Polymer Science & Engineering (CEPSE), Pillai College of Engineering (PCE) in association with Polymer Processing Academy (PPA) organised a three day online conference on “Proficiency Improvement on Polymer Processing and Advanced Characterization Techniques” from 1st July to 3rd July, 2020. Renowned and eminent speakers from Industries and Academics were invited for this conference. The conference drew 226 participants from various industries and educational institutes from across India and abroad.

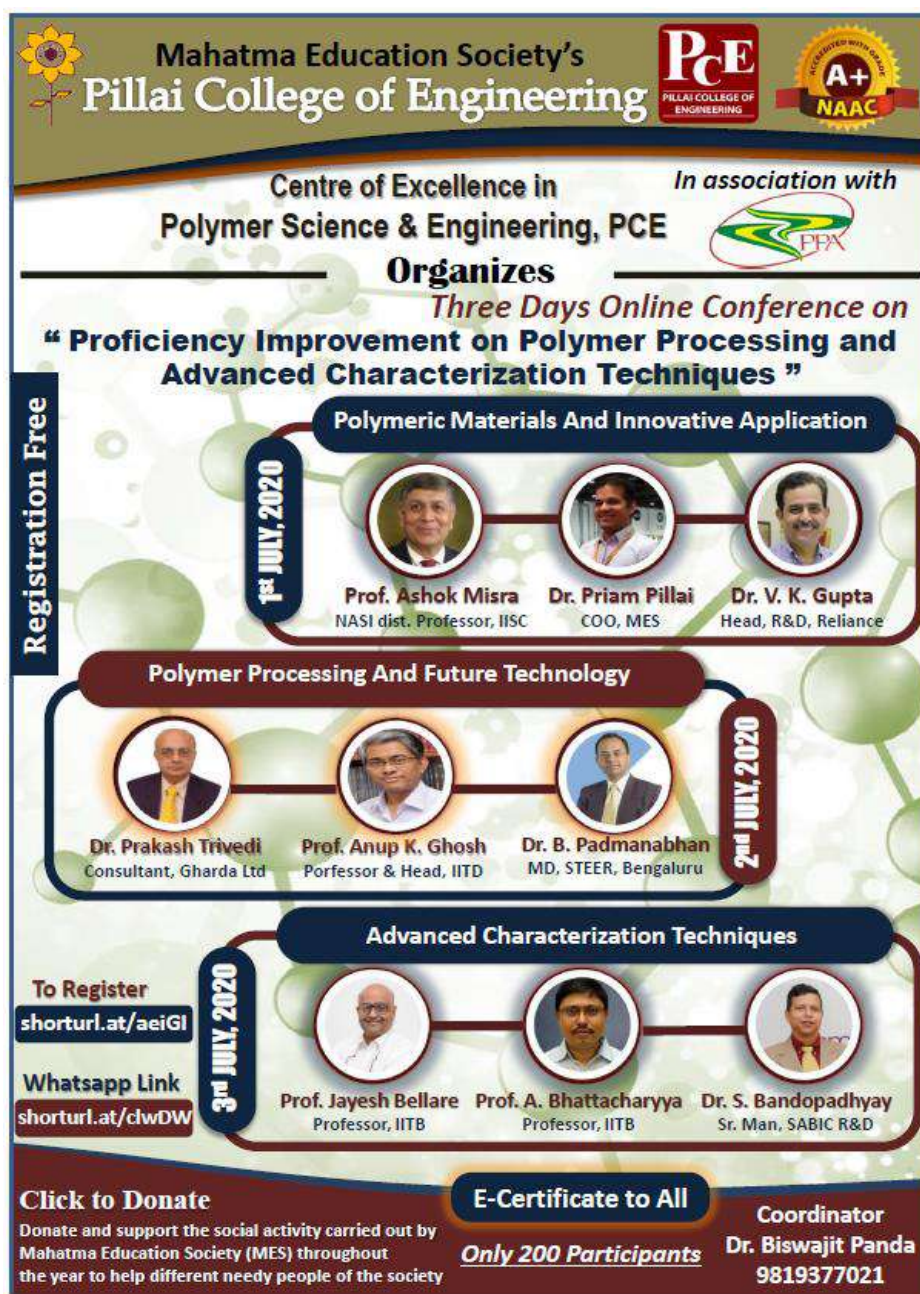

Mahatma Education Society's Pillai College of Engineering

Centre of Excellence in Polymer Science & Engineering, PCE

In association with **PPA**

Organizes

Three Days Online Conference on “Proficiency Improvement on Polymer Processing and Advanced Characterization Techniques”

Registration Free

1st JULY, 2020

Polymeric Materials And Innovative Application

Prof. Ashok Misra (NASI dist. Professor, IISC) | Dr. Priam Pillai (COO, MES) | Dr. V. K. Gupta (Head, R&D, Reliance)

2nd JULY, 2020

Polymer Processing And Future Technology

Dr. Prakash Trivedi (Consultant, Gharda Ltd) | Prof. Anup K. Ghosh (Professor & Head, IITD) | Dr. B. Padmanabhan (MD, STEER, Bengaluru)

3rd JULY, 2020

Advanced Characterization Techniques

Prof. Jayesh Bellare (Professor, IITB) | Prof. A. Bhattacharyya (Professor, IITB) | Dr. S. Bandopadhyay (Sr. Man, SABIC R&D)

To Register
shorturl.at/aeiGI

Whatsapp Link
shorturl.at/clwDW

Click to Donate
 Donate and support the social activity carried out by Mahatma Education Society (MES) throughout the year to help different needy people of the society

E-Certificate to All
Only 200 Participants

Coordinator
 Dr. Biswajit Panda
 9819377021

Unlock Engineering 1.0 and 2.0

A 2-weeks online activity camp for the students who completed their board exams (Class X and Class XII - Science) and also for diploma students. It was one-of-a-kind fun activity camp which exposed the students to various branches of engineering. There were two batches for this camp- one from 23rd to 31st July, 2020 and the other one from 10th to 21st, August 2020. Unlock Engineering 1.0 had 29 students enrolled, while Unlock Engineering 2.0 had 22 students.

Unlock Engineering 1.0



UNLOCK ENGINEERING

EXCLUSIVELY FOR CLASS 10 AND CLASS 12 STUDENTS

Two-weeks online activity camp will include:

1. Product Design
2. Photography
3. Personal Website Design
4. Writing Blogs
5. Electronics - An Introduction
6. Sensors in day-to-day life
7. Internet of Things (IoT)
8. Cyber Security

And a lot more fun activities.

Date: 23rd July - 31st July 2020 | Time: 3:30 PM - 5:30 PM

Registration Fee: Rs. 500/-

Link for registration: <https://forms.gle/KiRcaf4sE3PX2fCd9>
 Link for payment: <https://pages.razorpay.com/unlockengineering>

Event Coordinators
 Prof. Ranjita Gaonkar - 98219 42327
 Prof. Yogesh Kene 83691 29689

Unlock Engineering 2.0

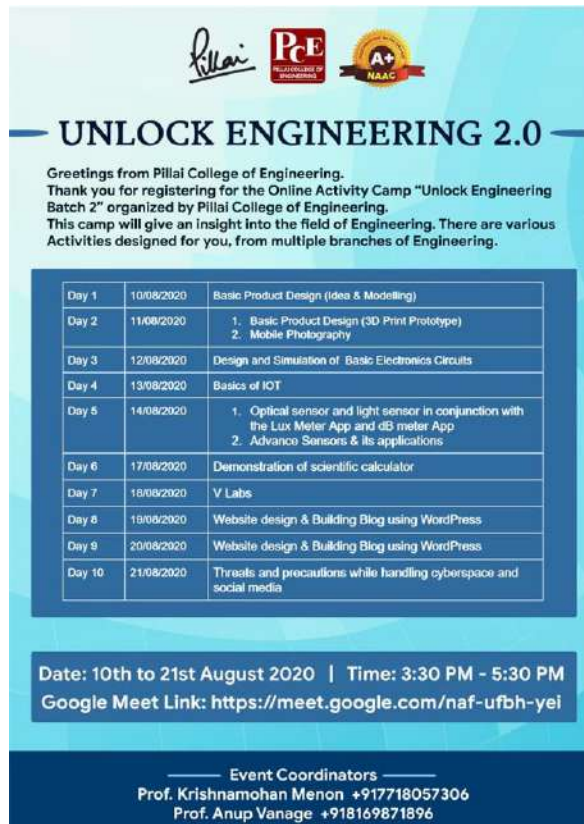

UNLOCK ENGINEERING 2.0

Greetings from Pillai College of Engineering.
 Thank you for registering for the Online Activity Camp "Unlock Engineering Batch 2" organized by Pillai College of Engineering.
 This camp will give an insight into the field of Engineering. There are various activities designed for you, from multiple branches of Engineering.

Day 1	10/08/2020	Basic Product Design (Idea & Modelling)
Day 2	11/08/2020	1. Basic Product Design (3D Print Prototype) 2. Mobile Photography
Day 3	12/08/2020	Design and Simulation of Basic Electronics Circuits
Day 4	13/08/2020	Basics of IOT
Day 5	14/08/2020	1. Optical sensor and light sensor in conjunction with the Lux Meter App and dB meter App 2. Advance Sensors & its applications
Day 6	17/08/2020	Demonstration of scientific calculator
Day 7	18/08/2020	V Labs
Day 8	19/08/2020	Website design & Building Blog using WordPress
Day 9	20/08/2020	Website design & Building Blog using WordPress
Day 10	21/08/2020	Threats and precautions while handling cyberspace and social media

Date: 10th to 21st August 2020 | Time: 3:30 PM - 5:30 PM

Google Meet Link: <https://meet.google.com/naf-ufbh-yei>

Event Coordinators
 Prof. Krishnamohan Menon +917718057306
 Prof. Anup Vanage +918169871896

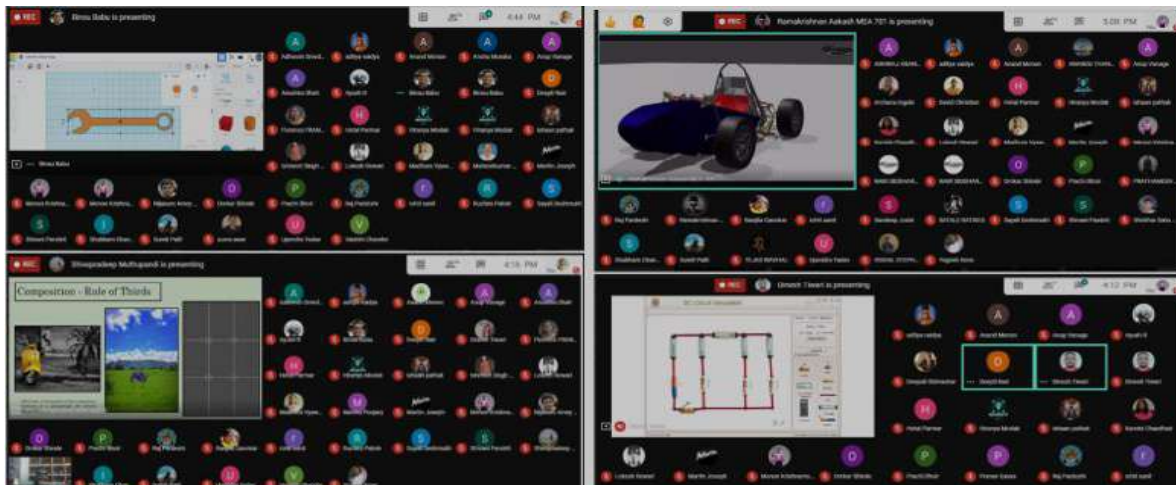

Webinar on “Why, What and How of Engineering”

A webinar on “Why, What and How of Engineering” was organised on 1st, 2nd, 8th and 15th August, 2020. This webinar was aimed to give an insight into the world of engineering for students who had just completed their high school education. The resource person was Dr. Arun S Pillai, HOD Applied Science, Mathematics and Humanities and First Year Coordinator.

In his presentation, Dr. Arun S Pillai emphasized that engineering is about showcasing problem solving skills and putting into practice the concepts learnt in Mathematics and Science. He also stressed on the fact that engineering involves continuous research to design and build prototypes - paving the path for innovation and technological advancements. Participants were introduced to the various branches of engineering, their scope of employment and higher education. He also summarized the admission procedure in Maharashtra. The session was made interactive through use of Mentimeter and ZOOM polls. The session concluded with a brief overview of the facilities offered by Pillai College of Engineering, followed by Q & A session. The webinar was attended by around 248 participants from all over Maharashtra.

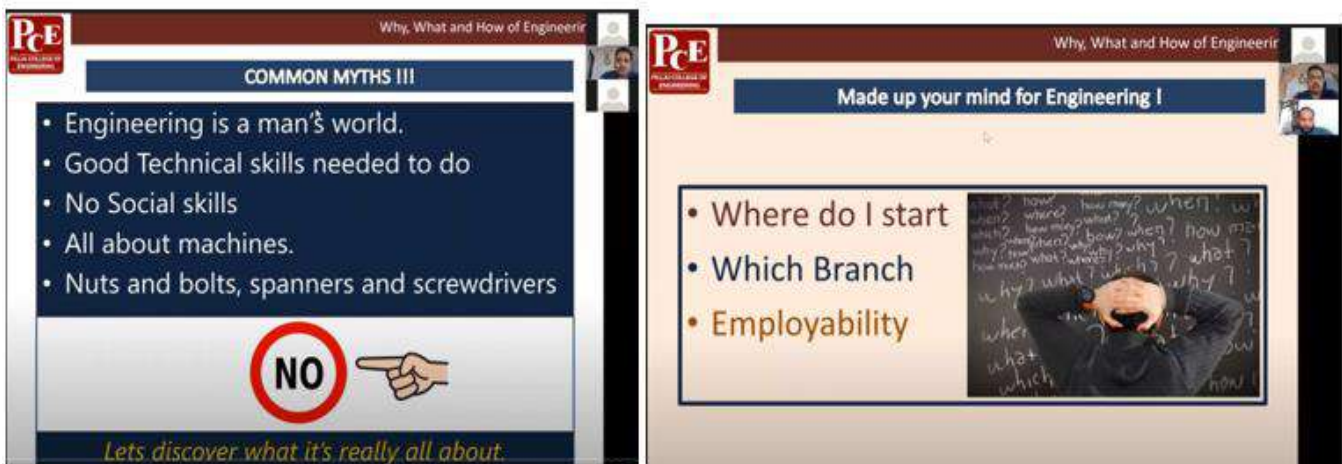

Talk by Dr. Arun S Pillai

Webinar on “Sustainable Manufacturing”

A national level webinar on the theme “Sustainable Manufacturing” was organised to celebrate International Literacy Day on 8th September, 2020. The resource person for the webinar was Dr Rakesh Kumar, Director, CSIR-NEERI.

Based on the premise that environment literacy reflects the sustainable development control on the use of natural resources, Dr. Rakesh Kumar in his presentation highlighted how to achieve sustainability in manufacturing. He emphasized the 6R methodology for sustainability enhancement in manufacturing processes which includes reduced use of materials, energy, water and other resources, reusing of products/components, recovery and recycling of materials/components, remanufacturing of products and redesigning of products to utilize recovered materials etc. Around 200 participants from academia and industry attended the webinar.



The poster features the PCE logo and Mahatma Education Society's Pillai College of Engineering A+ NAAC accreditation. It is organized by the Department of Applied Science, Mathematics & Humanities. The event is on International Literacy Day (8 September 2020). The central theme is 'Sustainable Manufacturing', with a call to 'Come Join us For A Talk on Sustainable Manufacturing'. A registration link is provided. The speaker is Dr. Rakesh Kumar, Director of CSIR-NEERI, whose photo is shown in a circular inset. A text box on the right describes his expertise in air pollution control, water treatment, and hazardous waste management, along with his awards and patents.

PCE Mahatma Education Society's
PILLAI COLLEGE OF ENGINEERING **A+ NAAC**

Department of Applied Science, Mathematics & Humanities
 Celebrates
 International Literacy Day (8 September 2020)

Come Join us
For A Talk on
Sustainable Manufacturing

REGISTRATION LINK

Date & Time
 8 Sep 2020 | 11 a.m. – 12.30 p.m.

Event Co-ordinators:
 Dr Surabhi, 91-9833633642, surabhi@mes.ac.in
 Prof. Deepti Nair, 91-9930766649, dnair@mes.ac.in

Dr Rakesh Kumar
 Director, CSIR-NEERI

Dr Kumar has significant contribution in the field of Air Pollution Control and Management, Water and Wastewater Treatment, Hazardous & Municipal Waste Management, Environmental Impact Assessment and Audit, Modelling, Health and Climate Change. Recipient of Commonwealth Commission Award, UK and "Environmental Leadership Award" by US Asia Environmental Partnership and US-AID, he has 12 patents on pollution control devices.

Certificate course on “Teaching Online: Interactive and Inclusive Aspects”

A 4 week certificate course on “Teaching Online: Interactive and Inclusive Aspects”, was conducted from 31st October to 6th December, 2020. The coordinators were Prof. Krishnamohan Menon, Assistant Professor, Department of Mechanical Engineering, Prof. Lilly Pradhan, Assistant Professor, Department of Mathematics. Participants included faculty members of reputed institutions and students pursuing courses in education. There were 4 modules designed for this course:

Module 1: Virtual Education by Dr. Arun S Pillai, supported by Prof. Dinesh Tiwari

Module 2: Pedagogy by Dr. Sundeep Deulkar, supported by Prof. Krishnamohan M

Module 3: Reflective Strategies by Dr. Malavika Sharma, supported by Prof. Deepti Nair

Module 4: Assessment by Dr. Manju R Pillai, supported by Prof. Lilly Pradhan

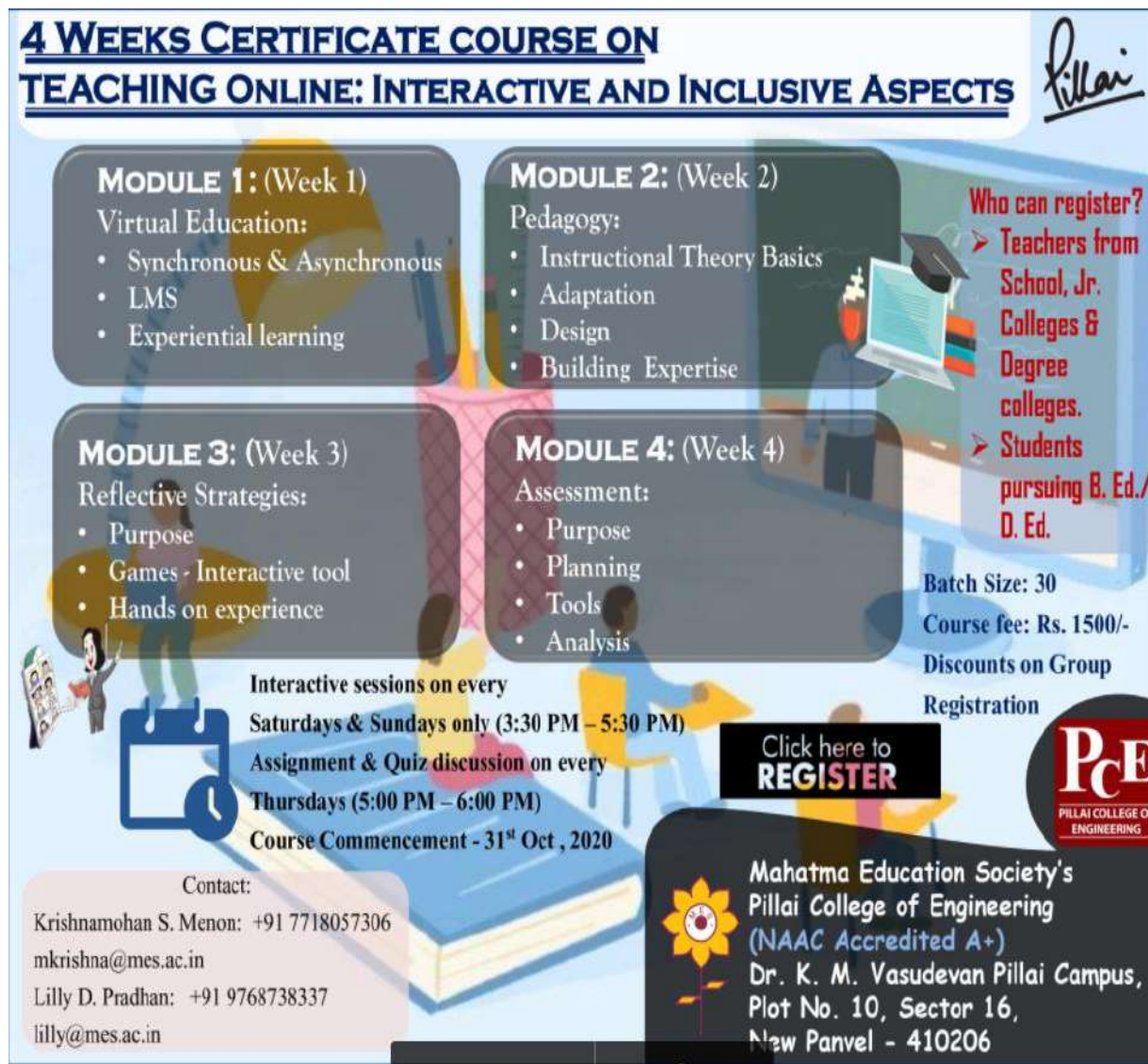

**4 WEEKS CERTIFICATE COURSE ON
TEACHING ONLINE: INTERACTIVE AND INCLUSIVE ASPECTS**

Pillai

MODULE 1: (Week 1)
Virtual Education:

- Synchronous & Asynchronous
- LMS
- Experiential learning

MODULE 2: (Week 2)
Pedagogy:

- Instructional Theory Basics
- Adaptation
- Design
- Building Expertise

MODULE 3: (Week 3)
Reflective Strategies:

- Purpose
- Games - Interactive tool
- Hands on experience

MODULE 4: (Week 4)
Assessment:

- Purpose
- Planning
- Tools
- Analysis

Who can register?

- Teachers from School, Jr. Colleges & Degree colleges.
- Students pursuing B. Ed./ D. Ed.

Batch Size: 30
Course fee: Rs. 1500/-
Discounts on Group Registration

Interactive sessions on every Saturdays & Sundays only (3:30 PM – 5:30 PM)
Assignment & Quiz discussion on every Thursdays (5:00 PM – 6:00 PM)
Course Commencement - 31st Oct, 2020

Click here to **REGISTER**

Contact:
Krishnamohan S. Menon: +91 7718057306
mkrishna@mes.ac.in
Lilly D. Pradhan: +91 9768738337
lilly@mes.ac.in

Mahatma Education Society's Pillai College of Engineering (NAAC Accredited A+)
Dr. K. M. Vasudevan Pillai Campus,
Plot No. 10, Sector 16,
New Panvel - 410206

PCE
PILLAI COLLEGE OF
ENGINEERING



Announcing the Top Three Performers of the course by Dr. Sandeep M. Joshi



"To Learn, Read; To Understand, Participate." - Debasish Mridha
The organising team of
4 Weeks Certificate course on
Teaching Online: Interactive and Inclusive Aspects (31 October- 06 December 2020)



would like to thank our

❖ *Resource People*





Dr. Arun Pillai Dr. Sundeep Doukhar Dr. Malavika Sharma Dr. Manju Pillai

for their outstanding contribution in sharing their expertise by introducing and providing resources that will support and enhance our classroom instructions, both, online and offline.

❖ *Participants of the course*

for their dedication, enthusiasm and positive spirit, which helped make our time together both productive and fun.

Testimonials

"This course gave us an opportunity to build ourselves on the virtual platform. Learn unique concepts necessary for the times today. The experts guided us not only during the teaching hours, but also off the hours to clarify our doubts on projects and assignments. This course was a boon to all of us."... Ms. Philomina Joachim G

"The best part was, all the sessions kept us focussed due to the tests taken in between, so minds were not diverted. Whatever I learnt, am surely going to implement them in my classes."...Ms. Meera Ranjith

"It was a great learning experience and brought our thinking and creativity to the next level. This platform gave us the knowledge and proved that humans have the ability to overcome and adopt to new challenges and situations. Looking forward to many more such workshops by Pillai College of Engineering, where we have lots of fruits to be taken home."... Ms. Iman Riyaz Bijie

Wish you all the best and looking forward to see you all again for the upcoming courses and events.

Organising Team

Prof. Krishnamohan Menon Prof. Lilly Pradhan Prof. Deepti Nair Prof. Dinesh Tiwari Prof. Anup Vanage

Post Event Flyer

Webinar on “Admission Guidance for Engineering Aspirants”

Multiple online sessions of a webinar on “Admission Guidance for Engineering Aspirants” was organised on 2nd and 3rd December, 2020, to guide students seeking admission to various courses of Engineering in Maharashtra State. The sessions were conducted by Dr. Avinash R. Vaidya, HoD Electronics and Telecommunication Engineering and Prof. Ameet M. Mehta, Assistant Professor, Electronics and Telecommunication Engineering department. Each session began with an introduction to “What is Engineering?” and the responsibilities it entails. The resource people gave an in-depth knowledge about the admission procedure, the various aspects to be considered when selecting a college and deciding the field of study. Furthermore, different scholarships that are available for the students were discussed during these sessions. An overview of Pillai College of Engineering, its courses and facilities were mentioned thereafter. Towards the end of each session, queries of participants were resolved by Dr Arun S Pillai- HOD Applied Science, Mathematics and Humanities and First Year Coordinator. In all, around 226 participants attended this webinar.



Talk by Dr. Avinash R. Vaidya



Talk by Prof. Ameet M. Mehta

IELTS Prep Course (Academic)

This online course was conducted from 20th February to 21st March, 2021 to help students attain a higher band score in IELTS exam, based on a needs analysis. The various modules discussed during the course aimed to develop their Listening, Reading, Reading and Writing (LSRW) skills. This was a 20-hour course conducted during the weekend's i.e. Saturday & Sunday (2 hrs per day) by Prof. Rakhee Nair, Assistant Professor, Department of Applied Science, Mathematics and Humanities, who is also a certified British Council IELTS Trainer and Prof. Darshana Pachkawade, Assistant Professor, Department of Applied Science, Mathematics and Humanities.



**Mahatma Education Society's
Pillai College of Engineering
Dr. K. M. Vasudevan Pillai Campus,
Plot No. 10, Sector 16,
New Panvel - 410206**

PCE **A+**
PILLAI COLLEGE OF
ENGINEERING NAAC

IELTS

IELTS Prep Course (Academic)
Kickstart your dreams!!!!!! Crack IELTS with High Band Score.....

Course Highlights:

- ❖ Advanced Curriculum Design
- ❖ Certified and trained instructor from British Council, India
- ❖ Interactive Online sessions
- ❖ Individual Attention
- ❖ On-the-spot Doubt solving
- ❖ One-on-one Feedback
- ❖ Performance Assessment / Mock Test
- ❖ Blended approach to learning via LMS
- ❖ Practice Assignment/ Material
- ❖ Online tutorials

Batch Size: 15 (Maximum) (Online)
Course commences from: 20 February, 2021

Instructors

Prof. Rakhee Nair
+91-9819795603
rnair@mes.ac.in

Prof. Darshana Pachkawade
+91-8097821875
dpachkawade@mes.ac.in

What you'll learn

- ❖ Develop high scoring responses related to IELTS test preparation
- ❖ Understand what the examiners are looking for
- ❖ Learn English Language Skills (LSRW)
- ❖ Gain confidence in sitting an English test

Course Duration:
20 hours
(2hrs per day
for 10 days)

Session timing:
3PM – 5PM
(Saturdays &
Sundays)

Course Fees:
Rs. 3000/- for
MES students
Rs. 5000/- for
outside
Participants

Contact: Prof. Krishnamohan S Menon
+91-7718057306
mkrishna@mes.ac.in

ENROLL NOW

Department of Applied Science, Mathematics & Humanities

The course commenced with IELTS Orientation Session for students. Practice tests and mock tests were conducted and consistent feedback was provided to the students for improvement. Interactive, task-based and exam-oriented sessions, conducted through online mode ensured thorough engagement, better comprehension of the concepts and prepared students to sit an IELTS Certification exam. Handy online practice and support materials were provided. Attendees also received certificates after completion of assignments and mock test.

A Pre- Placement Talk

An online pre- placement talk by Dr. Prashant S Lokhande, PCE Training & Placement Officer, was organized for the First Year Engineering students on 20th and 22nd February, 2021. The talk was aimed to enlighten students on the various aspects of placements, such as skills required and to be developed for better placement opportunities, expectations from the industries, different categories of placements and many more. Dr. Prashant S Lokhande made the session interesting and interactive by putting forth a few thoughtful questions for the students which were enthusiastically attempted by the participants. The talk was followed by question and answer session on both days. In total, 470 first year students attended this webinar.

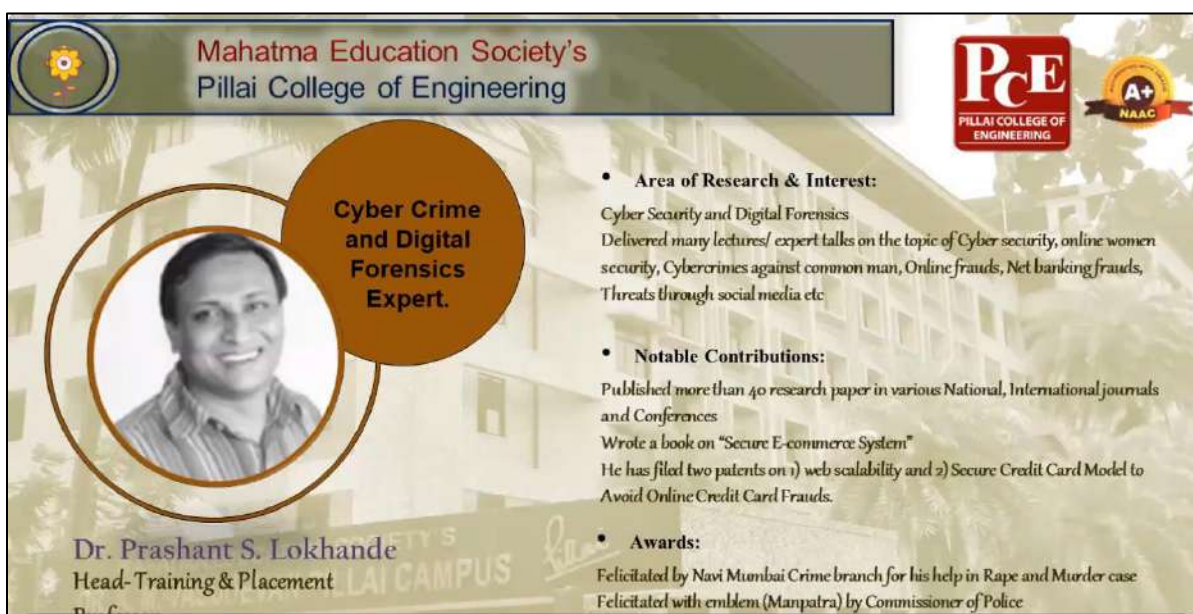

Mahatma Education Society's Pillai College of Engineering

Cyber Crime and Digital Forensics Expert.

Dr. Prashant S. Lokhande
Head- Training & Placement

- Area of Research & Interest:**
Cyber Security and Digital Forensics
Delivered many lectures/ expert talks on the topic of Cyber security, online women security, Cybercrimes against common man, Online frauds, Net banking frauds, Threats through social media etc
- Notable Contributions:**
Published more than 40 research paper in various National, International journals and Conferences
Wrote a book on "Secure E-commerce System"
He has filed two patents on 1) web scalability and 2) Secure Credit Card Model to Avoid Online Credit Card Frauds.
- Awards:**
Felicited by Navi Mumbai Crime branch for his help in Rape and Murder case
Felicited with emblem (Manpatra) by Commissioner of Police

Introduction of Dr. Prashant S Lokhande by Prof. Manisha Singh



PILLAI COLLEGE OF ENGINEERING
(FORMERLY PCE)

Training and Placement Cell
PCE

Dr. P. S. Lokhande, (TPO)

Formula for Placement: 3-Aces



Presentation slides

A webinar on “ZERO GRAVITY”

An experiment is a question which science poses to Nature and a measurement is the recording of Nature's answer-Max Planck

A webinar on ZERO GRAVITY by Dr. Arun DI, of Vikram Sarabhai Space Center was organised jointly by the Department of Applied Science, Mathematics and Humanities and IIC, to mark the celebration of National Science Day 2021 on Sunday, the 28th of February. An opening speech by Dr. Sandeep M. Joshi, Principal, emphasized the significance of 28th February: the day on which Dr. C. V. Raman discovered the Raman Effect.

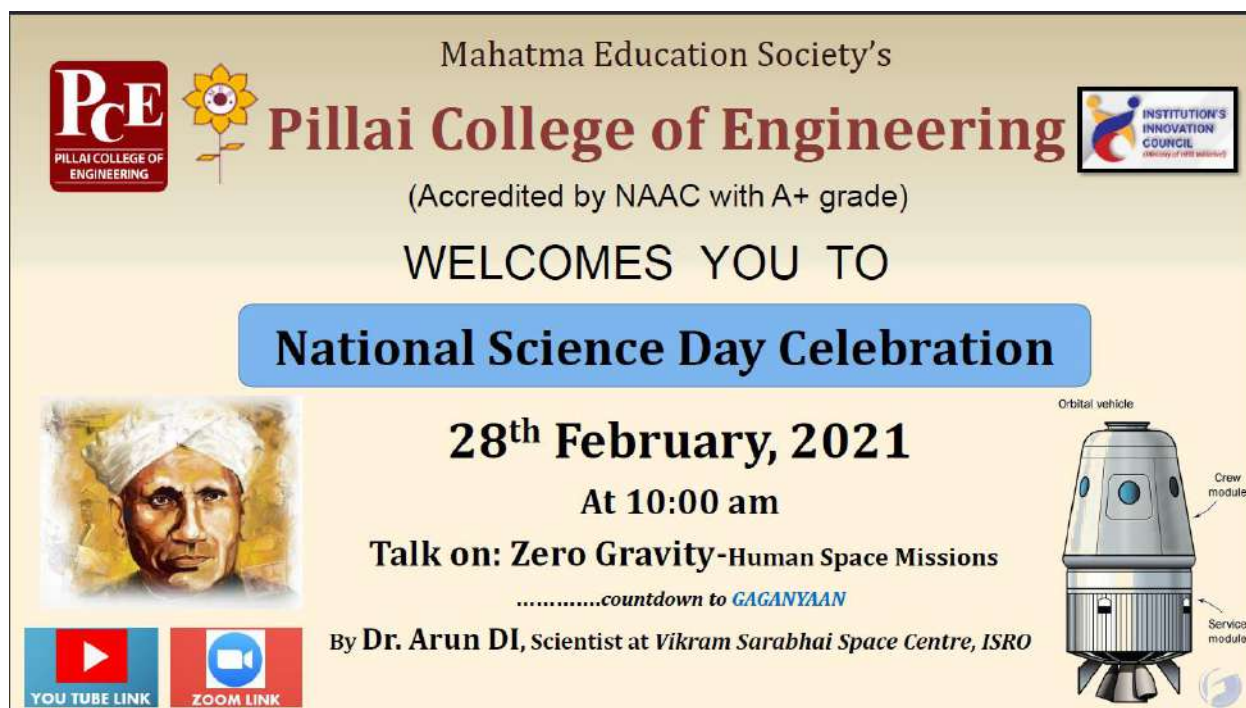

The poster is for the National Science Day Celebration on 28th February, 2021, at 10:00 am. It features the Pillai College of Engineering logo and the Mahatma Education Society's logo. The text includes: "Mahatma Education Society's Pillai College of Engineering (Accredited by NAAC with A+ grade) WELCOMES YOU TO National Science Day Celebration 28th February, 2021 At 10:00 am Talk on: Zero Gravity-Human Space Missionscountdown to GAGANYAAN By Dr. Arun DI, Scientist at Vikram Sarabhai Space Centre, ISRO". There is a portrait of Mahatma Gandhi on the left and a diagram of an orbital vehicle with labels for "Orbital vehicle", "Crew module", and "Service module" on the right. At the bottom left, there are icons for YouTube and Zoom links.

In his talk, Dr. Arun DI focused mainly on two objectives: the first was on the progress of mankind in the realm of global manned space flight scenario, and the second one on India's maiden attempt of a manned flight to Low Earth Orbit. Nearly 270 students and around 10 Professors from the First Year Engineering attended the lecture on Zoom Platform. The event was also live streamed on YouTube. The students were inspired by the talk as can be seen from the numerous questions that were posed for the speaker, and he was pleased by the enthusiasm shown by the students.

Here are a few interesting questions asked by the students:

1. How do we get images of our galaxy although we are a part of it?
2. What is the difference between Aerospace and Aeronautical Engineering?
3. Tell us something about SSLV launch vehicle.
4. What is the qualification criteria of an astronaut?

It was a rare coincidence that as the lecture was in progress, India's Polar Satellite Launch Vehicle PSLV-C51 successfully launched Amazonia-1 along with 18 other satellite payloads from Satish Dhawan Space Centre SHAR, Sriharikota.

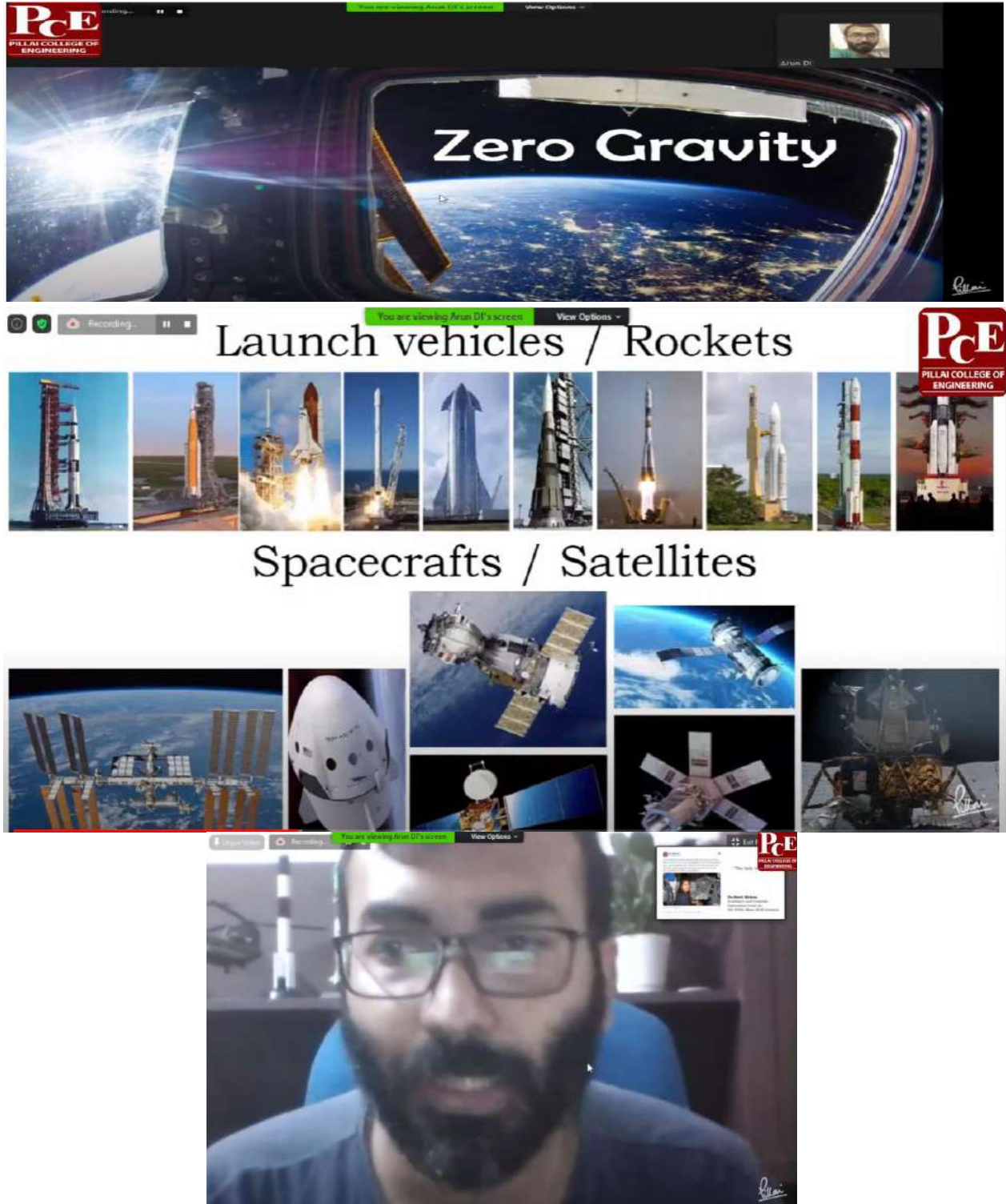

The screenshot shows a Zoom meeting interface. At the top, there's a video player titled "Zero Gravity" showing a view from space. Below it, a gallery titled "Launch vehicles / Rockets" contains ten images of various rockets. Underneath that is another gallery titled "Spacecrafts / Satellites" with seven images of different spacecraft and satellites. At the bottom, a video feed shows Dr. Arun DI, a man with a beard and glasses, speaking. The Zoom interface includes standard controls like "Recording...", "You are viewing Arun DI's screen", and "View Options".

Talk by Dr. Arun DI

A webinar on “A Model Based Framework for Intelligent System Automation: An Overview”

A webinar on “A Model Based Framework for Intelligent System Automation: An Overview” was organised on 6th March, 2021 by Indian Women Scientists’ Association, supported by BRNS- DAE in association with Department of Applied Science, Mathematics and Humanities, Pillai College of Engineering. This event was coordinated by Dr. Lalita Dhareshwar, President IWSA and Prof. Deepti Nair from PCE. The Keynote speaker was Prof. Sachin C Patwardhan, Professor, Department of Chemical Engineering, IITB. The talk started with a video on Minds + Machines- Meet the Digital Twin, which offered a captivating look into the digital twin technology. With significant advances in microprocessors and increased computing power, Prof. Sachin C Patwardhan emphasized on the fact that manufacturing and process plants are increasingly using on-line model based advanced control schemes for achieving economically optimal and safe operation. Such advanced control schemes involve use of mechanistic and data driven dynamic models which are used for online forecasting, fault and failure diagnosis, fault tolerant control and intelligent scheduling and planning of process operations. This talk gave an overview of model intelligent automation practiced in industry and future trends.

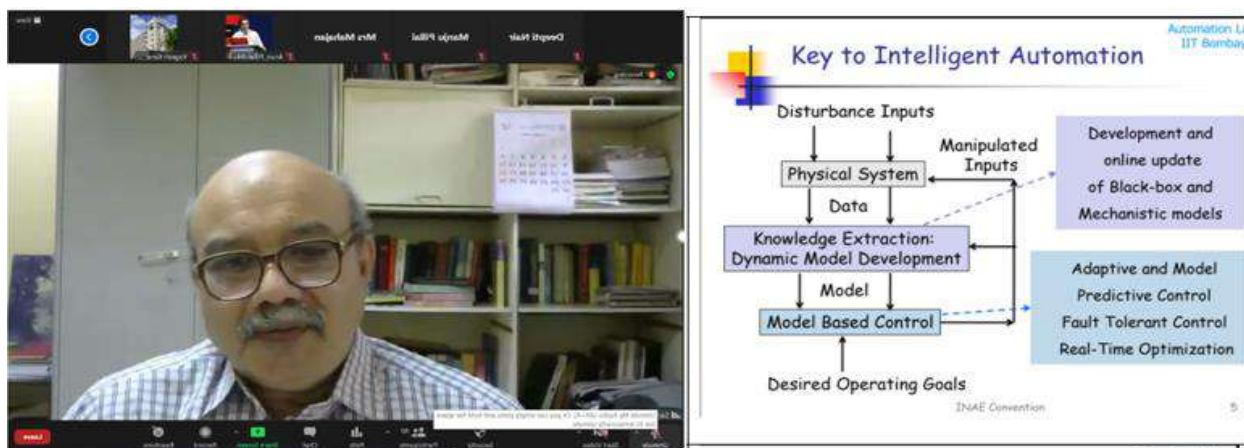

Talk by Dr. Sachin C Patwardhan



Event organising team

Workshop on ‘Business Plan for Start-up’

One-day online workshop was conducted on ‘Business Plan for Start-up’ on 3rd April, 2021. There were 70 registrations for the workshop from all over Maharashtra. The registration was free for all participants. The speaker for the event was Prof. Leena Potdar, Assistant Professor, Department of Applied Science, Mathematics and Humanities.

Entrepreneurship is making of a new business; it could be a startup or an old business that has changed so that it can be more successful. Being entrepreneur is more than just having an idea, passion and willingness to work hard. Being an entrepreneur requires business skills, like finding the right idea, the right opportunity, making a good business plan, getting support, attracting employees and investors to increase the size of the business over time. The workshop focused on introduction to entrepreneurship, related vocabulary, concepts and issues in English. It emphasized on writing a business plan. The structure of the workshop was as follows. The sessions included following modules.

1. Calculating Start-up costs, operating costs and sales projections
2. Creating a business plan.

The workshop was well received by the participants. They expressed need for the branch specific business plan writing. The workshop helped participants to create a business plan, highlighting important information about the present and the future of their business. It also taught to organize content, structure a brief business plan, designing a marketing plan and doing simple financial calculations.



MAHATMA EDUCATION SOCIETY
PILLAI COLLEGE OF ENGINEERING
DR. K.M VASUDEVAN PILLAI CAMPUS, PLOT NO: 10,
SECTOR 16, NEW PANVEL- 410206

One Day workshop on

Business Plan for Startup

03.04.2021, 11.A.M

Workshop Coordinator-
Prof. Leena Potdar

**FREE
REGISTRATION**

INSTITUTION'S
INNOVATION
COUNCIL
(Ministry of HRD initiative)

A+
NAAC

Department of Applied Sciences, Mathematics & Humanities

**For Registration
Contact: 9819298479**

Online Intra- College Debate Competition

An online Intra- College Debate Competition for First Year students was conducted on 5th June and 12th June, 2021 by PCE Nature Club and Centre of Excellence in Polymer Science and Engineering in association with Indian Centre for Plastics in Environment.

In his inaugural talk, Dr. Sandeep Joshi gave the message on environment day for 2021: Restoration of the Eco-system.

This talk was followed by Prof. Priam Pillai, COO of PCE emphasised that we usually tend to lose sight of important things in the grind of routine life and we should learn to be in harmony with nature. This talk was followed by the talk of the Guest of Honour Padma Shri Dr. Swaminathan Sivaram. An Indian polymer chemist, inventor, institution builder and a former director of the National Chemical Laboratory, Pune. He is known for his pioneering work on alkylation of tertiary alkyl halides with trialkylaluminum and olefin polymerization and holds the highest number of US patents by an Indian working outside the US. He is a fellow of several significant professional organizations. The Government of India awarded him the fourth highest civilian honour of the Padma Shri, in 2006, for his contributions to Indian science.

In his talk, Dr. Swaminathan spoke on the important topic of waste management. He emphasised that the NON COLLECTED WASTE amounts to about 3% of annual production yet 3% is a significant number if the consumption increases manifold. Also, there should be value addition and not value deterioration after recycling, hence without defining the grave no material can be termed as biodegradable. He emphasised that the solution is in our hands. Hence we should start using less plastic because technology alone cannot solve the plastic waste problem. We also need a behavioural mind set change for achieving sustainability. He finally quoted Mahatma Gandhi's epic quote: Be the change which you wish to see in the world.

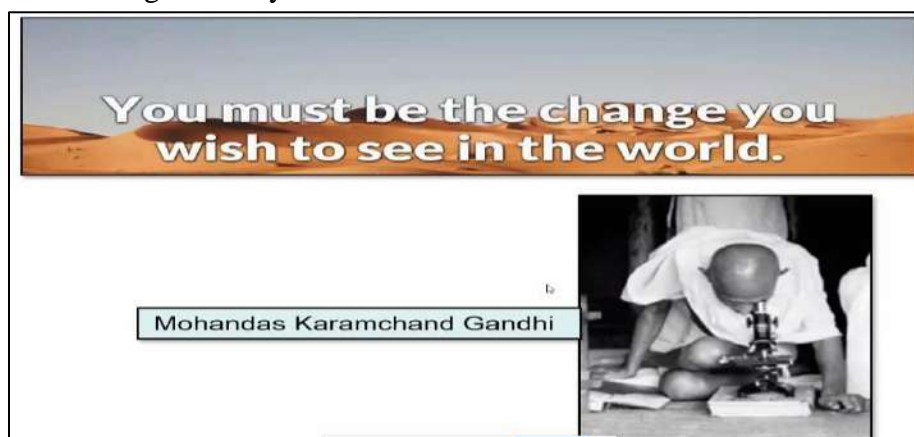

This was followed by the Debate for Round 1 for the topic: Conservation and Development cannot go hand in hand. In all 4 teams participated from A, B, C, and D divisions. The judges were: Dr. Brajesh Kr. Dubey, Professor of Civil Engineering, IIT- Kharagpur, Mr. Manish Khandelwal, Gen. Manager, Gail (India) Ltd., and Mr. Swapan Ray, Hon. Secretary, ICPE. The second round topic was: Plastic-a boon or bane for environment. The second part of the debate competition was continued on the 12th of June. The guest of honour was Padma Shri Dr. Sharad Kale. Dr. Sharad Kale explained that if one has to achieve a particular goal then one should be

MAD after achieving that goal. He cited the example of Louis Pasteur. He also emphasised that cleanliness is a form of seva and is next to godliness.

This speech was followed by a short speech from Mr. Swapan Ray of ICPE, wherein he spoke on intentional learning driven by growth mindset and curiosity. A healthy curiosity propels us to reflect and that failures are steps to gain knowledge. He also emphasised the importance of critical feedbacks. In this session, 4 teams participated from E, F, G and H divisions. The judges comprised of a homogeneous combination of representatives from Industry and academia: Dr. D.D. Kale, Ex. Professor from ICT, Mr Rajendra Gupta, GM at HPCL-Mittal Energy Limited (HMEL), and Mr Tushar Bandyopadhyay, Technical Director, ICPE. The final message from the judges was; The ground reality of Plastic recycling in India is completely different from other countries and that we should join hands and believe in our strengths. We should look at waste management from an investment point of view. We should stop littering and start recycling—starting from our homes because that’s one small step for man and a large leap for mankind towards a greener and pristine environment.

Chief Guest- 05 June 2021



Padma Shri Dr. Swaminathan Sivaram

Chief Guest- 12 June 2021

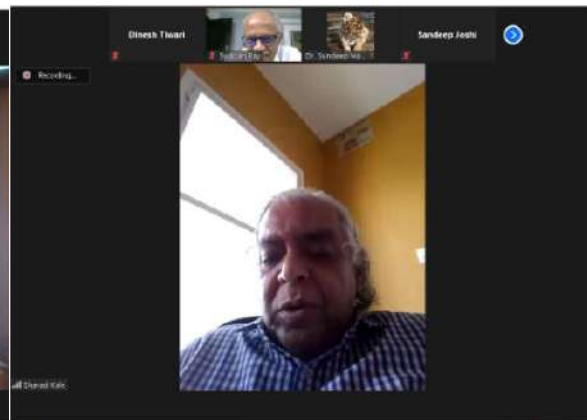

Padma Shri Dr. Sharad Kale

Winners of Rounds 1 & 2 conducted on 5 June 2021

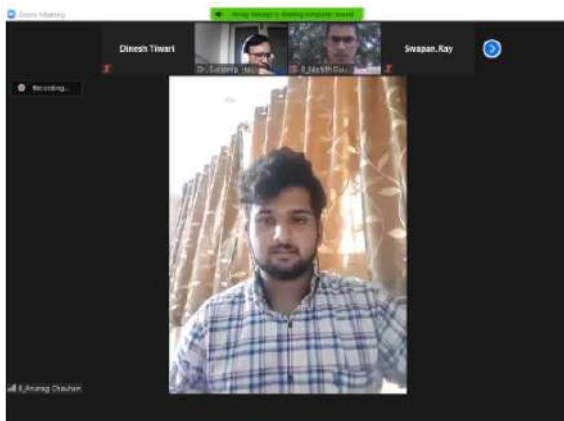

Chauhan Anurag Anil - F.E B Division

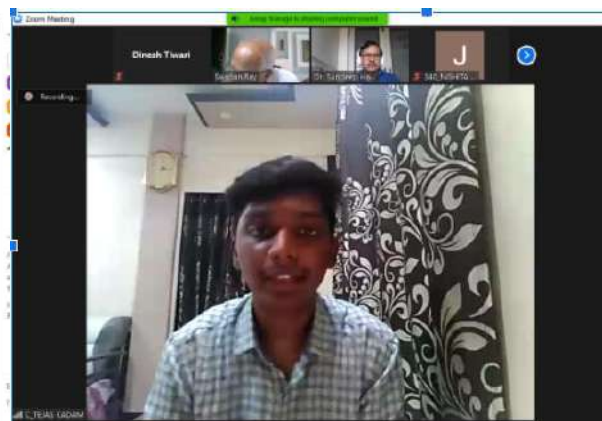

Tejas Kadam- F.E C Division

Winners of Rounds 1 & 2 conducted on 12 June 2021



Aarushe Reddy- F.E F Division

Taha Siddiqui- F.E G Division

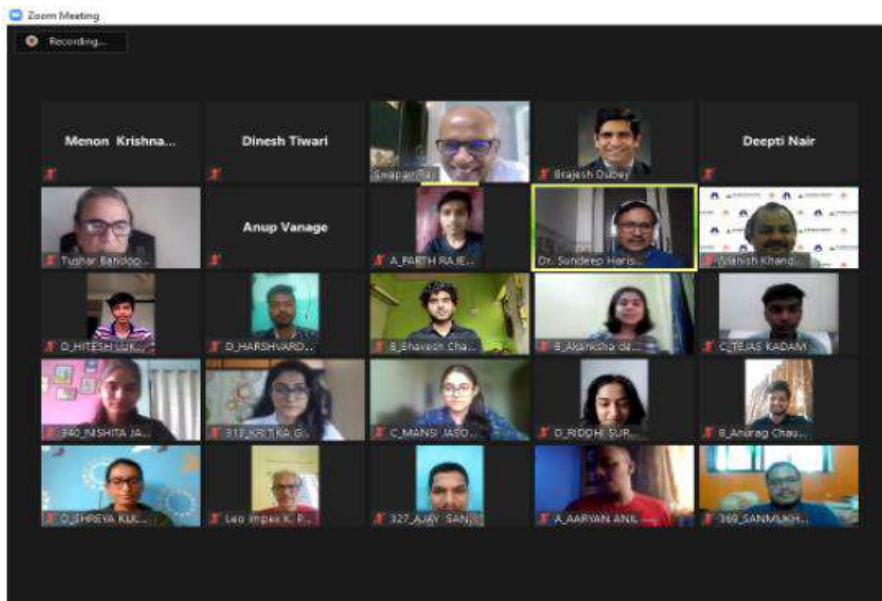

Judges, Participants and Organisers -05 June 2021

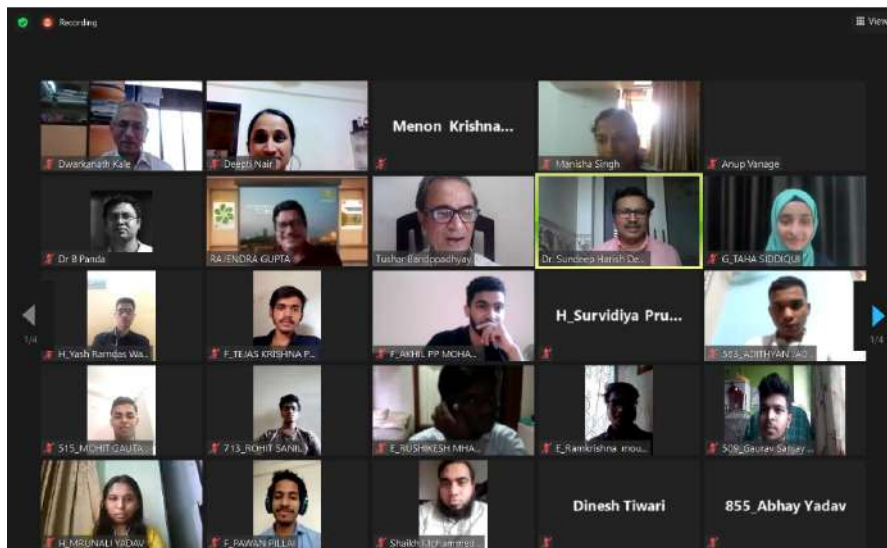

Judges, Participants and Organisers -12 June 2021

National Level Mathematics Quiz

A National Level Mathematics Quiz 2020-21 was organised on 19th June, 2021 for first year and second year science and engineering students. The purpose of this quiz was to develop an interest and to raise awareness among the students towards Mathematics, which will enable them to master the concepts of this subject during their higher studies. The quiz was based on the basics of Mathematics learned in higher secondary, first & second year of Science and Engineering Mathematics.

The quiz was organized in two parts. First part was the elimination round which was successfully conducted through online mode on 5th, March 2020. Elimination round had 50 MCQ questions, 2 marks each. A total of 341 students participated in this round, of which 189 students successfully completed round 1. Top 5% students, each from the first year and second year were selected for the second round of the quiz. Further, a second round of elimination was conducted to select the top 6 students, each from FE and SE for the final round. The final quiz was conducted on 19th June, 2021 in online mode through Google Meet. The quiz started with an opening remark delivered by Prof. Kamini Chaudhari, Assistant Professor, Department of Applied Science, Mathematics and Humanities followed by a welcome address by Dr. Sandeep Joshi, Principal, PCE, Dr. Arun S Pillai, HoD, Department of Applied Science, Mathematics and Humanities and Dr. Narendra R Dasare, President, EMTSI.



MAHATMA EDUCATION SOCIETY'S
PILLAI COLLEGE OF ENGINEERING
DR. K. M. VASUDEVAN PILLAI CAMPUS,
PLOT No: 10, SECTOR 16
NEW PANVEL - 410206







Department of Applied Science, Mathematics and Humanities,
in collaboration with
Engineering Mathematics Teachers Society, India (EMTSI)
organizing

**National Level
Mathematics Quiz
(2020-2021)**

Last date to register: March 05, 2021

Registration fees: Rs. 50/-



or

Click here to
REGISTER

Coordinators:
Kamini Chaudhari: +91 9969043463 email: kchaudhari@mes.ac.in
Archana Ingole: +91 9022866302 email: aingole@mes.ac.in



Prize:
First: Rs. 11,000/-
Second: Rs. 8,000/-
Third: Rs. 5,000/-

Who can participate in the Quiz?
All First Year and Second Year Undergraduate Science & Engineering Students .

Instructions!!

- 1) First round will be an elimination round conducted through online mode consisting of objective questions.
- 2) Click on the link below to view the topic:

First Year
Second Year
- 3) Selected top students will be informed for the final round.
- 4) Elimination round: 06th March, 2021
Final round: 20th March, 2021



The final round had three stages: Mastermind round, Bonus round and fastest finger round. Due to online mode, each round was conducted separately for the first and second year finalists. First year participants were named as DE MOIVRE, NEWTON, LEIBNITZ, TAYLOR, EULER, KARL GAUSS and second year participants as KARL PEARSON, LAPLACE, DE-MORGAN, CAUCHY, MILNE-THOMPSON, SPEARMAN. There was a special round for the audience also. All faculty members from the Department of Applied Mathematics actively involved themselves in the organization of this quiz, leading to a successful event. Dr. Snigdha Saxena and Dr. Sachin S Wani were the judges for this event. The Winners of the Quiz were awarded a cash prize and a certificate of appreciation. The remaining three participants from first and second year were also awarded with certificates of appreciation. The top 5 students from the audience round were also awarded with a cash prize. The students who had qualified for the elimination round were awarded with certificates of participation.

Winners of the National Level Mathematics:

Year	Name of the Group	Name of Student	Postion	Prize money
FE	Taylor	Anushka Nandkumar Mulik	First	5500
FE	De Movier's	Saurav Nirav Shah	Second	4000
FE	Euler's	Sairaj Sitaram Surve	Third	2500
SE	Milne Thomson	Khushi Krishna Veerothi	First	5500
SE	De Morgan	Rishabh Kothari	Second	4000
SE	Spearman	Asmita Amarsinh Pawar	Third	2500

Winners of the Audience round:

Year	Name of the Round	Name of student	Postion	Prize money
FE	Audience round	Mahima Verma	First	300
FE	Audience round	Harshvardhan Kedare	First	300
FE	Audience round	Kamlesh Yadav	Second	200
FE	Audience round	Suraj Yadav	Second	200
FE	Audience round	Samiktha Punathil	Second	200
FE	Fastest Finger Round (Audience winner)	Kamlesh Yadav		100
FE	Fastest Finger Round (Audience winner)	Viraj Rane		100

Training and Placement Cell

Introduction

The Training and Placement Cell is an integral part of the PCE Institution. The PCE management is fully invested in providing sound infrastructure and human resources to maintain the Training and Placement Cell and the resulting opportunities the cell provides to students of the College. The Placement Cell’s primary objective is to provide training and placements to college students. Various activities take place throughout the academic year in the college. Students are motivated to take the initiative to develop their attitude, soft skills and are given the opportunity to develop technical skills alongside analytical capabilities. The Training and Placement Cell aims to expose students to the nature of the corporate world therefore providing insight to their future professional careers.

About us

The Training and Placement Committee of Pillai College of Engineering handles campus placement of the graduating students of Engineering. TPC provides complete support to the visiting companies at every stage of placement process. Arrangements for Pre-Placement Talks, Written Tests, Interviews and Group Discussions are made as per the requirement of the companies. Pre-placement training is given based on their core subject followed by aptitude training. The objective of TPC is to facilitate the process of placement and ensure that each eligible student get opportunity in the industries. We organize technical events and motivational talks to provide a platform for the budding engineers. We conduct awareness programs for the students in the form of seminars and conferences in association with institution and corporate.

Sr. No.	Name of Activity	Date	Speakers
1	Session on Building an Innovation Product Fit for Market	14 th May, 2021	Mr.Shreekant Shiralkar
2	A webinar on “Induction Into The Indian Army - Officer Cadre” (For Men & Women)“	5 th September, 2020	Col. Arun Malhotra Capt. Supriya Patil Mrs. Ruby Talukdar
3	TCS FDP on Stress Management	19 th March, 2021	Ms. Hema Nair , TCS
4	Placement Opportunity For PCE Students During And After COVID19	23 rd July, 2020	Col. Arun Malhotra
5	Briefing about Placements	5 th August, 2020	Dr. Prashant Lokhande
6	Cracking Competitive exmas	8 th August, 2020	Shubham Maheshwari
7	A Webinar on “How to Prepare for The Interview”	12 th August, 2020	Dr. Prashant Lokhande

8	C.V. Building Webinar	8 th August, 2020	Dr. P.S. Lokhande
9	Mechanical and Automobile Placement Session	11 th August, 2020	Dr. Prashant Lokhande
10	“Gateway To Success Webinar” in association with Ekeeda	18 th August, 2020	Prof. Abhishek Barve, Prof. Mukesh Rai and Prof. Sameer Velankar
11	“Career In The Indian Armed Forces: Part 2”	5 th September, 2020	Col. Arun Malhotra, Capt. Supriya Patil and Mrs. Ruby Talukdar
12	Overseas Education – Suny Oswego	4 th December, 2020	Vision International – Overseas Education Consultant.
13	Overseas Education – Stevens Institute of Technology	5 th December, 2020	Vision International – Overseas Education Consultant.
14	“State Level Mega Job Fair 2020”	12 th December, 2020	Shri Deependra Singh Kushwaha- IAS, and Others
15	“Session on Building an Innovation/Product fit for Market”	14 th May, 2021	Shrikant Shiralkar, Seasoned management professional.

Pathway to Corporate

TPC-PCE organized the webinar under the guidance of our principal Dr. Sandeep Joshi and Head-Training & Placement Dr. Prashant S Lokhande. The purpose of this webinar was to familiarize the students with the upcoming online recruitment season and challenges in the process due to pandemic. Online training for the recruitment process was also discussed in the webinar. Mr. Vinay Raikar led off the webinar by stating that the adoption of a new methodology becomes of utmost importance. Due to the delayed recruitment season, the speaker urged students to use the time sensibly and prepare virtually. While speaking about facing the camera, he mentioned the influence of language, communication skills, and body language on the interviewer. He addressed the core fields of Mechanical and Civil Engineering and discussed its scope beyond core jobs. The speaker highlighted the importance of self-learning, time management, and adaptivity in the wake of this pandemic. The speaker threw light on the online training portal by "Campus Credential" and its features. Mr. Vinay Raikar recommended students to participate in various online coding competitions like TCS CodeVita and NQT. He emphasized skills, output, basics, and a positive attitude. Finally, yet importantly, Mr. Vinay Raikar answered the queries of students in a short interrogation session towards the end of the webinar. A large number of students were enlightened by the knowledge bestowed in the webinar making it an absolute success.



Placement Opportunity for PCE students during and after Covid-19

Under the headship of TPC-PCE, a webinar was conducted at Pillai College of Engineering. The speaker at the webinar was the Head-Training & Placement Dr. Prashant S Lokhande. The major motive of the session was to give information about the placement opportunities after the Pandemic situation. The speaker also intended to supervise students in training and preparation for the placement drive. Dr. Prashant S Lokhande started by discussing the grave condition of different sectors in the wake of Covid-19. The speaker asked students to imagine themselves in the chair of recruiters and prepare accordingly. Pointing to core field students, the speaker revealed the fact that IT companies like TCS and Infosys recruit core students too since they have demanding clients like Ashok Leyland and JCB. He mentioned the necessity for basic programming knowledge for core students in this day and age. Core jobs are tedious but beneficial in the long run. The speaker pressed the value of campus placement in a career and advised to keep the first job. Dr. Prashant S Lokhande emphatically told students to participate in online coding competitions like CodeVita TCS and InfyTQ. He cited the importance of participation and the formation of logic. In this time where placements are deeply affected, sir inspired students to work fearlessly and believe in themselves. In conclusion, queries regarding online training, placements, aptitude tests, and many more were resolved by Dr. Prashant S Lokhande. The webinar was a huge success. Lots of students attended this fruitful session.

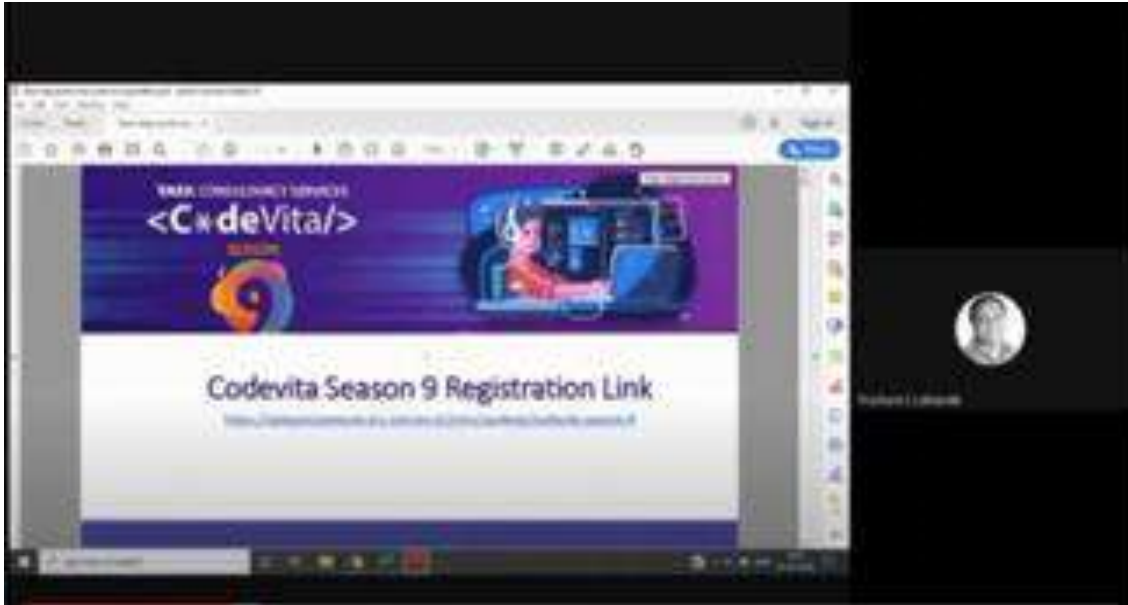

Carreer in the Indian Armed Forces: Part 1

In Commemoration of the Golden Jubilee year of Mahatma Education Society, Training and Placement Committee of Pillai College of Engineering, New Panvel conducted a motivational talk on “Career In The Indian Armed Forces Part:1” by Col. Arun Malhotra under the guidance of principal Dr. Sandeep Joshi and Head-Training & Placement Dr. Prashant Lokhande of Pillai College of Engineering. The objective of this event was to guide the students regarding career opportunities in the Indian Army, the challenges our soldiers face every day, and how they overcome every difficult situation. The webinar began with a patriotic song and a warm welcome of Col. Arun Malhotra by Dr. Sandeep Joshi followed by Dr. Daphne Pillai and a video presentation introducing the Indian Army where they showcase their remarkable achievements. Later, the speaker began to address the audience by sharing his personal life experience as an Indian Army Officer. Col. Arun Malhotra provided information about the recruitment process in the Indian Army, the eligibility criteria, and opportunities provided to enter the Indian Army. He addressed the audience by providing information on various modes of entry to the Indian Army - SSC for non-technical entry, Technical Entry, NCC Special Entry. He also provided insights on the hard facts about the Indian Army, further explaining the technical nature of work, its dimensions of support to other forces, and the need for technical qualification to be part of the fighting arms in the Indian Army. He even introduced the recently growing opportunities in Cyber Warfare command and recruitment, training of candidates, and salaries. Lastly, the feedback form was circulated amongst the audience who was highly motivated and inspired giving positive feedback on the webinar.



Speakers and Guest of the event

Briefing about Placements

The objective of this event was to make the students understand the process of recruitment of the selected companies to be well prepared for the same. The speaker Dr. Prashant S Lokhande commenced this webinar by introducing the expected companies to be visited, in the nearest time. How the companies are called, the average number of companies visiting the campus per year, the policies needed to be accepted by the institution, was stated. He shared, the research on selecting which companies to call first was directly proportional to the intake, the projects and honouring of the jobs. He then emphasized the criteria for recruitment. Stating that, he mentioned the placement pattern and its changes over the past years. Later, the criteria for the virtual hiring process in L&T were shared. The process was confined to the online assessment containing 3 steps along with Technical and HR interview. Then he explained the levels, including the packages they offered. He gave a walkthrough to the TCS portal and told why registration of TCS Code vita is important, its benefits and also shared what is TCS leader board and also what position our institution holds and how it can be improved. Infosys has a hackathon-based placement pattern which is competition based, named HackWithInfy. The speaker stated the preparation strategies for the same. Then, he presented a slide of all of our recruiters. The speaker then answered a couple of doubts raised by the students about the registration and placement process-related doubts and thus clearing all the doubts the webinar was concluded with a vote of thanks by the speaker.



Various slides of the Event

Cracking Competitive Exams

The objective of this event was to make the students understand the process of competitive exams and start the preparation accordingly. The speaker Shubham Maheshwari commenced this webinar with a short overview of the webinar’s agenda which was lined up as a comparison of M.B.A. MTech and M.S., Best MBA colleges, Doors to get into MBA, Campus Credential & MBA and the preparation for the examination. Comparing M.B.A. MTech and M.S., he explained what should be the factors for choosing it as a post-graduation course. The factors contained the reason, fees and competition in that respective field. Speaking about admissions, he shared the doors i.e., the examinations for getting admission in top M.B.A. colleges. The most preferred examination was CAT which is considered enough to secure a place in IIMs or IITs or any tier 1 colleges. The other examinations like XAT, CMAT, NMAT and IIFT were also explained. The time management and strategy for the respective exams were shared. Then he proceeded to how to prepare for the examinations and the role Campus Credential plays in the preparation. Then, the question-answer session was conducted which cleared all the doubts of the students, giving them a bright insight about what campus credential offers in the preparation of competitive exams for further studies.



Various slides of the event

C.V. Building Webinar

In accordance with the placement season, Training and Placement Committee of Pillai College of Engineering, New Panvel conducted a webinar on “C.V. building” by Dr. P.S. Lokhande on 8th August 2020. This webinar was organized by TPC-PCE under the guidance of principal Dr. Sandeep Joshi and Head-Training & Placement Dr. Prashant Lokhande of Pillai College of Engineering. The objective of this event was to guide the students regarding different ways of C.V. building. The webinar began by the speaker Dr. Prashant Lokhande where he started with the explanation on “What's in the name? - Curriculum Vitae, Resume, Biodata.” He demonstrated the framework of the C.V where to adjust the logo, the font size to be used, etc. He showed what all details should be mentioned in career objectives. He also mentioned how the Internship section plays an important role and in attracting the H.R. in the selection of an individual. He then displayed the do's and don'ts while building a proper C.V in detail. At the last he took a few minutes to answer all the questions of the students in the session and cleared their doubts. Last but not the least, the event was a grand success with a very large number of enthusiastic students to join the session and thus the webinar ended by the speaker Dr. P.S. Lokhande where he wished them the best for their future endeavours.

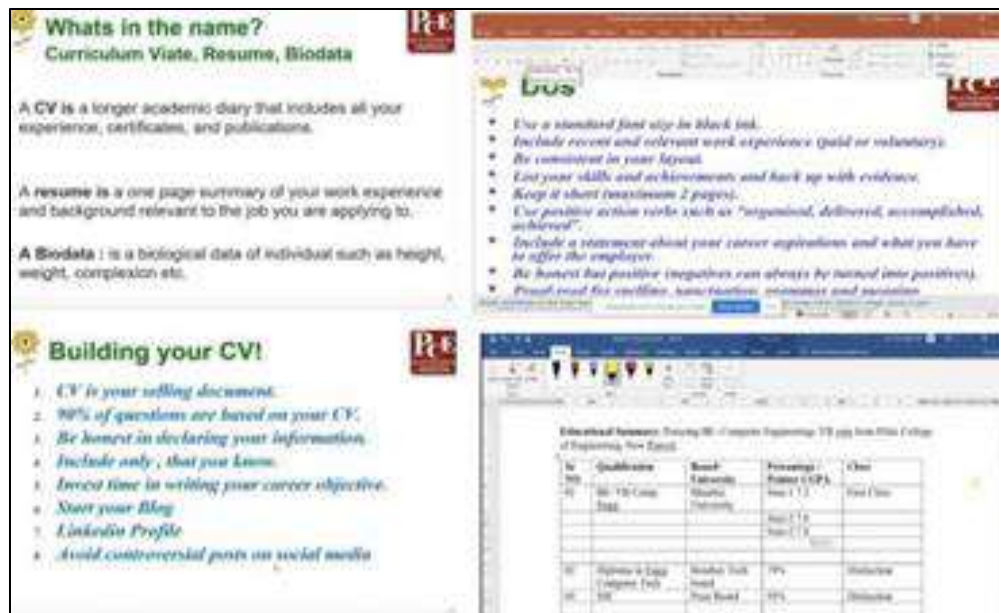

Various slides of the event

A Webinar on How to Prepare for The Interview

The Training and Placement Committee of Pillai College of Engineering, New Panvel conducted a webinar “The Interview” on 12th August 2020. The objective of this event was to guide the students to understand how the placement procedure works and to groom them for the same. The speaker Dr. Prashant Lokhande commenced this webinar with a brief introduction of the objectives to be discussed throughout the webinar. He started with the importance of the interview and why most of the rejection occurs there. The speaker highlighted how one should be prepared for the competency interview. STAR methodology was explained. After this, a list of frequently asked questions was presented which was categorized as personal, job, general knowledge, what if and probing questions where he simultaneously shared expected answers. He then showed a job description from ‘Systemics’ as a sample and described what qualities they seek for, the sort of preparation to be done. Also, the interview marking sheet was displayed where what stands more weightage was cleared so that candidates know what to focus on during the process of interview. How interviews will be taken online was also explained. The speaker then answered a couple of queries raised by the students about the interview related doubts, the placement procedure during pandemic and thus clearing all the doubts.





Various slides of the event

Mechanical and Automobile Placement Session

In due with the placement season Training and Placement Committee of Pillai College of Engineering, New Panvel conducted a “Mechanical and Automobile Placement Session” by Dr. P.S. Lokhande on 13th August 2020. This webinar was organized by TPC- PCE under the guidance of principal Dr. Sandeep Joshi and Head-Training & Placement Dr. Prashant Lokhande of Pillai College of Engineering. The objective of this event was to brief the students about the upcoming companies coming for the placement, the various opportunities in the IT sector and the employment situation ahead of the COVID-19 period. The webinar began with a welcome of Dr. Prashant Lokhande by Dr. Sandeep Joshi. Dr. Prashant Lokhande started the webinar by addressing the students on Career Opportunities in IT for Core Engineering branches. He explained how the manufacturing sector and production sector has been affected by this pandemic as there is no work from home opportunity for them. He introduced to the audience the core engineering professionals from non-IT background who are successful in the IT background. He then showed the list of companies which are visiting the college. He then shared the slide of typical placement day process.

In between of the webinar he then answered the questions of the students who had queries. He also explained the eligibility criteria required to sit for the interviews. Various questions were also answered by the principal Dr. Sandeep Joshi and various other professors simultaneously. At last, the principal gave the insights about the industry expert lecture organized by the faculties where the students can put forth their queries considering the relevance of the speaker and can get real-time answers. Last but not the least, the event was a grand success with many students interested to sit for the placements, and thus the webinar was concluded by the speaker Dr. Prashant Lokhande.



Slides of the Event

Gateway to Success Webinar

In accordance with the COVID-19 situation, Training and Placement Committee of Pillai College of Engineering, New Panvel conducted a “GATEWAY TO SUCCESS WEBINAR” in association with Ekeeda by Prof. Abhishek Barve, Prof. Mukesh Rai and Prof. Sameer Velankar on 18th August 2020. The objective of this event was to advise the students on how to crack the GATE exam with a remarkable score, Job opportunity through GATE, GATE study plan / How to study or crack GATE and Tips and tricks to score high. The webinar began with the first speaker Prof. Abhishek Barve where he introduced himself to the audience and also introduced his organization E- KEEDA which is an online platform which gives online lectures and online solutions. He explained about PSU JOBS and also provided insights for an individual on the opportunities in the government sector after successful qualification of the GATE exam, also mentioned the list of PSUs throughout the country and their payment criteria.

He gave the information on how GATE scores are preferred in core companies. He explained which higher course an individual should opt for after a successful completion of the Bachelor's degree and gave the list of the top colleges in India for Post graduate degree. The most important highlighting point of his talk was the PRADHAN MANTRI RESEARCH FELLOWSHIP GRANT which is provided during the Masters studies. After all this he explained the structure of the GATE exam which is a Computer-based test. The next speaker down the line was Prof. Sameer Velankar. He explained about the Campus placement process. At the last the webinar was concluded by Prof. Abhishek Barve where he explained about the test-series provided by E-KEEDA for all the GATE aspiring candidates. He then answered a couple of queries raised by the audience about GATE preparation.



Various slides of the event

Career in the Indian Armed Forces Part 2

In Commemoration of the Golden Jubilee year of Mahatma Education Society, Training and Placement Committee of Pillai College of Engineering, New Panvel conducted a motivational talk on “CAREER IN THE INDIAN ARMED FORCES PART: 2” by Col. Arun Malhotra, Capt. Supriya Patil and Mrs. Ruby Talukdar on 5th September 2020. The objective of this event was to guide the students regarding career opportunities in the Indian Army, the challenges our soldiers face everyday and how they overcome every difficult situation. The webinar began with a patriotic song and a warm welcome of Col. Arun Malhotra, Capt. Supriya Patil and Mrs. Ruby Talukdar by Dr. Prashant Lokhande. An introduction speech was given by Col. Arun Malhotra, there was a short video played for the audience about the Indian armed forces followed by the speaker Col. Arun Malhotra greeting the audience as well as faculty members. Later, the speaker began to address the audience by sharing his personal life experience as an Indian Army Officer. Col. Arun Malhotra provided information about the recruitment process in the Indian Army and the eligibility criteria. He addressed the audience by providing information on organisational structure in the Indian armed forces where on the top is the commander in chief - The President officer followed by ministry of defence and under it there is combined defence staff. The talk was later followed by Mrs. Ruby Talukdar. She told the audience about the SSB testing procedure and the different stages in it. The most important thing she highlighted during her talk was the essential qualities that an army officer should have. The next speaker down the line was Capt. Supriya Patil where she began to address the audience by sharing her unique qualities, her family background . She mentioned the different entry schemes for an Indian woman to enter into the Indian army - SSC (Non - Tech) Women, SSC (Tech) Women, NCC (Spl) Entry Women. Between the talk a video was played on the daily routine of cadets at OTA Chennai.



Various slides of the event

Overseas Education – Suny Oswego

The Training & Placement Committee of Pillai College of Engineering, New Panvel conducted a webinar for “Overseas Education – Suny Oswego” on 4th December, 2020. The objective of this event was to make the students familiar with the education process abroad and clear all the queries regarding the same. The speaker Maria Kopnitsky who was in conversation with us from the U.S.A. commenced this webinar with a short overview of the webinar’s agenda which was lined up as Future Prospects, Complete Application Process, Post Study Visa, Part-Time Jobs and Scholarships. She explained how studying abroad can benefit us in the future by improving contacts, meeting young minds from various countries, getting to know another country and perfecting another language, better job opportunities.

Then she gave detailed information about the steps in the application process which she stated as; apply online, submit transcripts, report ACT or SAT scores, submit a recommendation and the last one is to check application status. Then she spoke about how one can apply for a study visa, the period for which it lasts and its renewal. She also mentioned how part-time jobs can help pay a few extra bills or fund leisure activities, travel costs, etc. She also stated the rules and guidelines of working according to the visa type. The type of part-time jobs one can opt for was also discussed. Later, she gave the students the available scholarship details. She shared a list of scholarships provided by the Indian government along with the scholarships provided by Suny Oswego for international students and explained the criteria and policies for the same. Then, the question-answer session was conducted which resolved all the queries of the students, giving them a bright insight about what Suny Oswego offers for international students and cleared all the myths about studying abroad.

Overseas Education – Stevens Institute of Technology

The Training & Placement Committee of Pillai College of Engineering, New Panvel conducted a webinar for “Overseas Education – Stevens Institute of Technology” on 5th December, 2020. The objective of this event was to make the students’ education process abroad easier with Stevens Institute of Technology and clear all the queries regarding the same. The speaker Ms. Simran Kaur commenced this webinar with a short overview of the webinar’s agenda which was lined up as Future Prospects, Complete Application Process, Post Study Visa, Part-Time Jobs and Scholarships. She explained how studying abroad can benefit us in the future by expanding our networks which in turn increases opportunities for us to empower new ideas, meeting young minds from various countries, getting to know another country and perfecting another language. Then she spoke about how one can apply for a study visa, the period for which it lasts and its renewal. She also mentioned how part-time jobs can help pay a few extra bills or fund leisure activities, travel costs, etc. She also stated the rules and guidelines of working according to the visa type. The type of part-time jobs one can opt for was also discussed. Later, she gave the students the available scholarship details. She shared a list of scholarships provided by the Indian government along with the scholarships provided by Stevens Institute of Technology for international students and explained the criteria and policies for the same.

Then, the question-answer session was conducted which resolved all the queries of the students, giving them a bright insight about what Stevens Institute of Technology offers for international students and cleared all the myths about studying abroad.

State Level Mega Job Fair 2020

In Commemoration with Mahatma Education Society- Pillai College of Engineering, New Panvel and the Department of Skill Development Employment and Entrepreneurship conducted a “STATE LEVEL ONLINE MEGA JOB FAIR” on 12th December 2020. The job fair was organized on the account of 80th birthday of Ex-CM of Maharashtra also the Party President of NCP Member of Rajya Sabha-Hon. Sharad Pawar. Three dignitaries- Shri Deependra Singh Kushwaha- IAS, Commissioner, Skill Development, Employment and Entrepreneurship, Mr. Shambhuraj Desai and Hon. Shri Nawab Malik-Minister, Skill Development, Employment and Entrepreneurship were present for the job fair which was conducted all over Maharashtra.

The objective of this event was to provide jobs to students ranging from SSC qualified to post-graduate. The webinar began with the introduction of the event by Shri Deependra Singh Kushwaha- IAS, Commissioner, Skill Development, Employment and Entrepreneurship. The introduction speech was later continued by Mr. Shambhuraj Desai where he gave more details of the job portal and the employment opportunities provided by the government. The next speaker for the event was Hon. Shri Nawab Malik-Minister, Skill Development, Employment and Entrepreneurship where he spoke about how the government will be providing jobs to almost 80,000 youths in the state.



Various slides of Event

Session on Building an Innovation/Product fit for Market

Training and Placement Committee of Pillai College of Engineering conducted a webinar on "Session on Building an Innovation/Product fit for Market" on 14 May. The speaker at the webinar was Mr. Shreekant Shiralkar, a seasoned management professional. The webinar was an

effort to familiarize students with prototyping, market readiness, and start-ups. In pursuit of achieving this goal, Mr. Shreekant Shiralkar adopted a unique application of Game-based-approach premised on experiential learning. Two teams with three students each were formed. A set of six words flashed on the screen. The teams were expected to come up with a logical idea relating to those words in 10 minutes which was reviewed by the audience through a google form. Speaker interrogated the team member's experience for those 10 minutes; articulating the final concept through conflicting ideas and mindsets, the speaker efficaciously explained how a market-relevant product can be built. Towards the end, Mr. Shreekant Shiralkar answered a few questions of the students. More than 70 students benefited from the unique approach of the webinar making it an absolute success.



PCE PILLAI COLLEGE OF ENGINEERING

INSTITUTION'S INNOVATION COUNCIL
BRIDGING THE KNOWLEDGE GAPS

TPC-PCE
TRANSFORMING POTENTIAL INTO IDEAS

Institution's Innovation Council

Session on Building an Innovation Product fit for market

14th MAY | 10 to 11.30 | LIVE ON
FRIDAY | AM | AM | ZOOM



Mr. Shreekant Shiralkar
Management Professional
(34 Years of Experience)

Author, Established & Developed Business Units For Fortune 500 Firms (Accenture, Bharat Petroleum, Tata Consultancy)

Co-Curricular Activities

Learn Without Limits- Coursera Courses

The Pillai Group of Institutions allows free registration for Coursera courses, thereby providing high- quality online learning opportunities to faculty, students and alumni at the various institutes of Mahatma Education Society. Dr. Avinash R.Vaidya, Head, Department of Electronics and Telecommunication Engineering and coordinator for this program, consistently pursued the request for their campus program and was successful in obtaining the approval on 01 April 2020. Since then, over 2000 learners from Pillai College of Engineering have benefitted from this course, with over 7700 plus courses completed and over 20,000 enrolled.

Coursera Course Details – Pillai College of Engineering

Category of Learners/ Branch		No. of Learners	No. of Enrolled Courses	No. of Completed Courses
FACULTY	Applied Science, Mathematics and Humanities	25	165	88
	Computer Engineering/ Information Technology	35	466	164
	Electronics and Computer Science/ Electronics and Telecommunication Engineering	35	344	212
	Mechanical Engineering/Automobile Engineering	32	271	165
STUDENTS	Automobile Engineering	119	753	222
	Computer Engineering	349	3410	1298
	Electronics and Computer Science	164	1486	541
	Electronics and Telecommunication Engineering	333	2692	1148
	First Year	305	2572	1020
	Information Technology	340	3693	1299
	Mechanical Engineering	277	2896	1175
ALUMNI	Automobile Engineering	19	166	39
	Computer Engineering	25	564	114
	Electronics and Computer Science	17	145	47
	Electronics and Telecommunication Engineering	25	266	56
	Information Technology	19	176	46
	Mechanical Engineering	54	403	139
TOTAL		2173	20468	7773

National Programme on Technology Enhanced Learning (NPTEL)

NPTEL is a project funded by MHRD, Government of India, initiated by seven Indian Institutes of Technology (Bombay, Delhi, Kanpur, Kharagpur, Madras, Guwahati and Roorkee) along with the Indian Institute of Science, Bangalore in 2003. It has the largest online repository in the world of courses in engineering, basic sciences and selected humanities and social sciences subjects. Anyone outside of the IIT system can do an online certification course from NPTEL and receive a certificate from the IITs through NPTEL MOOCs. These certificates enable the students to enter the work force or pursue further education and training. Pillai College of Engineering is an NPTEL local chapter and Dr. Gajanan N. Thokal, Associate Professor, Department of Mechanical Engineering is the institute level coordinator for this course.

Participant Enrolment Details - July 2020 to December 2020

Sr. No.	Name of the Learner	Role	Branch	Course Name
1	Samruddhi Satyavan Gavas	Student	Information Technology	Data Science for Engineers
2	Samruddhi Satyavan Gavas	Student	Information Technology	Introduction to Machine Learning
3	Samruddhi Satyavan Gavas	Student	Information Technology	Artificial Intelligence Search Methods For Problem Solving
4	Shivtej Muthyala	Student	Information Technology	Data Base Management System
5	Shivtej Muthyala	Student	Information Technology	Design and analysis of algorithms
6	Shivtej Muthyala	Student	Information Technology	Introduction to algorithms and analysis

Participant Enrolment Details - January 2021 to April 2021

Sr. No.	Name of the Learner	Role	Branch	Course Name
1	Om Kulkarni	Student	Mechanical	Engineering Thermodynamics
2	Dharmesh Gandhi	Student	Automobile	Fundamentals of Automotive Systems
3	Om Kulkarni	Student	Mechanical	Automatic Control
4	Varun Nityanand	Student	Mechanical	Inspection and Quality Control in Manufacturing
5	Ashish Sah	Student	Automobile	Operations Management
6	Om Kulkarni	Student	Mechanical	Steam and Gas Power Systems
7	Manali Ahirrao	Student	Mechanical	Mechatronics
8	Ameya Nijasure	Faculty	Automobile	Mechatronics
9	Dharmesh Gandhi	Student	Automobile	Experimental Methods in Fluid Mechanics
10	Om Kulkarni	Student	Mechanical	Industrial Automation and Control

Project Based Learning (PBL)

Project-based learning (PBL) is a powerful teaching method that has extensive benefits for students, ranging from critical thinking to project management to self-confidence. Project-Based Learning is usually a collaborative process, which allows students to practice their communication skills and to learn to work together.

This new generation is really exposed to advanced gadgets and technologies. With the help of PBL, students are utilizing subject knowledge to implement and design the problem statement given by the department. Every semester the Department suggests realistic problems and expects very simple solutions using easily available materials and components from the student.

Objective—Project-based learning is an instructional approach designed to give students the opportunity to develop knowledge and skills through engaging projects set around challenges and problems they may face in the real world.

In essence, the PBL model consists of these seven characteristics:

1. Focuses the student on a big open-ended question, challenge, or problem to research and respond to and/or solve.
2. Brings what students should academically know, understand, and be able to do into the equation.
3. Is inquiry-based.
4. Uses 21st-century skills such as critical thinking, communication, collaboration, and creativity, among others.
5. Builds student choice into the process.
6. Provides opportunities for feedback and revision of the plan and the project.
7. Requires students to present their problems, research process, methods, and results.

Methodology

1. Create a groups (4-5 students in each group)
2. Identify the Problems
3. Provides solutions to the problems.
4. The students work in groups and assign and distribute various aspects of work so as to realize the project based on a timeline of about 2 to 3 months.
5. Queries and doubts are clarified by interactions with the PBL coordinators and subject experts.
6. Prepare the project report.
7. Present the Project to the experts.
8. Finalize Winners

Department of Computer Engineering

PBL Coordinators:

Division A: Prof. Sheetal Gawande

Division B: Prof. Suhas Lawand

PBL Topics:

Sr. No.	Division A	Division B
1	Online Portal for Health Checkup	Fitness Management System
2	Website for laptop suggestion.	College Registration System
3	Online portal for salon appointments.	Online Pharmacy Store
4	Online ordering system for College Canteen	Stray animal helper
5	Industrial Visit Management System	Scheduler for offline shopping, prioritizing social distancing
6	Online portal for society essential commodities.	Smart Task Manager - An activity/task scheduler for organizations following work from home pattern
7	Attendance Manager	Mobile Comparison Website.
8	Agriculture Management System	Grocery shopping website
9	Online Digital Library	COVID-19 prevention commodities purchasing website
10	Online Portal for a Local Pottery Shop	A Resume Building Website
11	NGO and Fundraising based Application	Home Inventory System
12	Online Electricity Bill Pay Portal	Web application for Construction company
13	online fuel delivery app	Website for mental health consultancy
14	Website for Hiring Caretakers	Online database related to films,tv shows and more.
15	College Management System	Online Course and Examination Management System
16	Stock Market Tracker	Online Car rental system
17	Regional Temple Information and booking	Project Management System
18	Online Turf Booking	E-commerce website for children

Winner of PBL

Sr.No.	Name of student	Title of Project	Section	Rank
1	Rhugved Kale	Agriculture Management System	A	1
	Varun MK			
	Akash Parthe			
	Spandana Shetty			
2	Anant Vishwakarma	Online Portal for Health Checkup	A	2
	Niranjana Badgujar			
	Prasad Badhan			
	Siddharth Shah			
3	Alex Sebastian Vettithanam	Online ordering system for College Canteen	A	3
	Aditya Sivaram Nair			
	Sidharth Nair			
	Mohanish Ghate			
4	Srivenkatesh Nair	Fitness Management System	B	4
	Abhinav Menon			
	Manish Pillai			
	Sujith Kurup			



AGRICULTURE MANAGEMENT SYSTEM

Submitted by -

Rhugved Kale	A-25
Varun MK	A-35
Akash Parthe	A-48
Spandana Shetty	A-58

Page 2 / 12

Fig. 4.2.6:Customer Dashboard

Department of Information Technology

PBL Coordinators

Division A Prof. Jinesh Melvin.

Division B Prof. Mimi Cherian

PBL Topics:

Topic Name	Abstract
Social Distancing	This project is based on the Idea of maintaining social distance. Considering the current situation the device which will be made in this project will be a distance measuring device which will be directly linked to the system. For instance it can be used at a counter which is generally crowded, at specific distances and the devices will be linked to the system, if a person comes too close to the counter there will be a beep. Even after the pandemic situation is over such devices can be used at banks, hospitals on a chaotic day or at sensitive places where people should not cross a specific distance.
IOT Family Health Monitoring System using Android App	The rising growth of IOT has made an enormous effect on human services. Health monitoring systems are gaining their importance as the fast-growing global elderly population increases demands for caretaking. Family Health monitoring system records the family members's heart beat rate, temperature and blood pressure. Pulse rate, blood pressure and body temperature readings are recorded so that person's health can be monitored from anywhere in the world over internet. The family health status is stored using an Android app in order to control the device using the app.
Pet Feeding System Using IoT	Using IOT, we will make a remote pet feeding system for pet owners as usually they cannot take pets everywhere they go. We will make use of sensors to identify whether the pet is in vicinity of the feeder. And this will give notification to the owner's device. Then after owners permission from his device, the feeder will release some amount of food in the bowl for the pet.
Smart Cradle System	The current number of working mothers has greatly increased. Subsequently, baby care has become a daily challenge for many families. Thus, most parents send their babies to their grandparents' house or to baby care houses. However, the parents cannot continuously monitor their babies' conditions. Thus, we have come up with an idea to design a Smart Cradle System using IOT which will help the Parents to monitor their child even if they are away from home & detect every activity of the Baby from any distant corner of the world. This cradle swings automatically on detection of baby cry sound. Also it activates buzzer and gives alerts on phone.



Flood detection system	Flood disaster is one of the most frequent natural disasters that occur all around the world. For flood prone area or countries, flood management is an essential part of their governance. The flood detection system is basically a flood warning mechanism that can detect the water level and measure the speed of the rise of the water level. It will give an earlier notification to evacuate before the water rises to the dangerous level. The measurement result is sent as the alert to a mobile phone through short message service (SMS). This project is designed on the IOT-based platform where data from the sensor is collected at the processor and alert is generated and transmitted as SMS to a smartphone. The users will also be notified through email. Also a buzzer will be used as an alarm to warn. it,whereas a seller can upload their books that can be viewed by sellers to purchase them
Smart Mirror	A smart mirror is a two-way mirror with an electronic display behind the glass. The display can show the viewer different kinds of information in the form of widgets, such as weather, time, date, and news updates.An IR frame is used to add touch screen functionality to the mirror . Magic mirror modules for touch control can be added to control the mirror.

Department of Electronics and Computer Science:

Class: Third Year Semester: V (July- December 2020)

PBL Coordinator: Prof. Swati Patil

PBL Topic: Android Application Development

The students were asked to develop an Android App, which required knowledge of subjects such as Microprocessors and Microcontrollers, Design with Linear Integrated Circuits and Database Management Systems. This project helped them in gaining valuable information and practical knowledge on several topics like designing web pages using html & css, designing of android applications, JavaScript, PHP and management of database using MySQL.

This topic was decided keeping in mind the current pandemic situation, where consumers have adapted to online shopping for various needs, right from basic necessities like grocery, vegetables to other luxury goods.

To design a platform for the various sellers to make their product available for selling online.

This application will help salespersons in managing the various types of Records such as client details, supplier details, product list and help to easily sell the product. The user can add a new product into the list by name, price or delete any product from the list which is not available in the market. It allowed changing the price of the product not affect the price registered in the catalogue of products. It shows how much the quantity of each product is present in the inventory. It has an option to filter the products. It allows to record the customer details and show when he last came, what products he bought that day and the total price of the products. It records and shows the supplier details like the name of supplier, last visit and amount. It also displays how much profit he earned that day and how much is initial money at the opening of the day and total money at the closing of the day.

List of projects developed by the students:

- Smart Grocers
- Library Management System
- Smart Buy
- CarBot (IoT)
- Indian Heritage and Culture
- Electronic Components
- Online Movie ticket booking
- Food delivery
- Library Management System
- E-learning App
- Book Addict: Online Books Shopping Store

Students were divided into 15 groups, each group having 3 to 4 students, worked on different application development problems. Most of the groups could implement the prototype and had demonstrated their ideas to the internal examiners on 6th November 2020.

Few Screenshots:

1. E Learning App

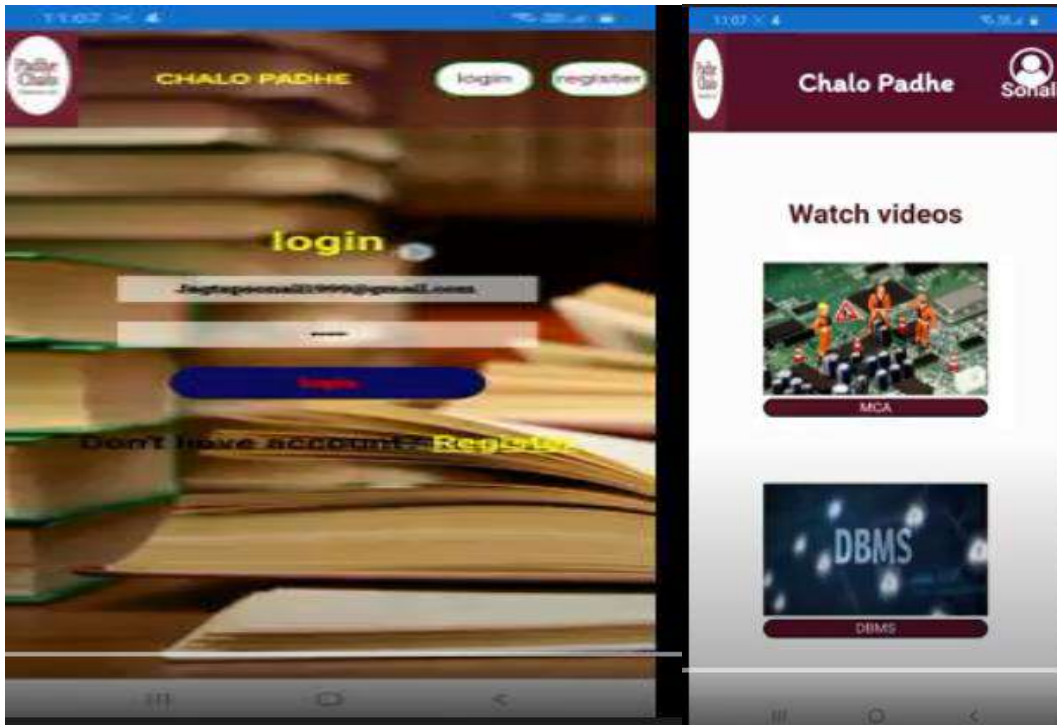

2. Library Management System

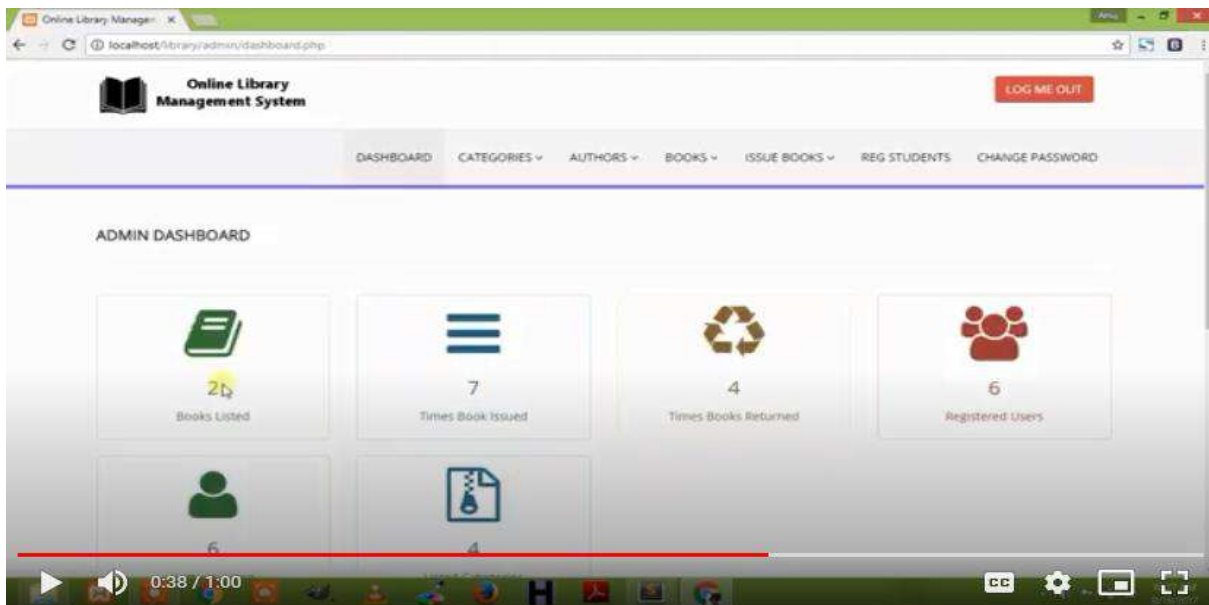

3. Online Smart Grocers App



4. Online Electronic Shopping App



5. CAR BOT

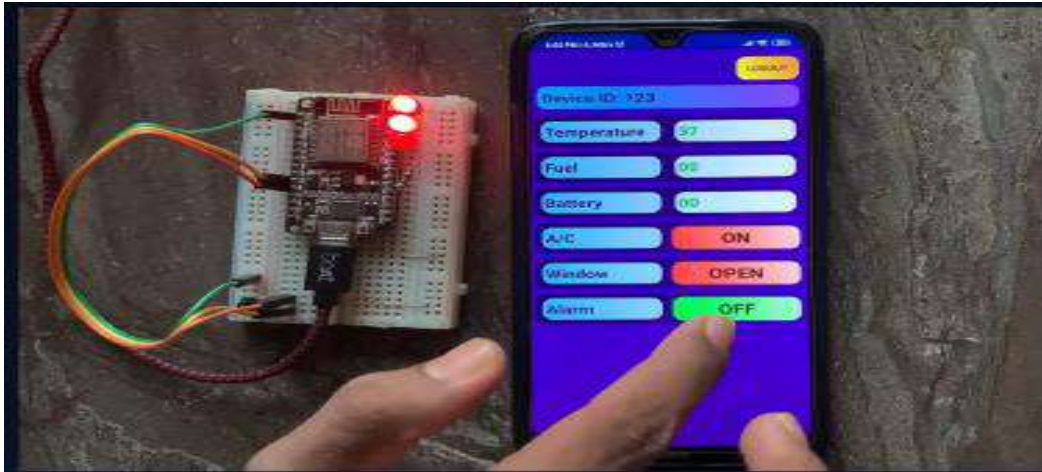

Class: Third Year Semester: VI (January- May 2021)

PBL Coordinator: Prof. Swati Patil

PBL Topic: **Voice Controlled Home Automation System**

An Android application and Google Assistant were used to build a voice control system for home automation using arduino and bluetooth module HC-05. This project helped the students to gather knowledge on software simulations required for home automation systems. They developed various applications like control of fan, AC, light, door lock on proteus software through voice commands on mobile application. Along with this, students had included an additional feature such as control of air purifier, television, door lock, chimney, fridge, wifi, washing machine, smart watering system etc. This application will help handicapped and old aged people to control home appliances and alert them in critical situations.

The students were divided into 14 groups, each having 3 to 4 students.

To identify progress of the project, 1st stage PBL evaluation was conducted on 23rd April 2021. Many students have implemented the prototype and demonstrated their ideas to the internal examiners. The final PBL exhibition was conducted on 17th May 2021.

Few Screenshots:

1. Home Automation System

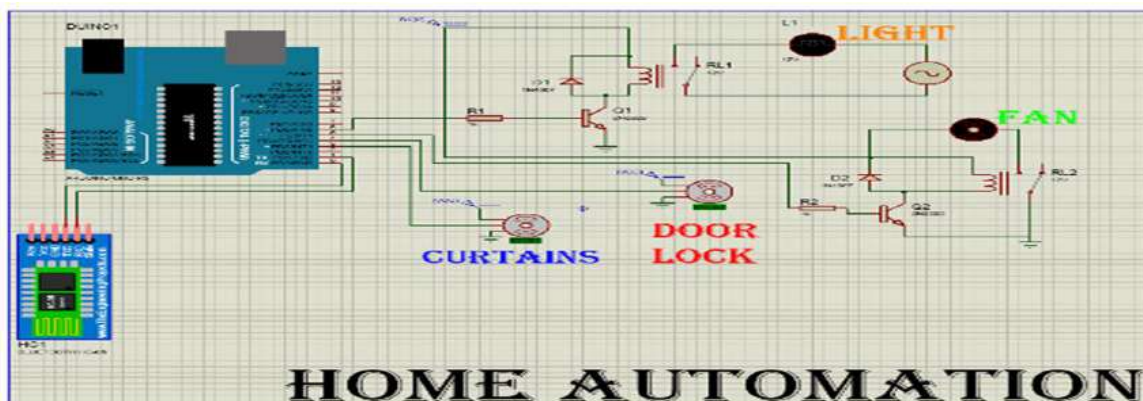

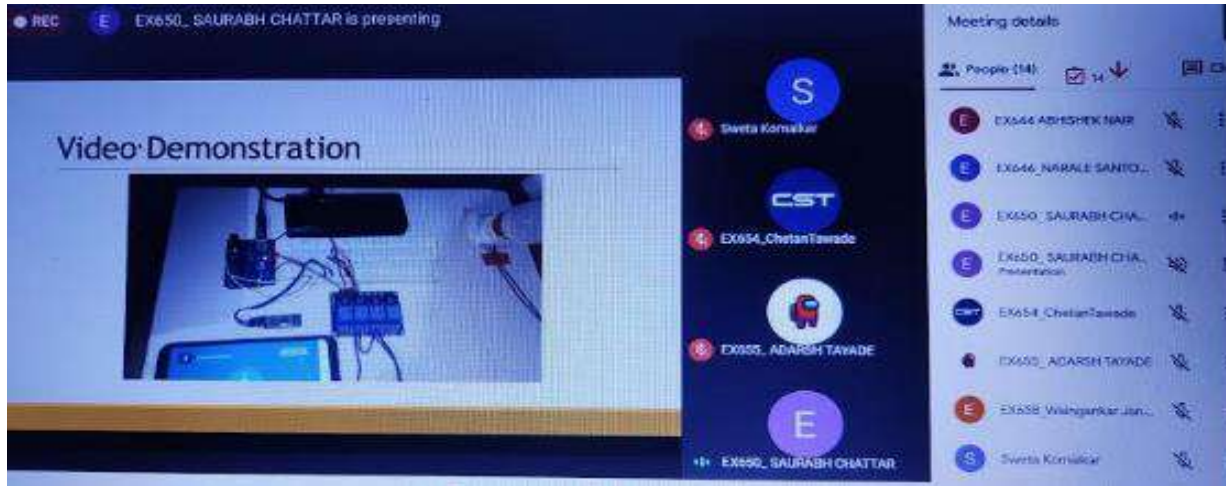

2. Operation of Fan:



3. Operation of Television:



4. Operation of Curtain:

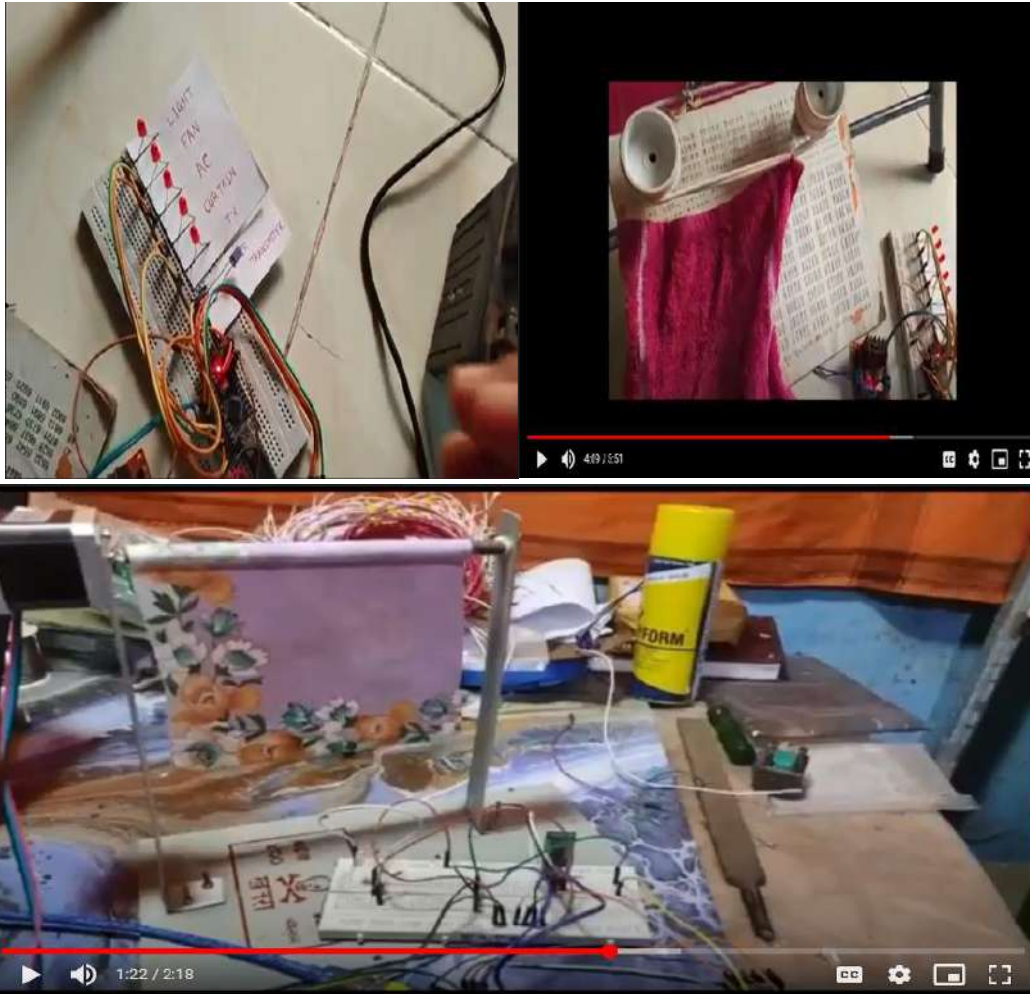

Department of Electronics and Telecommunication Engineering:

Class: Third Year Semester: V (July- December 2020)

PBL Coordinators: Prof. Florence Simon and Prof. Harsha Sharma

PBL Topic: Android Application Development

The project was to design Online Shopping Application, identical to the one described for the Department of Electronics Engineering. Students were asked to develop this application for shopping of groceries or electronic gadgets using Firebase, Android studio or any other suitable platform.

There were 16 groups in TE EXTC A and 15 in TE EXTC B.

List of applications developed by the groups:

- Supercook (Utility App)
- Online Shopping Application
- Grocery Shopping Application
- Quiz App Output
- Music Player App
- The Food Delivery App
- The Shopper's-Shelf Output
- Shopping App For Electronic Devices
- Electronic Component Output
- Age Calculator Output
- Sports Event Management System
- Shopping Website
- Scientific Calculator Output
- Employee Details App
- News And Weather App

PBL exhibition was held online on 07 November 2020 where students showcased their projects. Project groups were examined by faculty members of Electronics and Electronics and Telecommunication departments.

Few Screenshots:

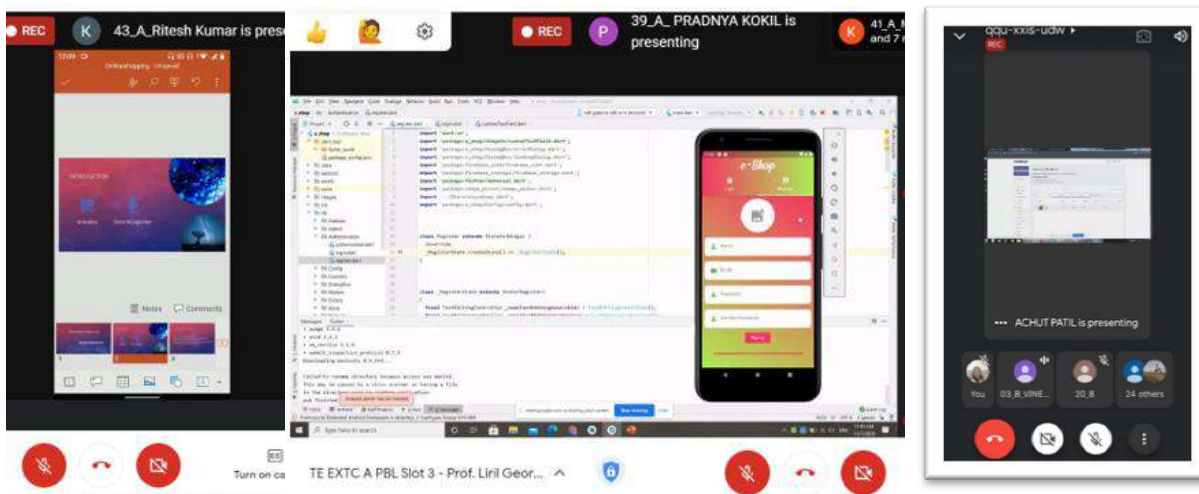

Class: Third Year A & B Semester: VI (January- May 2021)

PBL Coordinators: Prof.Rubina Shaikh and Prof. Aboli Khedkar

PBL Topic: Voice Controlled Home Automation System

The topic and description are same as those elaborated for the Department of Electronics Engineering. There were 15 groups from TE EXTC A and 16 from TE EXTC B who demonstrated their projects during online PBL exhibition organised in the month of May 2021.

Department of Mechanical and Automobile Engineering

Class: Third Year

Semester: V (July- December 2020)

PBL Coordinator: Dr. Rashed Ali

For PBL, The department of Mechanical & Automobile engineering has floated the problem on developing virtual experiments of their choice using software with which they are acquainted.

The Scope of the topic:

- A virtual experiment is a powerful educational tool that enables students to conduct experiments at the comfort of their home. An excellent opportunity to engage students with technology and in parallel to avoid unforeseen disruptions, as happened recently due to pandemic.
- Virtual experiments can provide a powerful solution for students during COVID-19 pandemic. Students can progress to their studies without any disruptions since important experiments can be conducted online at home.
- Development of such virtual experiments will provide the student with a great exposure to design the experiments in a way they want to analyze the parameters and synthesis the input.

Objectives:

- As PBL problem that involves the students to develop some hardware solution is not possible due to current pandemic scenario. There is need to undertake PBL that involves simulation/analysis using software etc.
- This will develop software skill of the student.
- Students are required to design the experiments of the area/topic of their interest.
- Students can select the topic/experiment in consultation with subject teacher/mentor who guides the student in selection of the experiment and development of software.
- Students were instructed to design the experiment using any programming language/software.

Students have carried out the development of virtual experiments on the following topics.

The topics selected are from the syllabus of Mumbai University.

Mechanical Engineering

- Study of Fuel Injection System C. I. Engine
- To determine the natural frequency for longitudinal vibrations of helical spring
- To determine poles and zeroes and plot root locus graph
- Study of Logic Gates & Root locus - Bode plot from transfer function
- PD control for an automated system
- Determination of thermal Conductivity of insulating powder
- Determine type of damping, damping ratio & natural frequency of given system.
- Heat transfer through Insulating Powder
- Archimedes Principle
- Heat transfer by conduction
- Critical Radius of Insulation or Effect of Area On The Heat Transfer

- Heat transfer from Extended Surfaces (Fins)
- Morse Test
- Bifilar Suspension, Simple Pendulum, Compound Pendulum
- Determination of Time Response
- Study the Carburetors
- OHMS LAW
- To develop speedometer (Generalized Measurement system)
- Conductivity of insulation powder
- SPRING TEST
- FLOW THROUGH VENTURIMETER
- Orifice Meter
- Determination of time response specification of given time

Automobile Engineering

- To check stability of system using Routh's criteria
- Dismantling and Assembly of Ignition system
- Dismantling and Assembly of Brakes (Disc and Drum)
- Study of fuel injection system
- Dismantling & Assembly of Transmission
- Dismantling and Assembly of Differential
- Dismantling and Assembly of Brakes (Disc and Drum)
- Dismantling and Assembly of Steering Gear box
- Dismantling and Assembly of Alternator
- Determining the emissivity of a given material
- Working of Lighting and wiring system in automobile
- Working of Sensors and Actuators in Automobiles
- State space analysis
- Dismantling and Assembly of UV joint of Propeller Shaft
- Working of Sensors and Actuators in Automobiles
- Dismantling and assembly of Clutch
- Dismantling and assembly of Clutch
- Working of Sensors and Actuators in Automobiles
- Working of Sensors and Actuators in Automobile

Students have learned and used the following software for developing virtual experiments.

- | | |
|-----------------|----------------|
| • G programming | • Turbo C++ |
| • Python | • C++ |
| • Matlab | • Solidworkds, |
| • HTML | • Labview |
| • Java Script | |

Snapshots of the PBL Evaluation

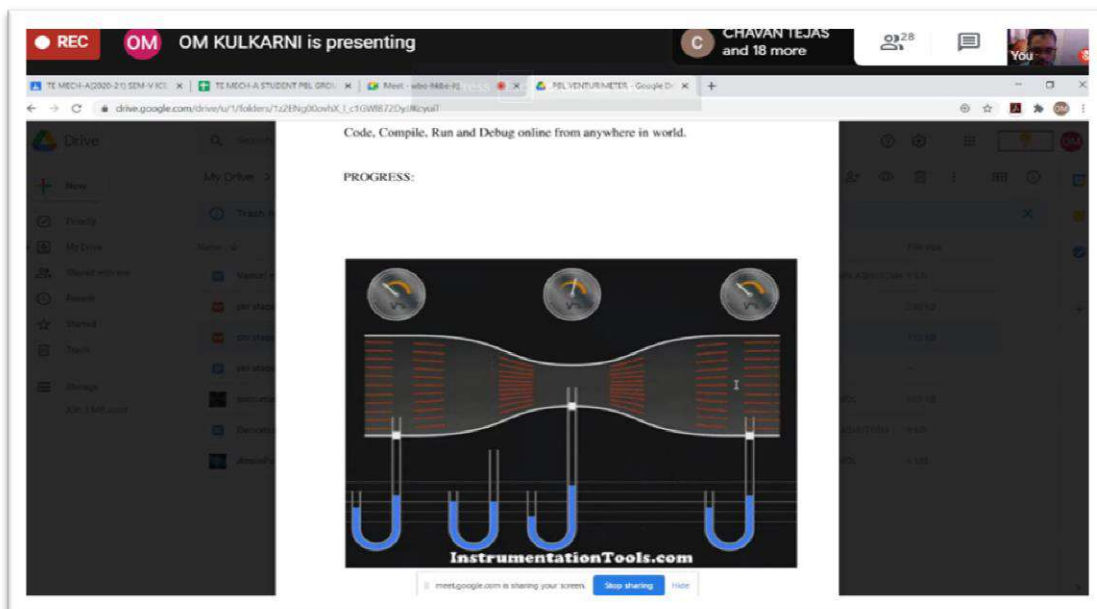
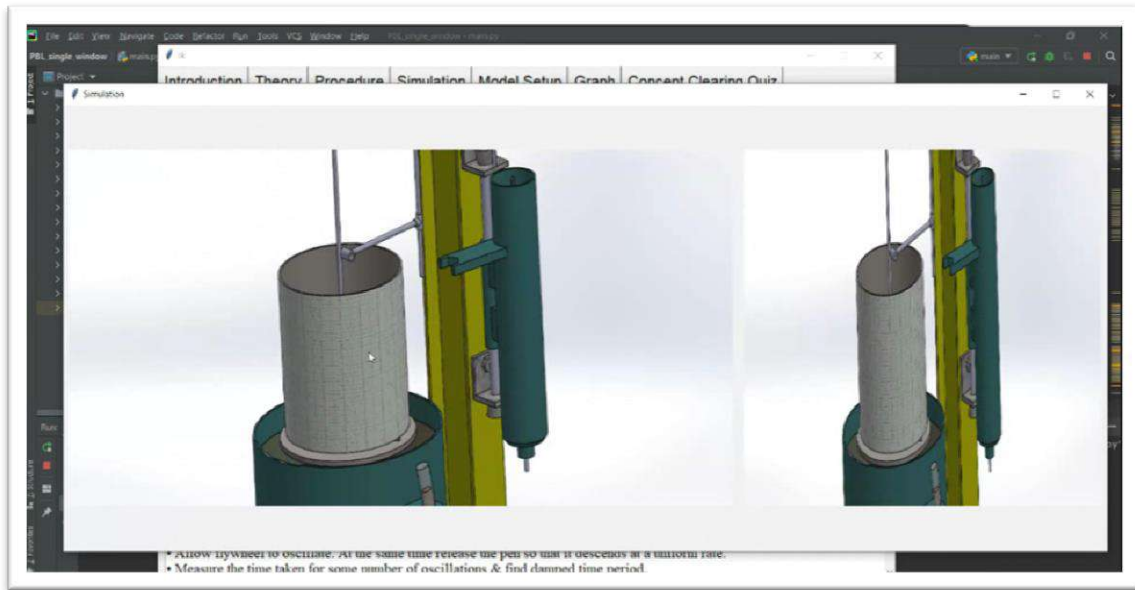

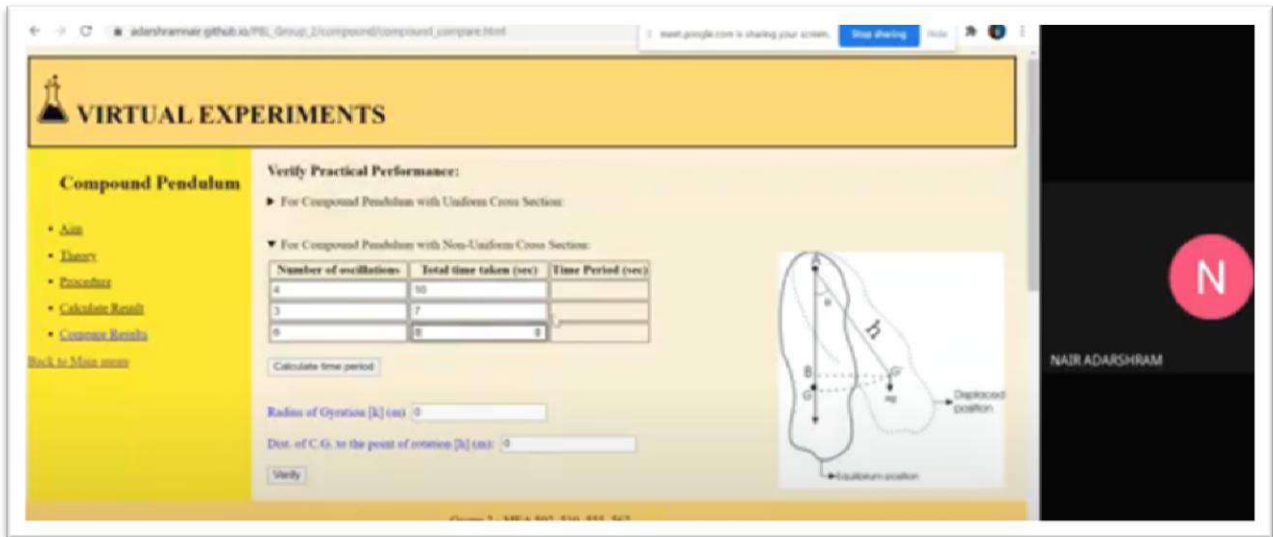

VIRTUAL EXPERIMENTS

Compound Pendulum

- Join
- Theory
- Procedure
- Calculate Result
- Compare Results

Back to Main menu

Verify Practical Performance:

- For Compound Pendulum with Uniform Cross Section
- For Compound Pendulum with Non-Uniform Cross Section:

Number of oscillations	Total time taken (sec)	Time Period (sec)
4	10	
3	7	
0	0	0

Calculate time period

Radius of Gyration [k] (cm):

Dist. of C.G. to the point of rotation [h] (cm):

Verify

Diagram labels: Displaced position, Equilibrium position

NAIR ADARSHRAM

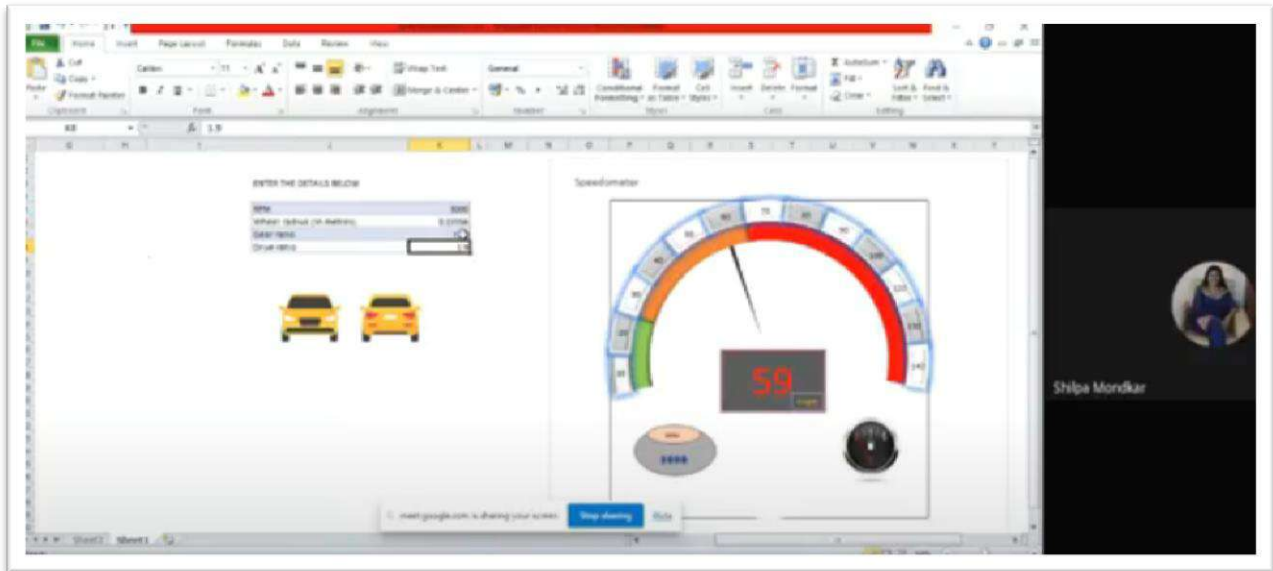

ENTER THE DETAILS BELOW

Make:

Whistle (optional) (in meters):

Color (hex):

Speedometer

59 km/h

Shilpa Mondkar

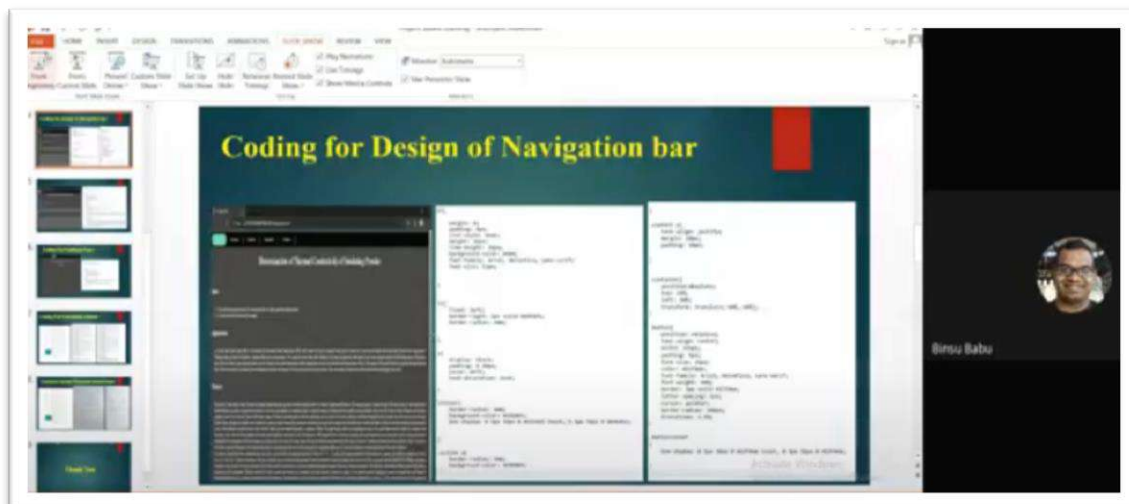

Coding for Design of Navigation bar

Navigation bar design and code examples.

Binsu Babu

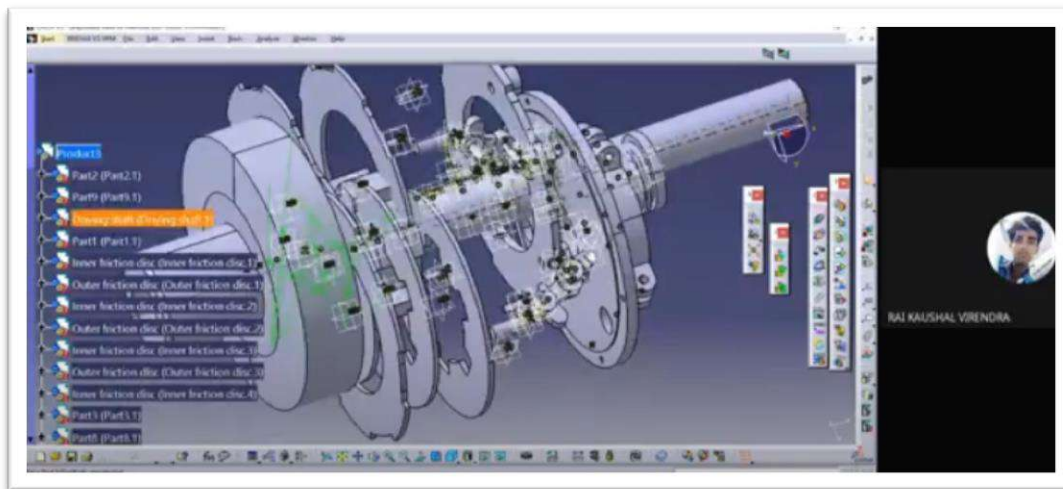
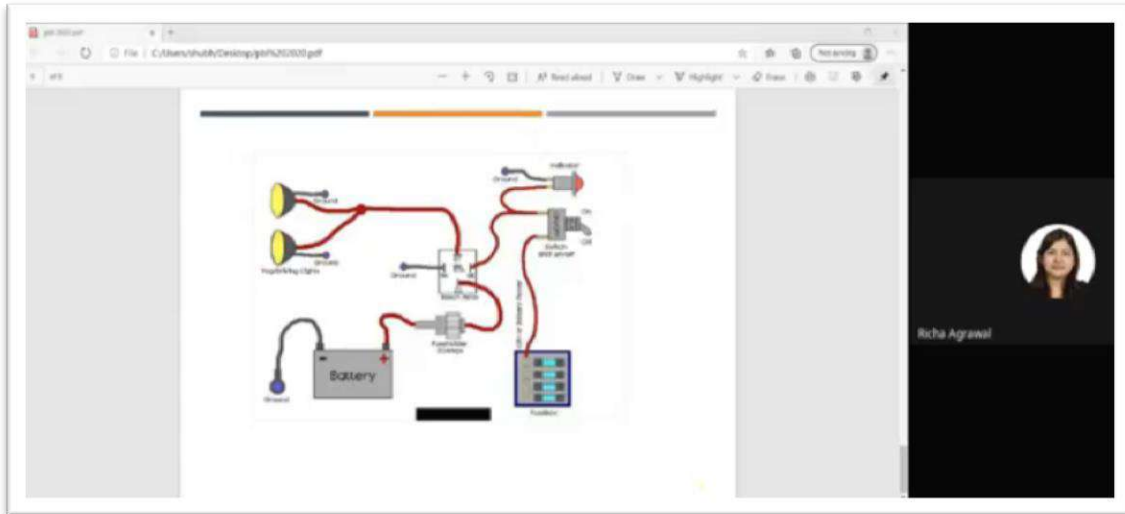

Class: Third Year

Semester: VI (January- May 2021)

PBL Coordinator: Dr. Rashed Ali

The department of Mechanical & Automobile engineering has floated the problem on developing virtual experiments of their choice using software with which they are acquainted for the PBL.

PBL Topic: Design, Modeling and Analysis of the Main Body Frame for a Typical Application

Students are required to perform structural analysis (design calculations, 3D modeling, and finite element analysis), followed by optimization of shape/material/dimensions as related to ergonomics &/or aerodynamics, of the main body frame for any one of the following applications:

1. Bicycle
2. Tricycle (seated) for a baby
3. Gymnasium Exercise Equipment (viz., Workout Weight Stand, Dumbbell Stand, Barbell Stand etc.)

Detailed study with respect to the following parameters is to be carried out:

1. Loads (dead and live, static and dynamic/shock/impact) acting on the main frame

2. Standard materials used for the frame
3. Aerodynamics
4. Ergonomics
5. Calculations (manual) of strengths of frame
6. Manufacturing methods used
7. Optimization studies of shape/dimensions/material
8. (to be conducted after complete structural analysis of the existing frame). Student groups are advised to conduct simulation studies (at least one or two iterations) on optimization parameters, and come up with an improvement in the savings of material, manufacturing, or improved aerodynamics defined by simulated drag coefficients etc.

Snapshots of the PBL Evaluation

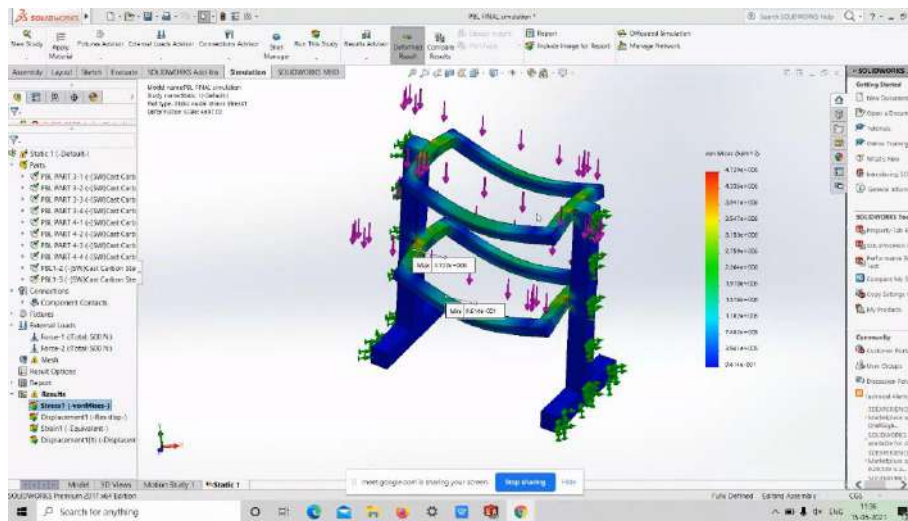
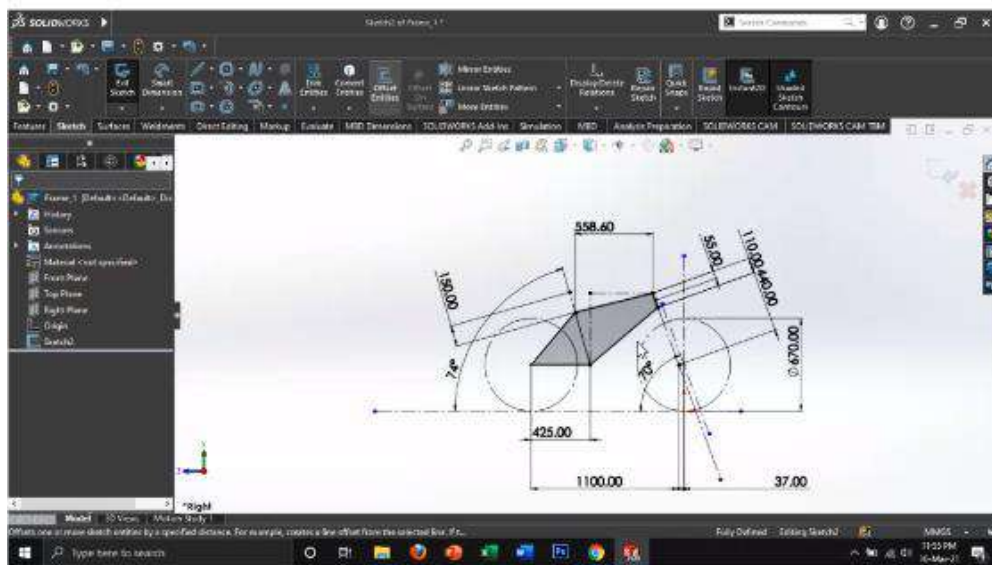

Spoken Tutorials

Spoken Tutorial is an initiative of National Mission on Education through ICT, MHRD, Govt. of India to promote IT literacy through Free Open Source Software (FOSS). Dr. Arun S Pillai, Head, Department of Applied Science, Mathematics and Humanities and Dr. Richa S. Agarwal, Associate Professor, Department of Mechanical Engineering are the coordinators from Pillai College of Engineering for the Spoken Tutorials. It is because of their sincere efforts and unending support, that Pillai College of Engineering in collaboration with IIT- Bombay Spoken tutorials, has successfully conducted 07 workshops, benefiting around 547 students and faculty all over the nation. A series of workshops were organised and conducted in coordination with different departments of the institute.



PCE
PILLAI COLLEGE OF ENGINEERING

A+
MAAC

PILLAI COLLEGE OF ENGINEERING
in association with
Spoken Tutorials
presents

**SOFT SKILL
WORKSHOP
SERIES-2020**

Certification by IIT Bombay

R Programming - 13th to 20th August
Applications of GeoGebra - 7th to 12th September
Python - 16th to 25th September
PHP & MySQL - 28th September to 3rd October
QCAD - 5th to 10th October

Workshop Fees
Student Outside PCE Rs. 500/-
Faculty Outside PCE Rs. 700/-
PCE Student and Faculty Rs. 200/-*
*The difference amount will be borne by PCE

**Tune Yourself To The
need of Research and
Industry 4.0**

REGISTER

Key Feature

- Sessions by Experts from PCE
- Interactive Sessions
- Assignments and Quizzes
- Participation and Completion Certificate from IIT Bombay and PCE

Details of Workshop Organised

S N	Name of the FOSS	Date		Participants				
				MES Student	MES Faculty	Outside Student	Outside Faculty	Total
1	R Programming	13 th – 20 th August, 2020	Prof. Shivapradeep Muthupandi Prof. Florence Simon	88	9	2	1	100
2	Applications of GeoGebra	7 th – 12 th September , 2020	Dr. Kuberal S. Prof. Mahesh Kudre	5	10	7	20	42
3	Python - Batch 1	16 th – 25 th September	Dr. Richa Agrawal Prof. Suchitra Patil	73	12	14	16	115
4	PHP & MySQL	28 th Sep – 3 rd October, 2020	Prof. Blessy Varghese Prof. Dhiraj Amin Prof. Amol Kharat	193	4	6	2	205
5	QCAD – Batch 1	5 th – 10 th October, 2020	Prof. Ameya Nijasure Prof. Binsu Babu	33	3	0	1	37
6	QCAD – Batch 2	20 th & 27 th February, 2021	Prof. Ameya Nijasure Prof. Binsu Babu	15	0	2	0	17
7	Python - Batch 2	22 nd – 27 th March, 2021	Aboli Khedkar, Prof. Sangeetha Selvan, Prof. M. Shivapradeep	28	0	2	0	30
Total				437	38	33	40	548

Internships

Economic and business environments are changing at a rapid pace due to globalization. Businesses and employers alike are in need of those who are qualified to work in these environments, possess relevant skills, and have proven capabilities to succeed in them.

An internship is one such door to opportunities which offers a valuable insight into industry. Among the many advantages that internships offer, they also promote skill development, enhances professional networking, thereby, resulting in successful outcomes after graduation. With every year passing by, Pillai College of Engineering has witnessed a significant increase in the number of students undergoing training at various companies/ organizations/industries. The placement cell of PCE provides all the necessary help to provide internship support to interested students.

Department					
Automobile Engineering	Computer Engineering	Information Technology	Electronics and Telecommunication Engineering	Electronics and Computer Science	Mechanical
9	59	80	72	37	60

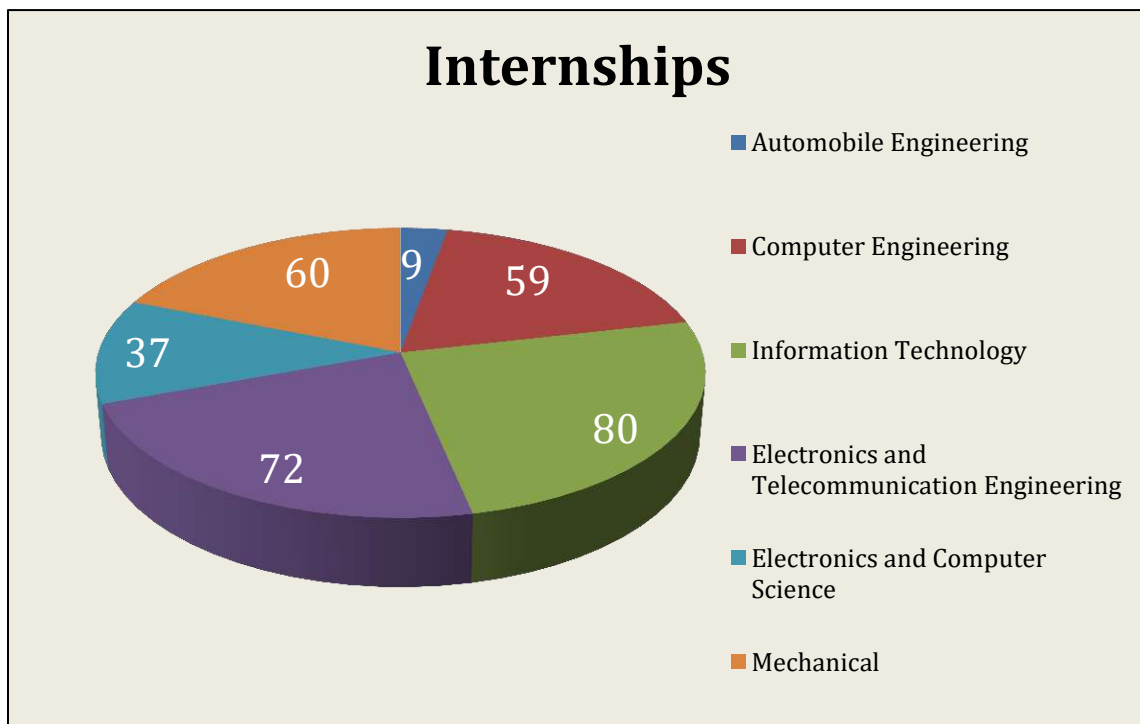

Deep Blue Season 6

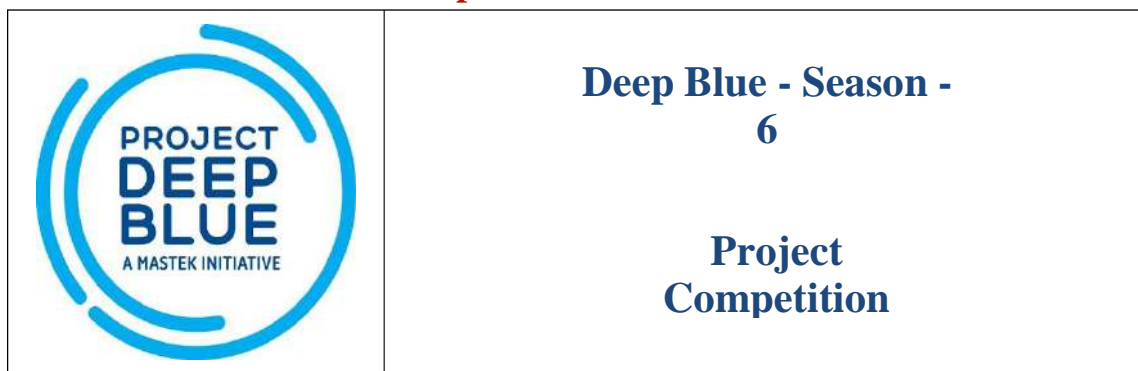

The Mastek initiative - Project Deep Blue, is an intercollegiate competition, encouraging engineering students to solve social problems using coding skills to come up with meaningful technical solutions over the course of three months.

As the name signifies, the competition promotes “Deep Thinking”, “Innovation” and awareness about the “Social Issues” in these young minds. It provides an early start, mentorship and industry exposure to the Entrepreneurs and Technology Leaders of tomorrow.

The Deep Blue Season 6 competition was decided to be conducted partly online due to covid-19 pandemic restrictions; however the Semi-finals and finals were decided to be held offline. Last date for the registration was 4th September 2020. A total of 67 teams from PCE registered for the competition. 40 teams submitted their abstract. The launch event for the 6th season of the Deep Blue competition was held virtually on 22nd Oct from 4 to 5:30 PM IST.

In the 6th season 10 teams from Pillai College of Engineering were selected for the Competition. Out of the 10 teams 7 teams made it to the Semi-finals which was held from 14th March 2021 to 18th March 2021 at Mastek office at Mahape. 1 team qualified for the finals of the event. The finals were cancelled due to Covid situation.

Details of Teams Participation	
Total Students Participated:	928
Total Teams Participated:	232
Total Colleges Participated:	10
Total Teams Selected:	58
Teams Selected from PCE:	10

Problem Statements for Deep Blue Season 6:

Theme 1: Crowd Counting Challenge – CCC

The problem is to count the number of people in a shoppingmall. Following are problem dimensions.



1. Use video feed and give count of people.
2. Use triangulation or any other algorithm to count people in the mall.
3. State the margin of error or confidence interval of the output and state assumptions used.

Theme 2: Predict Queue Wait time (PQT)

To Predict Queue wait time in a multi stage queue in a Hospital environment.

This problem has the following dimensions



1. Queue is a multi-stage queue.
2. At any station where there is a Queue, Doctor's Check-in Time, Patient Check-in Time and Patient Check-out Time will have to be simulated.
3. Predict wait time in a hospital Communicate wait time in real-time.

Theme 3: Air Quality Visualisation – AQV

This Problem challenges the participants to present an intuitive and easy to understand – visualization for the below mentioned parameters.

Visualize 3 layers of data in the M-ward of Mumbai city.

The 3 layers of data are



1. Air pollution in M-ward.
2. Health condition of population in M-ward.
3. Demographic data (age, etc) of population in M- ward.

Theme 4: Automation Society Security Task – ASST

Visitors in a housing society fall in the category of regular visitors like drivers, maids, milkman, sweeper, car cleaners, etc who visit on a daily basis and the other category is of infrequent known or unknown visitors (like guests, deliveryboys).

Record with timestamp registered regular visitors and their temperature check.

Facial recognition should take care of visual changes in appearance of a person

Theme 5: Geofencing using IoT – GOT

To use IoT for creating a virtual Geofence for accurate movement tracking of patients within hospital points from various sources. Covid patients to be registered and each one to be given a IoT tag/sensor. You can decide the sensor. The solution should offer continuous monitoring of the movement of patients within the hospital and not at static points in time.

Accurate position tracking is of paramount importance and will be the most important parameter while judging a solution.

Team Results at Deep Blue Season 6

Sr. No.	Problem Statement	Team Members	Department	Result
1	Geofencing using IoT –GOT	Akshay Savad	Information Technology	Semi Final
		Soham Lanke	Computer Engineering	
		Vaishnavi Garad	Computer Engineering	
		Saloni Gharge	Computer Engineering	
2	Air Quality Visualisation – AQV	Aditya Nair	Computer Engineering	Semi Final
		Snehal Mane	Computer Engineering	
		Anant Vishwakarma	Computer Engineering	
		Sidharth Nair	Computer Engineering	
3	Crowd Counting Challenge – CCC	Sonu Mondal	Information Technology	Semi Final
		Rohit Singh Rana	Information Technology	
		Dhruv Karotra	Information Technology	
		Lina Vitthal Pawar	Information Technology	
4	Crowd Counting Challenge – CCC	Sarika Jamdagni	Computer Engineering	Semi Final
		Mehnaz Uluwar	Computer Engineering	
		Eshani R Sawant	Information Technology	
		Devesh Tajane	Information Technology	
5	Automation Society Security Task – ASST	Aakarsh Verma	Information Technology	Final
		Pramod Baviskar	Information Technology	
		Neel Suba	Information Technology	
		Sakshi Jadhav	Information Technology	
6	Automation Society Security Task – ASST	Vaishnavi Salian	Computer Engineering	Semi Final
		Himani Patel	Information Technology	
		Ishika Joshi	Information Technology	
7	Automation Society Security Task – ASST	Manthan Gharat	Information Technology	Semi Final
		Rohan Maloor	Information Technology	
		Vighnesh Srinivas	Information Technology	
		Anjali Agarwal	Information Technology	

Overall Statistics of all colleges in the competition

College Name	Registered	Abstracts Submitted	Abstracts Selected	Solutions Presented	Finalist Teams
VESIT	60	55	16	11	1
KJ Somaiya Institute of Engineering and Information Technology - Sion	30	23	12	8	1
Pillai College of Engineering, New Panvel	67	39	10	7	1
M. H. Saboo Siddik College of Engineering	38	28	7	5	0
NYSS Datta Meghe College of Engineering	19	16	4	4	1
Shah Anchor Kutchhi Engineering College	18	14	5	4	0

Images of the Project Deep Blue Semi Finals held on 16th February 2020 at Mastek, Mahape.



ANUBHAV

Anubhav 2021 was organised from 17th of June to 19th of June on the virtual platform and streamed on the Youtube channel of Mahatma Education Society. The Student Council along with other committees was involved in organising this event.

Anubhav was conducted into 3 different webinars organised in 3 successive days. First session was organised for Mechanical and Automobile branch students, second session was organised for Computer Engineering and Information Technology branch students and third session was for Electronics and Telecommunication Engineering and Electronics and Computer Science branch students. Every year final year students from each department are selected as speakers for the session based on their impressive college records and achievements. The motive behind organizing this event is to make the students familiar with various strategies of maintaining a good pointer, conveying the importance of things like building resume, internships, co-curricular activities, participation in competitions, projects, and a lot more to make them understand the significance of all these aforementioned things after college. This event also helps students to realize the perks of being a part of student bodies and how it assists an individual to grow personally as well as professionally. Lastly, everyone mentions how the institute has played a crucial role in shaping each one of them into what they are today despite various obstacles tackled by them.

Students in considerable numbers turned up to take advantage of this wonderful opportunity. The event was attended by our principal, Dr. Sandeep Joshi, HoDs of all the departments and various faculty members. At the end of each session, speakers were asked a few questions by the host which were submitted in the google forms by the students. The speakers and the student bodies were appreciated for their efforts and were given best wishes for their future endeavours by professors and Principal Sir.

Day 1

On 17th June selected final year students of the Mechanical and Automobile department, who achieved milestones during their 4 year journey of engineering shared their valuable experience and suggestions to students. Event was started with the introduction of Anubhav by ISHRAE member, Mr. Aniruddh Achary.

Program Speakers:

Sr. No.	Speaker Name	Branch
Speaker 1	Ketan Jain	Automobile
Speaker 2	Sharvaree Chitre	Mechanical
Speaker 3	Gokul Nair	Mechanical
Speaker 4	Tanmay Kondalkar	Automobile
Speaker 5	Yash Borade	Mechanical
Speaker 6	Gaurav Shirwalkar	Mechanical

Gaurav Shilwalkar

Tanmay Kondalkar

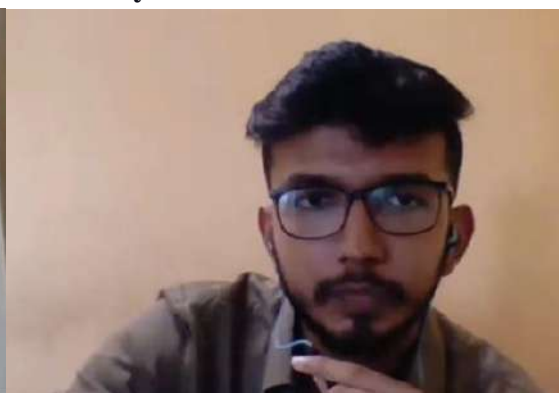
Sharvaree Chitre

Yash Borade

All speakers interacted with the audience where they answered queries asked by students. The webinar was concluded by Principal Sir appreciating all the speakers and wishing them luck for their future endeavours.

Day 2

On 18th of June selected final year students of the Computer Engineering and Information Technology department, who achieved milestones during their 4 year journey of engineering shared their valuable experience and suggestions to students. Event was started with the introduction of Anubhav by CSI-PCE member, Miss. Urvi Korgoankar.

Program Speakers :

Sr. No.	Speaker Name	Branch
Speaker 1	Anupama Rai	Computer Engineering
Speaker 2	Hrishikesh Agrawal	Computer Engineering
Speaker 3	Preetam B.A.	Information Technology
Speaker 4	Manthan Gharat	Information Technology
Speaker 5	Garima Singh	Information Technology
Speaker 6	Romax Rajeev	Computer Engineering
Speaker 7	Shreyas Shetty	Information Technology



Romax Rajeev

Garima Singh



Anupama Rai

Hrishikesh Agrawal

Speakers interacted with the audience followed thereafter. The webinar was concluded by Principal Sir and the HoDs of Computer Engineering and Information Technology departments appreciating all the speakers and wishing them luck for their future endeavours.

Day 3

On 19th of June selected final year students of the Electronics and Telecommunication Engineering and Electronics and Computer Science department, who achieved milestones during their 4 year journey of engineering shared their valuable experience and suggestions to students. Event was started with the introduction of Anubhav by ETSA-PCE Secretary, Miss. Shristi Shetty.

Program Speakers :

Sr. No.	Speaker Name	Branch
Speaker 1	Rohan Yadav	Electronics and Telecommunication Engineering
Speaker 2	Mehul Jain	Electronics and Computer Science
Speaker 3	Abhilasha S. Shinde	Electronics and Telecommunication Engineering
Speaker 4	Shudhanshu Bishwash	Electronics and Computer Science
Speaker 5	Nivedita Kale	Electronics and Telecommunication Engineering
Speaker 6	Sumedh Nerlekar	Electronics and Computer Science



Abhilasha S. Shinde



Mehul Jain



Rohan Yadav



Sumedh Nerlekar

Institution's Innovation Council

PCE has established Institution's Innovation Council (IIC) as per the guidelines of 'MoE's Innovation Cell (MIC)' in the year 2019. The initiative was to create a vibrant local innovation ecosystem, start-up supporting mechanism, establish function ecosystem for scouting ideas and pre-incubation of ideas and to develop better cognitive ability for technology students. After the success of IIC 2.0, the Institution's Innovation Council up-gradation meeting was held on 28th October, 2020 on an online mode. The meeting was called upon by IIC President Dr. Avinash Vaidya to congratulate all for attaining 5 Star Rating for the academic year 2019-20 and plan the activities for the First Quarter for the year 20-21.



5 Star Rating Certificate for the Year 2019 – 20

The IIC member details for the academic year 2020-21 are as follows:

Faculty Members	Member Type	Role on Committee
Dr Sandeep Joshi	Faculty	Head of the Institution
Dr Priam Pillai	Faculty	Convener
Dr Avinash Vaidya	Faculty	President and ARIIA, NIRF Coordinator
Dr Richa Agrawal	Faculty	Vice-President and Startup Activity Coordinator
Dr P S Goyal	Faculty	IPR Activity Coordinator
Dr Prashant Lokhande	Faculty	Internship Activity Coordinator
Dr Onkar Sahastrabude	Faculty	Innovation Activity Coordinator
Dr. Sharvari Govilkar	Faculty	Member
Mr Lalit Mehta	Faculty	Social Media Coordinator
Dr Celina Joy	External	Member: Incubation Center
Susanna Cherian	External	Member; Incubation Center
Prathmesh Desai	Student	Innovation Coordinator
Aditi Jaiswal	Student	Startup Coordinator
B. A. Preetam	Student	Internship Coordinator
Vaishya Vivek Kumar	Student	IPR Coordinator
Mehul Jain	Student	Member
Vijay Sharma	Student	Social Media Coordinator
Franav Pillai	External	Entrepreneur
Munawira Kotyad Pillai	External	Entrepreneur
Dr. Arun Pillai	Faculty	Entrepreneur

PCE IIC also formed the committee to implement and monitor the National Innovation and Startup Policy (NISP) and a resolution was passed on 19th August 2020. The Innovation and Startup Policy is available on PCE website for students and faculty reference. Link to Policy is <https://www.pce.ac.in/iic/>.

Members of NISP committee and their roles are mentioned below:

Name of the Member	Member Type	Role of the Member
Dr Sandeep Joshi	Faculty	Head of the Institution
Dr Priam Pillai	Faculty	Entrepreneur
Dr. Arun Pillai	Faculty	Startup Founder
Dr Richa Agrawal	Faculty	Startup Activity Coordinator
Prof. Varunakshi Bhojane	Faculty	Innovation Coordinator

Dr. Biswajit Panda	Faculty	IPR Activity Coordinator
Dr Prashant Lokhande	Faculty	TPO and Network Enabler
Prof. Salim Jafri	Faculty	Incubation and Preincubation Coordinator
Prof. Harsha Sharma	Faculty	Incubation and Preincubation Coordinator
Prof. Jinesh Melvin	Faculty	Incubation and Preincubation Coordinator
Mr. Sunit Sabale	External	Industry Associate, Brainiac Solutions
Mr. Swapnil Gaul	External	Industry Associate, NUMEREGION (TaraNG)
Mr. Maruti Pawar	External	Industry Associate, Amprionics Techno Pvt. Ltd.
Mr. Ajay Nair	Student	NISP Ambassador at PCE (T. Sec.)
Mr. Prathamesh Damle	Student	Startup Founder
Mr. Nishant Ravle	Alumni	Alumni Representative
Dr. Avinash Vaidya	Faculty	NISP Coordinator and Convenor

The Institution's Innovation council of MHRD's Innovation Cell organised a series of training programs exclusively for IIC members. During the current academic year, six of the faculty members and four students have completed these training sessions and are designated as "IIC - Innovation Ambassador". They are trained to play a role of mentor or guide for young minds in their pursuit of innovation and entrepreneurship.

The Faculty Innovation Ambassador are:

- Dr. Avinash R. Vaidya
- Dr. Richa Agrawal
- Prof. Harsha Ghadge
- Dr. Divya Padmanabhan
- Prof. Gayatri Hegde
- Prof. Varunakshi Bhojane

The Student Innovation Ambassador are:

- Rushabh
- Rahul Krishnan
- Vaibhav Anil Gupta
- Arpita Verma

The IIC Calendar Activities are distributed in four quarters. Every quarter comprises IIC Calendar activity, MIC Driven Activity and Self Driven activity. IIC Calendar activity and Self driven activities are planned and conducted by the IIC members for the benefit of its students and faculty members. The various activities organised by the IIC Council are mentioned below.

Quarter I - July to September - Thrust Area: Inspiration, Motivation and Ideation

Ideathon 2020

PCE IIC organized an idea competition “Ideathon 2020” which is an excellent platform to assess the problem-solving abilities as well as technical, management skills, apart from team building, report writing, presentation skills, etc. The competition aimed at aspiring students from secondary and higher secondary schools, as well as students from Diploma and Undergraduate programs in any discipline. As the competition focuses on bringing unique and innovative ideas that would help in bringing control to the pandemic across the world, the competition revolved around 4 themes, which are as follows:

1. PPE (Personal Protective Equipment) and Safety Gear
2. Innovative Idea for Social Distancing
3. Contactless Sanitization and Disinfection
4. Prediction, Modelling, and Simulation to prevent the spread of Covid-19 pandemic



The poster for Ideathon 2020 features the PCE logo and the Pillai College of Engineering name, along with the text 'Mahatma Education Society's Pillai College of Engineering (Accredited A+ by NAAC)'. The main title is 'IDEATHON 2020'. Below this is an illustration of healthcare workers and a student. The central theme is 'HELP THE FRONTLINE WORKERS COMBAT COVID-19 PANDEMIC' with the question 'WHAT'S YOUR IDEA?'. The poster is divided into two columns: 'PARTICIPATION' and 'THEMES'. The 'PARTICIPATION' column lists two categories: Category 1 (Students from Schools and Junior Colleges) and Category 2 (Students from Diploma and Undergraduate courses). The 'THEMES' column lists the four competition themes. Prizes are listed as First Prize 5000, Second Prize 3000, and Third Prize 1500. A 'Submit your ideas' button points to the registration website. The submission deadline is 'On or before 15th June 2020' and the registration fee is 'Rupees 50/-'. Contact information for Prof. Aranya Nijasure is provided. The poster also includes logos of partner organizations like AICTE, TIFR, and the Government of Karnataka, and a QR code for more information.

Participants were divided into two categories:

1. Schools and Junior Colleges students (8th – 12th any discipline)
2. Diploma and Undergraduate College Students (Any discipline)

60+ teams registered for the competition from all over India. The ideas were screened by an esteemed panel of judges and Top 10 teams from each category were shortlisted. The final rounds for the Idea Competition were conducted on 25th and 26th July 2020.

The winners of DPUG category are -

1. DPUG0009- Harsh Agrawal, Aditya Birajdar
2. DPUG0010- Sakshi Raghavendra Kulkarni, Aashirwad Ketan Bedekar, Rujuta Kherdekar
3. DPUG0026- Siddhant Sharma

The winners of SCJR category are -

1. SCJR 0018- Ashwin Rajendra More
2. SCJR0011- Vinay Ramesh Khanija, Dhruv Pramod Sharma, Darshith Arun Shetty
3. SCJR0016- Amrita Amit Mukherjee



The poster for IDEATHON 2020 is yellow with a red header and footer. The header contains the PCE logo, the text 'Mahatma Education Society's Pillai College of Engineering', and the A+ NAAC logo. The main title 'IDEATHON 2020' is in large white letters on a red background. Below the title is a list of five bullet points: 'An Online platform to showcase innovative ideas', 'Participation of more than 60 teams across 2 categories', 'More than 100 participants', 'Team of esteemed panel of Judges', and 'Cash prizes and an experience of a lifetime'. In the center is a screenshot of a Zoom meeting with multiple participants. The footer features a megaphone icon, the text 'RESULTS ANNOUNCED', and the URL 'https://ideathon.pce.ac.in/'.

Quarter II - October to January - Thrust Area: Validation and Concept Development**Webinar on “An overview of IPRs: Importance and Impact of Patent”**

IIC PCE organized a Webinar on “An Overview of IPRs: Importance and Impact of Patents” on 25th November, 2020. The speaker for the session was Dr. T Pavan Kumar who is a Senior Scientist at Institute of Minerals and Materials Technology, Bhubaneswar. IMMT is a CSIR Lab of Government of India. Approximately 50+ faculty and students participated in the webinar.

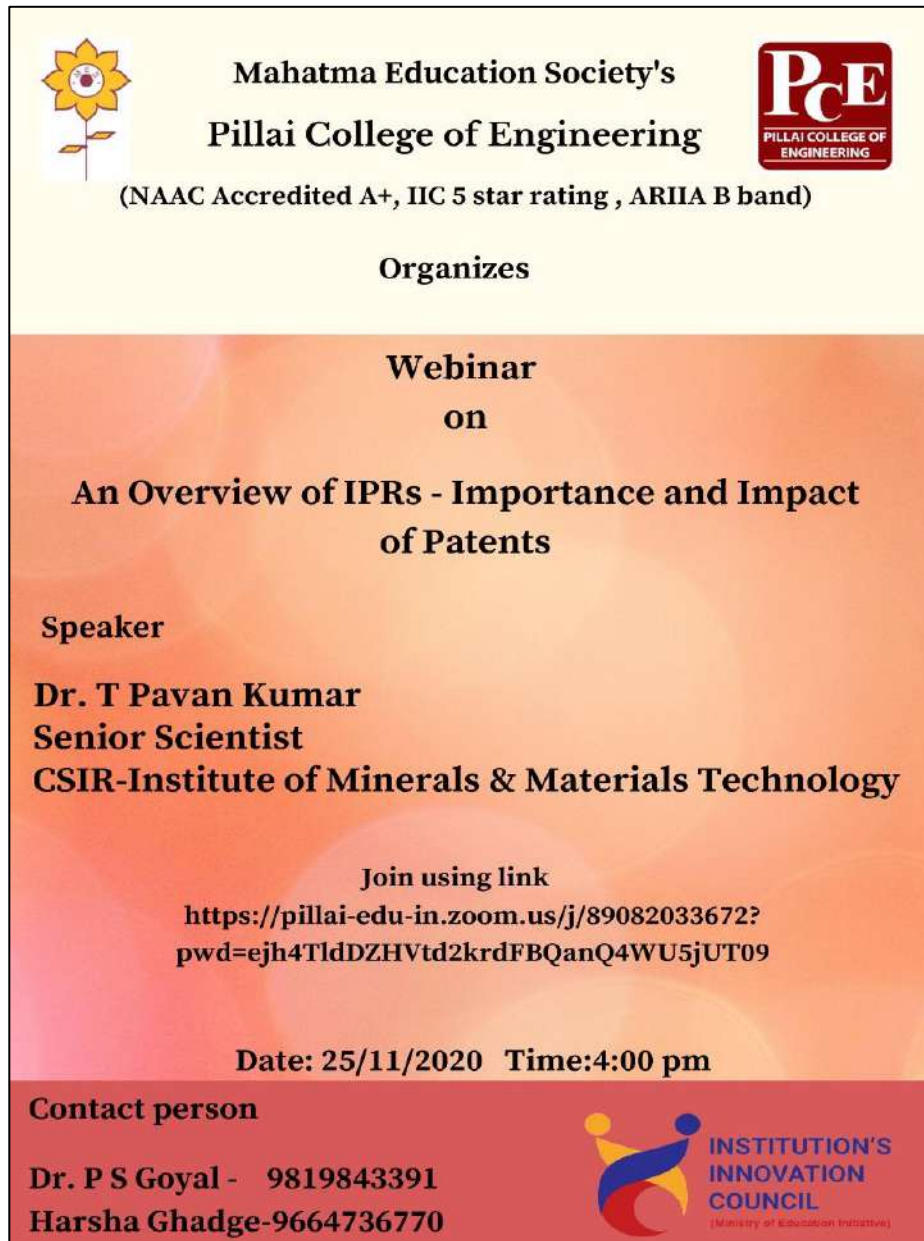

 **Mahatma Education Society's**
Pillai College of Engineering
(NAAC Accredited A+, IIC 5 star rating , ARIIA B band)



Organizes

Webinar
on

An Overview of IPRs - Importance and Impact of Patents

Speaker

Dr. T Pavan Kumar
Senior Scientist
CSIR-Institute of Minerals & Materials Technology

Join using link
<https://pillai-edu-in.zoom.us/j/89082033672?pwd=ejh4TldDZHVtd2krdFBQanQ4WU5jUT09>

Date: 25/11/2020 Time:4:00 pm

Contact person

Dr. P S Goyal - 9819843391
Harsha Ghadge-9664736770

 **INSTITUTION'S INNOVATION COUNCIL**
(Ministry of Education Initiative)

KAPILA

Kalam Program for IP Literacy and Awareness was organised by MoE Innovation Cell from 15th to 23rd October, 2020. The objective of KAPILA was to recognise, facilitate and felicitate the Intellectual Property, innovations and best practices in HEIs. Following IIC members attended these sessions. The Members are:

- Dr. Avinash R. Vaidya
- Dr. Richa Agrawal



Quarter III - February to April - Thrust Area: Prototype, Design, Process Development for Business Model/ Process/ Services

Session on “How to plan for Start-up and legal & Ethical Steps”

IIC and NISP PCE organised a webinar on “How to plan for Start-up and legal & Ethical Steps, How to File Patent in India and Workshop on Prototype/Process Design and Development – Prototyping” on 27th February, 2021. Mr. Dipak Kokane talked about Patent filing in India whereas Mr. Nishant Ravle talked about Prototype/Process Design and Development – Prototyping.

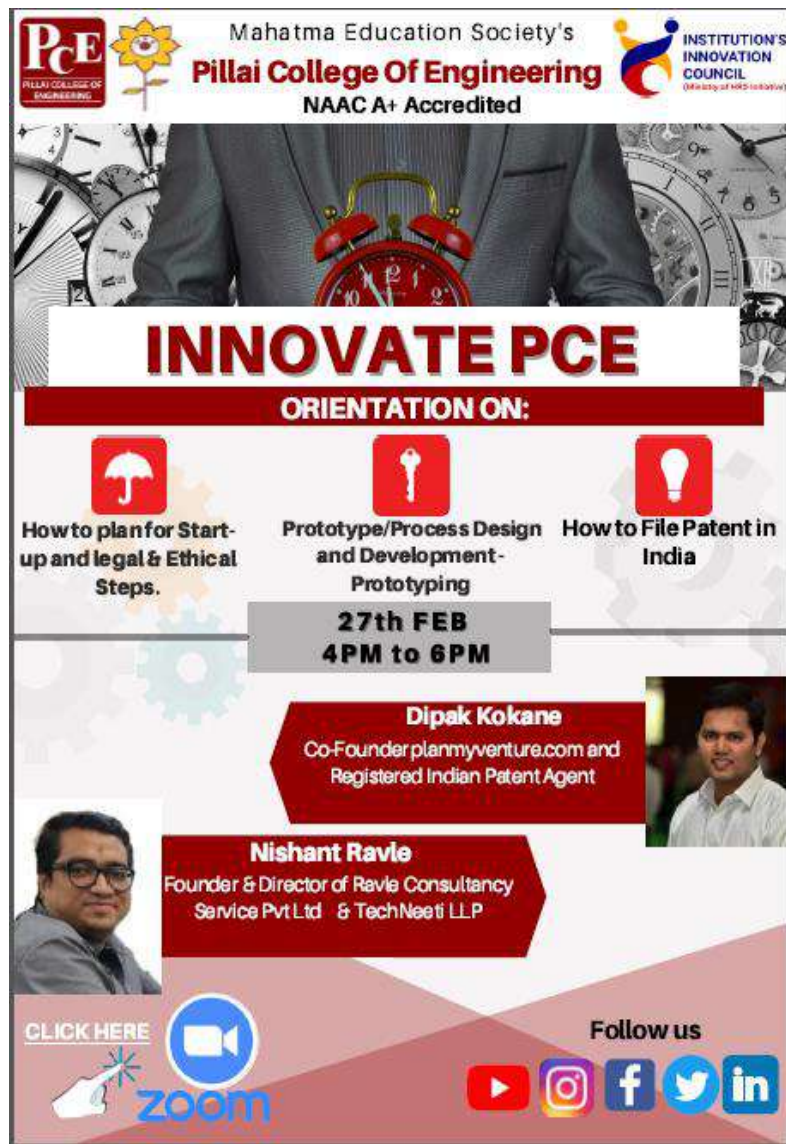

The poster features the PCE logo and Pillai College of Engineering name at the top, along with NAAC A+ Accredited status and logos for Mahatma Education Society's and the Institution's Innovation Council. The central theme is 'INNOVATE PCE' with an orientation on three topics: 'How to plan for Start-up and legal & Ethical Steps', 'Prototype/Process Design and Development- Prototyping', and 'How to File Patent in India'. The event is scheduled for 27th FEB from 4PM to 6PM. Two speakers are highlighted: Dipak Kokane, Co-Founder of planmyventure.com and a Registered Indian Patent Agent, and Nishant Ravle, Founder & Director of Ravle Consultancy Service Pvt Ltd & TechNeeti LLP. The poster also includes a Zoom link and social media icons for YouTube, Instagram, Facebook, Twitter, and LinkedIn.

Orientation session for all students & faculties of Institute by Innovation Ambassador(s)

IIC PCE organised an Orientation session for all students & faculties of Institute by Innovation Ambassadors Dr. Divya Padmanabhan and Prof. Varunakshi Bhojane on 2nd March, 2021. The event started with the welcoming and introduction of two speakers. First talk was given by Dr. Divya Padmanabhan on Innovation and Invention. She clearly explained about the difference between the two and what it really matters to be a successful innovator. The talk was very interesting and motivational for the students. The second talk was given by Prof. Varunakshi Bhojane on Design thinking. It emphasized on how these stages work and how designers can use it to organize their thoughts in order to improve the creative process. It was too a wonderful talk. Such sessions really motivate students to think differently and go ahead with their ideas.



The poster features the PCE logo and Pillai College of Engineering name at the top, along with NAAC A+ Accredited and Institution's Innovation Council logos. The main title 'INNOVATE PCE' is prominently displayed in blue, followed by 'ORIENTATION ON INNOVATION AND INVENTION' in red. The date and time '2nd March, 2021, 4.00 to 5.00 pm' are listed below. Two speakers are featured: Dr. Divya Padmanabhan and Prof. Varunakshi Bhojane, both Innovation Ambassadors at PCE. At the bottom, there is a 'CLICK TO JOIN' button with a Zoom icon and social media icons for YouTube, Instagram, LinkedIn, Facebook, and Twitter.

Mentorship Session for Innovators (or) Student Entrepreneurs through experts and (or) Innovation Ambassadors/Innovation Agent

IIC PCE organised an Mentoring Session for Innovators through Innovation Ambassadors Prof. Gayatri Hegde and Prof. Harsha Ghadge on 26th March, 2021. First talk was given by Prof. Gayatri Hegde on Entrepreneurship and explained about the success stories of young entrepreneurs. The talk was very interesting and motivational for the students. It highlighted the path taken by successful entrepreneurs. The second talk was given by Prof. Harsha Ghadge on Creativity, Innovation and Entrepreneurship. The talk focused on how these three parameters are related. It was too a wonderful session concluding again with the success stories of Indian entrepreneurs. Such sessions really motivate students to think differently and go ahead with their ideas.



The image shows a Zoom meeting invitation for a mentorship session. At the top, it features the logos of Pillai College of Engineering (PCE) and the Institution's Innovation Council (IIC). The text identifies the event as 'Mahatma Education Society's Pillai College of Engineering (NAAC A+ Accredited, 5 Star IIC)'. The main title is 'INNOVATE PCE', scheduled for '26th March 2021' from '4:00- 5:00 pm'. Below this, a green banner reads 'Mentorship Session for Innovators through Innovation Ambassadors'. The speakers listed are Prof. Gayatri Hegde and Prof. Harsha Ghadge, both Innovation Ambassadors at PCE. At the bottom, there is a 'Click to join' link and the Zoom logo.

  Mahatma Education Society's
Pillai College of Engineering
(NAAC A+ Accredited, 5 Star IIC)  INSTITUTION'S
INNOVATION
COUNCIL

INNOVATE PCE

26th March 2021
4:00- 5:00 pm

**Mentorship Session for Innovators
through Innovation Ambassadors**

Speakers
Prof. Gayatri Hegde
Innovation Ambassador, PCE

Prof. Harsha Ghadge
Innovation Ambassador, PCE

Click to join

Quarter IV - May to July - Thrust Area: Awareness about Startup and related Ecosystem

Session on Prototype Validation - Converting Prototype into a Start-up

IIC and NISP PCE organised a webinar on “Prototype Validation - Converting Prototype into a Start-up” on 24th April, 2021 The speaker for the webinar was Mr. Nishant Ravle, Founder & Director of Ravle Consultancy Services Pvt Ltd & TechNeeti LLP.

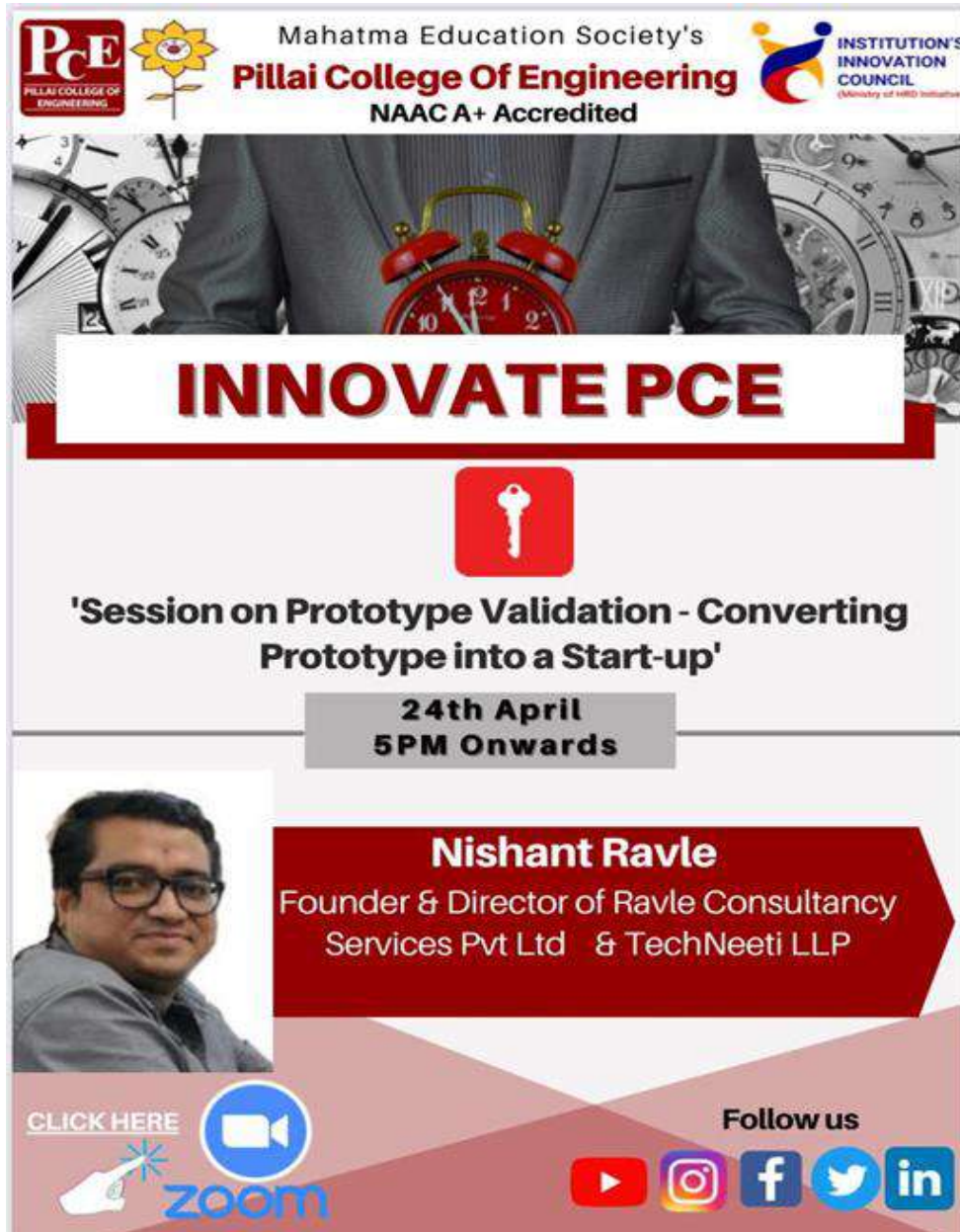

PCE Mahatma Education Society's
Pillai College Of Engineering
NAAC A+ Accredited

INSTITUTE'S INNOVATION COUNCIL
(Ministry of HRD Industries)





INNOVATE PCE

'Session on Prototype Validation - Converting Prototype into a Start-up'

24th April
5PM Onwards

Nishant Ravle
Founder & Director of Ravle Consultancy
Services Pvt Ltd & TechNeeti LLP

CLICK HERE 
zoom

Follow us     

Webinar on “Nurturing Clean, Green, and Lean Mindset for the Sustainable Future”

IIC and NISP PCE organised a webinar on “Nurturing Clean, Green, and Lean Mindset for the Sustainable Future ” on 29th May, 2021. The speaker for the webinar was Dr. Deepak Waikar, Managing Partner, EduEnergy, Singapore. Dr. Waikar talked about the importance of working towards a clean, green and sustainable environment in the future.



Mahatma Education Society's
Pillai College of Engineering
(NAAC A+ Accredited, 5 Star IIC, ARIIA Band B)

INNOVATE PCE
NURTURING CLEAN, GREEN AND LEAN
MINDSET FOR THE SUSTAINABLE FUTURE

29th May, 2021, 11.00 am

 **Dr. Deepak Waikar**
EduEnergy, Singapore

CLICK TO JOIN
CLICK TO REGISTER



Follow us



Student Chapter Activities

CSI



Sr. No.	Name of Activity	Date	Organizer	Speaker
1	Webinar on Introduction to Data science	1 st July, 2020	CSI PCE	Ms.Nidhi Menon, Alumni Dept of Computer Engineering
2	Coder of the Semester - Season 2	1 st July, 2020	CSI PCE	Prof. Dhiraj Amin, Mr. Akshay Saved
3	Webinar on Fundamentals of C programming	18 th July, 2020	CSI PCE	Prof. Ranjita Gaonkar
4	Webinar on "Product Management Vs Project Management".	25 th July, 2020	CSI PCE	Mr. Fenil Dedhia ,Alumni of Department of Computer Engineering of outgoing batch 2012-13
5	Webinar on "Professional Industrial Resume".	1 st August 2020	CSI PCE	Ms.Swetha Ramaswamy Alumni of Department of Computer Engineering of outgoing batch 2016-17
6	Session on " Hack-a-talk " by finalists of Smart India Hackathon (SIH)	16 th August 2020	CSI PCE	ALL SIH 2020 and mh participants
7	Webinar on Project Deep Blue by Mastek and Majesco's	21 st August, Friday	Computer Engineering &	Mr. Akhil Singhal,



			Information Technology	
8	Deep Blue Webinar on "Writing Effective Abstract Webinar"	20 th September 2020	CSI PCE	Mr. Harshall Lamba
9	Industry Expert talk on "IOS application Development"	27 th September 2020	CSI PCE	Mr. Rahul Pinjani Alumni of Department of Computer Engineering of outgoing batch 2010-11
10	Study Circle on front-end web development using Bootstrap4 and AlpineJS Framework	7 th and 09 th October, 2020	CSI PCE	Mr. aditya Nair and Mr. Akshay Saved
11	Webinar on Foundations of Natural language Processing	27 th March, 2021	CSI PCE	Mrs. Kritika Rupauliha
12	Webinar on KOTLIN and FIREBASE essentials : Build a multilayer Quiz App	27 th and 28 th March, 2021	CSI PCE	Mr. Mubin Ansari from SE-Computer Engineering, Mr. Yash Paddalwar and Mr. Sonu Mondal from SE-Information Technology
13	Engineering 101: Tackling Engineering in the right way	4 th April, 2021	CSI PCE	Ms. Saloni Gharge (Content Manager), Ms. Vaishnavi Garad (TE Computer Engineering Representative), Ms. Sukrishna Nair (Jt. Publicity Head) and Mr. MK Varun Viswanathan (Vice Chairperson) from TE-Computer Engineering & Mr. Aakash Patil (SE-Information Technology).
14	Battle of Wits	4 th April, 2021	CSI PCE	Ms. Rutuja Jadhav (Jt. Treasurer) and Mr. Harish Nilare (SE Computer Engineering).

Webinar on Introduction to Data science

Date: 1st July 2020

Introduction to Data Science was a webinar organized by CSI-PCE student branch on 1st July 2020. The session was conducted by Ms. Nidhi Menon, an alumna of Pillai College of Engineering who is associated with Autodesk, USA. Google Meet was used as the platform for conducting the event. The webinar gave useful insights in the field of Data Science. In addition, real-world examples were given to aid better comprehension of Data Science, which is the fastest growing domain in the current era. At the end of the webinar, students were able to understand the importance of Data Science. It was an interactive session between the students and the speaker. The webinar was attended by 154 students and 19 faculty members.

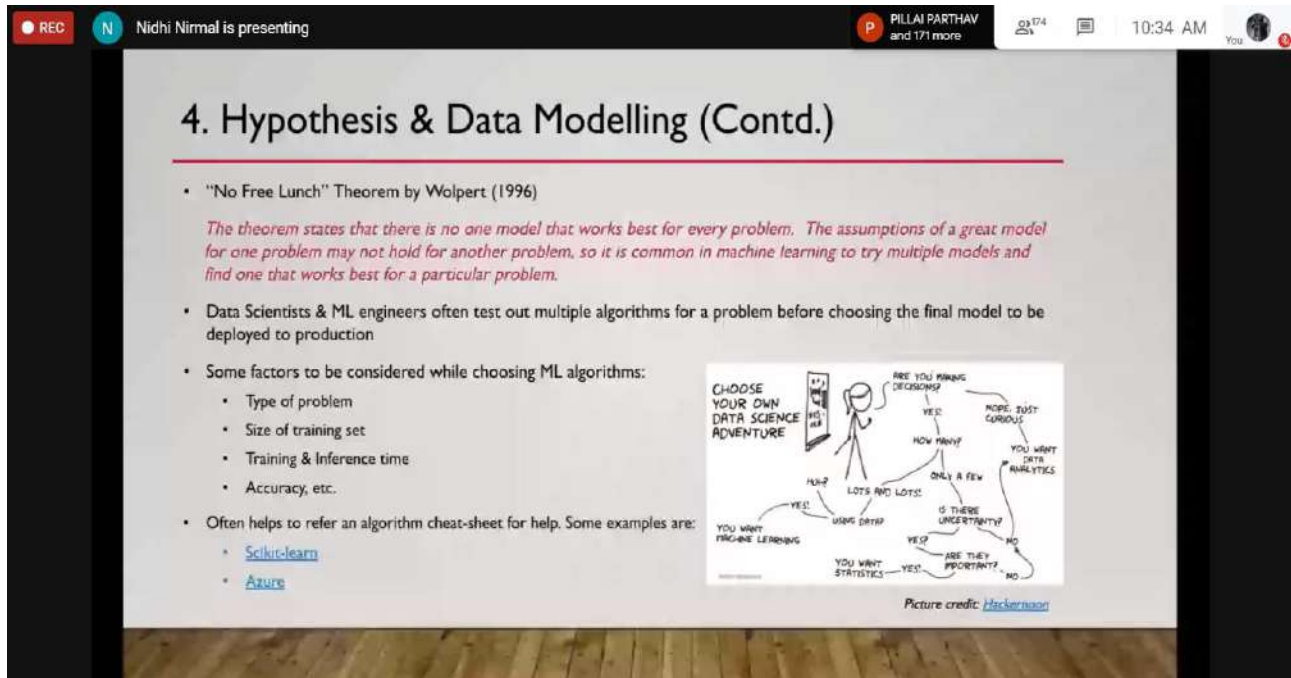

The screenshot shows a Google Meet interface with a presentation slide. The slide title is "4. Hypothesis & Data Modelling (Contd.)". It contains the following text:

- "No Free Lunch" Theorem by Wolpert (1996)
The theorem states that there is no one model that works best for every problem. The assumptions of a great model for one problem may not hold for another problem, so it is common in machine learning to try multiple models and find one that works best for a particular problem.
- Data Scientists & ML engineers often test out multiple algorithms for a problem before choosing the final model to be deployed to production
- Some factors to be considered while choosing ML algorithms:
 - Type of problem
 - Size of training set
 - Training & Inference time
 - Accuracy, etc.
- Often helps to refer an algorithm cheat-sheet for help. Some examples are:
 - [Scikit-learn](#)
 - [Azure](#)

On the right side of the slide, there is a hand-drawn flowchart titled "CHOOSE YOUR OWN DATA SCIENCE ADVENTURE". The flowchart starts with a stick figure holding a smartphone. It asks "ARE YOU MAKING DECISIONS?". If "NOPE, JUST CURIOUS", it leads to "YOU WANT DATA ANALYTICS". If "YES!", it asks "HOW MANY?". If "ONLY A FEW", it leads to "IS THERE UNCERTAINTY?". If "NO", it asks "ARE THEY PRIORITY?". If "YES!", it leads to "YOU WANT STATISTICS". If "NO", it leads to "YOU WANT MACHINE LEARNING". If "LOTS AND LOTS", it asks "DO YOU WANT DATA?". If "YES!", it leads to "YOU WANT MACHINE LEARNING". If "NOPE", it leads to "YOU WANT DATA ANALYTICS".

Picture credit: [Hackerrank](#)

Coder of the Semester - Season 2

Date: 1st July /2020

Pillai College of Engineering in association with CSI-PCE, conducted the second season of Coder of the Semester. It is an initiative to help students improve their programming skills. The second season was conducted for students of all branches in two levels. Level-1 of Coder of the Semester is for F.E. students exclusively, whereas Level-2 of Coder of the Semester is for S.E., T.E. and B.E. students. More than 150 students participated in the competitions and displayed great results. The competition was divided into 2 rounds. The first round was an objective round which took place on 21st March 2020. The final round was the programming round which was conducted on the Hackerrank portal and took place on 1st July 2020 and winners of the competition are:

Coder of the Semester - Season 2	
Level-1 - F.E.	Level-2 - S.E., T.E., B.E.
Anuj Joshi	Aditya Sivaram Nair (S.E. Comps)
Aakash Vishwakarma	Anant Vishwakarma (S.E. Comps)
Kartik Chauhan	Aditya Mhatre (T.E. Comps)

Webinar on Fundamentals of C programming

Date: 18th July 2020

A webinar on Fundamentals of C Programming was organized by CSI-PCE student branch for students of Pillai College of Engineering and Pillai HOC College of Engineering on 18th July 2020. The session was conducted by Prof. Ranjita N. Gaonkar, a faculty member of Pillai College of Engineering. The webinar covered basics of C Programming Language which are data types, variables, arrays, function, pointers, and structures. By the end of the webinar, students understood the fundamentals of C programming. It was an interactive session between the speaker and the students. The webinar was conducted on the Google Meet platform. The webinar was attended by 270 students, hence was conducted on 2 meets simultaneously.

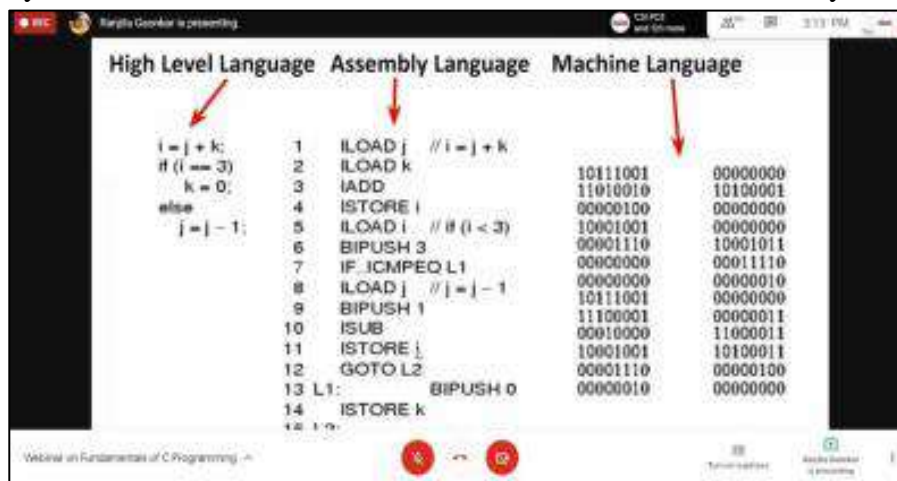

Webinar on "Product Management Vs Project Management"

Date: 25th July, 2020

CSI-PCE student branch organized a webinar on Product Management vs Project Management on 25th July 2020 over the Google Meet platform. The session was conducted by Mr. Fenil Dedhia, an alumnus of Pillai College of Engineering, associated with Agolo, USA as a Product Manager. The webinar helped students explore a new domain with potential career objectives and covered various topics related to Product Management, Project Management and the difference

between the both. The speaker highlighted the importance of Product and Project Management, along with the certifications required and job opportunities. The webinar was attended by 150 students and 8 faculty members.

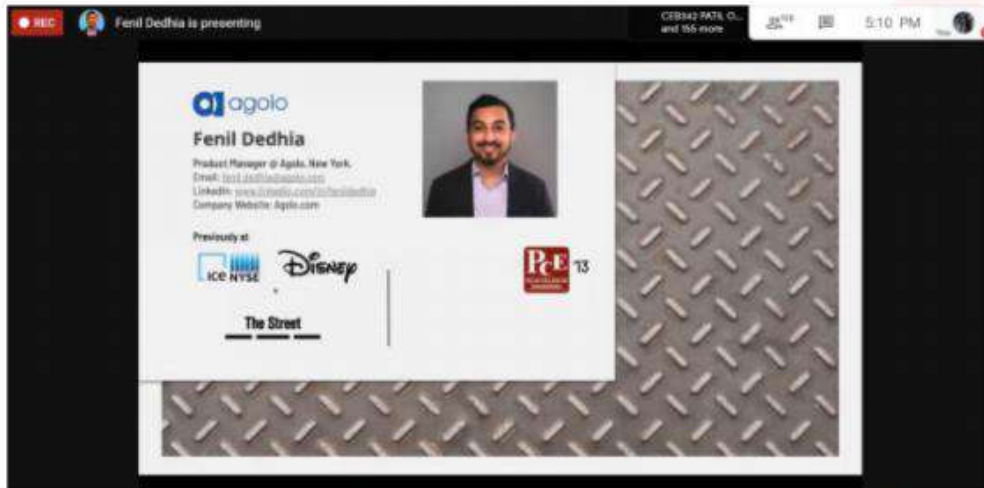

Webinar on "Professional Industrial Resume"

Date: 2nd August 2020

Professional Industrial Resume was a webinar conducted by CSI-PCE student branch on 2nd August 2020 over the Google Meet Platform. The session was conducted by Ms. Swetha Ramaswamy, an alumna of Pillai College of Engineering, associated with Amazon, USA as a Software Development Engineer. The webinar helped create an awareness among students about the importance of creating a short and effective resume, and how hackathons and internships improve a resume. The speaker also gave key insights on the upcoming trends and domains in the IT industry. It was an interactive session between the speaker and the participants. The webinar was attended by 155 students.

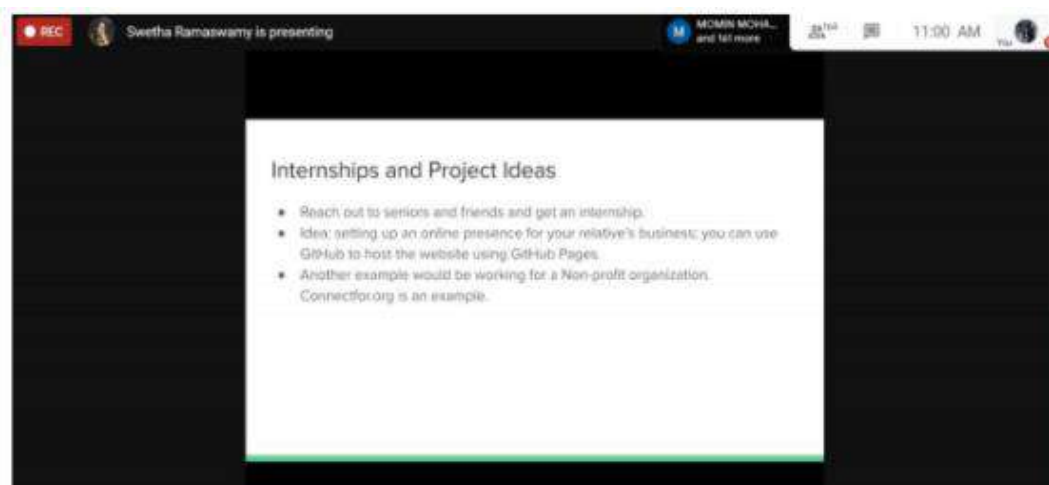

Session on “Hack-a-talk” by finalists of Smart India Hackathon (SIH)

Date: 16th August 2020

CSI-PCE student branch organized a Hack-a-Talk session on 16th August 2020 over the Google Meet Platform. The session was conducted by the finalist teams of Smart India Hackathon 2020 - Software Edition. The teams who conducted the session are:

1. Team Codeblooded.io
2. Team Sattva
3. Team Code_Crunch
4. Team Status200
5. Team CipherCops

The talk session helped in making students aware of the importance of participating in hackathons and its various benefits and qualities that get cultivated when we take part in competitions. Each team had a brief talk session of 10-15 minutes where they covered various topics which included defining and identifying the problem statements, forming teams, understanding the errors, learning some moral values of never giving up in spite of things not going the right way. It was an interactive session between the teams and the participants. The talk session was attended by 149 students.

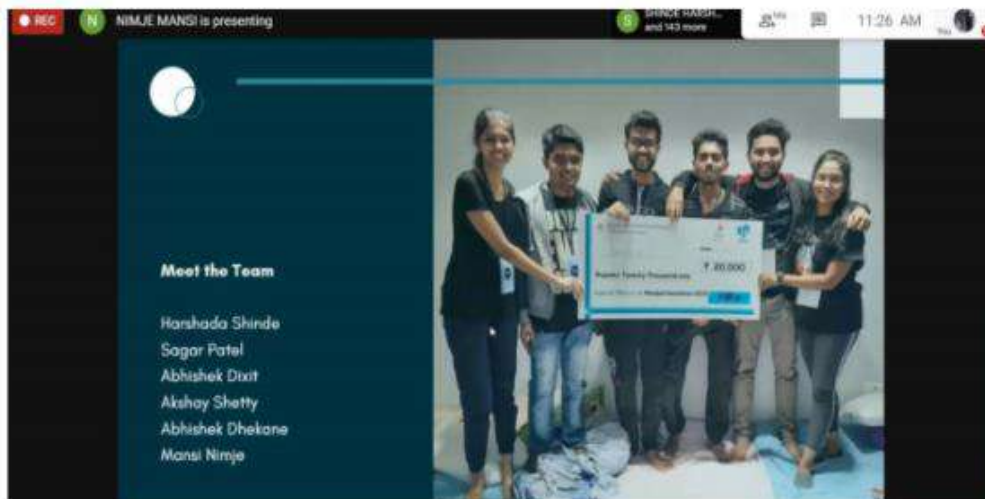

Webinar on Project Deep Blue by Mastek and Majesco's

Date: 21st August 2020

Pillai College of Engineering in association with CSI-PCE organized a Deep Blue Competition orientation program for students on 21st August 2020 over Google Meet Platform. The session was conducted by Mr. Akhil Singhal, who is associated with Mastek as the Deep Blue coordinator and Data Scientist. The webinar gave an introduction about the Deep Blue Competition to students. The speaker highlighted the problem statement for the 6th season of the competition and important deadlines for registration and abstract submission. After the speaker's

session, teams from previous seasons spoke about their experiences of Deep Blue encouraging students to participate in the competition. The orientation was an interactive session between the speaker, teams and the participants. The webinar was attended by 160 students.



Deep Blue Webinar on “Writing Effective Abstract Webinar”

Date: 20th September 2020

Pillai College of Engineering in association with CSI-PCE organized a webinar on Writing Effective Abstracts for Deep Blue participants on 20th September 2020 over the Google Meet Platform. The session was conducted by Mr. Harshall Lamba, who is associated with Vidooly media tech as a Data Scientist. The webinar focused on the creation of an abstract, through identification of the problem statement and doing a thorough research before forming an abstract. After the speaker’s session, students from previous seasons gave useful insights on drafting effective abstracts. The webinar was an interactive session between the speakers and the participants. The webinar was attended by 110 students.

Industry Expert talk on "IOS application Development"

Date: 27/09/2020

A webinar on iOS Application Development was organized by CSI-PCE student branch on 27th September 2020, over Google Meet Platform. The session was conducted by Mr. Rahul Pinjani, an alumnus of Pillai College of Engineering associated with Hilton, USA as a Senior iOS Engineer. The webinar gave a basic understanding of the iOS ecosystem to participants. The speaker gave useful insights on the increasing demand for reliable iOS application developers in the global market, interviewing aspects and management strategies of iOS Application Development. Addition to this, Mr. Rahul Pinjani gave a live demo as to how Swift Programming is used for the development of iOS applications. The webinar was attended by 166 students and 4 faculty members.

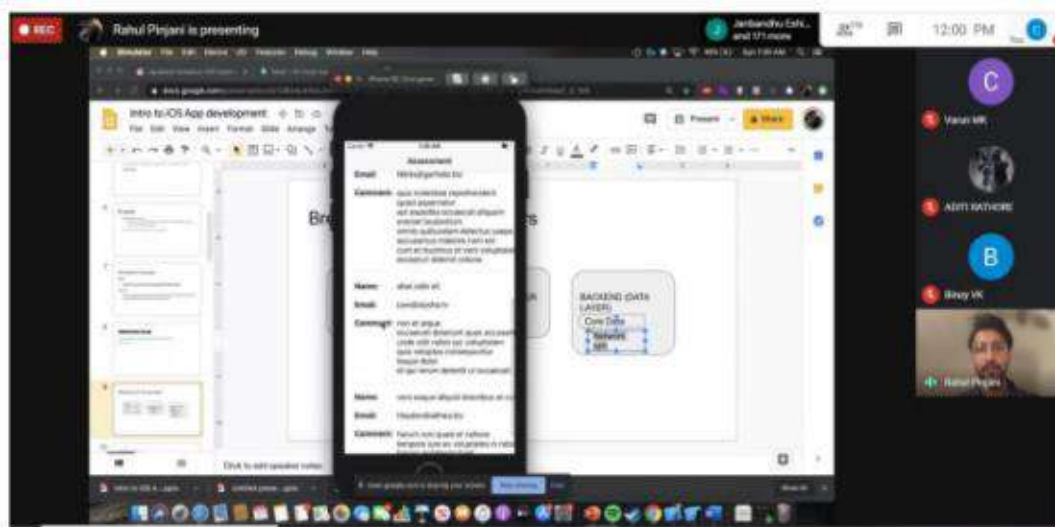

Study Circle on front-end Web Development using Bootstrap4 and AlpineJS Framework

Date: 7th Oct 2020 and 09th Oct 2020

Responsive Web Designing Study Circle was organized by the CSI-PCE student branch exclusively for its members on 7th and 9th October over Google Meet Platform. The event was conducted by Mr. Aditya Nair (Jt. Coder's Club Head) from T.E. Computer Engineering and Mr. Akshay Savad (Jt. Technical Head) from T.E. I.T. in the form of a guided project. The study circle covered various topics in web development which includes main aspects of building, designing, and functioning of websites or web applications by writing markup text and coding through the use of Bootstrap4 and Alpine.js Framework. By the end of the study circle, students were able to complete their projects successfully. The study circle helped students to implement their projects in PBL and it was attended by 40 students.

Session 1:



Webinar on Foundations of Natural language Processing

Date: 27th March 2021

A webinar on Foundations of NLP was organized by CSI-PCE student branch on 27th March 2021 over the Zoom Platform. The session was conducted by Ms. Kritika Rupauliha, pursuing her Bachelors in Engineering from ITM University, Gwalior who has been a software engineer Intern at Microsoft, Cognecto and ML Engineer at Omdena. The webinar focused on the fundamental understanding of NLP, technicalities present in the topic and how to use them effectively. Addition to this, Ms. Kritika Rupauliha explained a project which helped students to understand the real-life applications of Natural Language Processing. The webinar was an interactive session between the speaker and the students and it was attended by 100 participants.

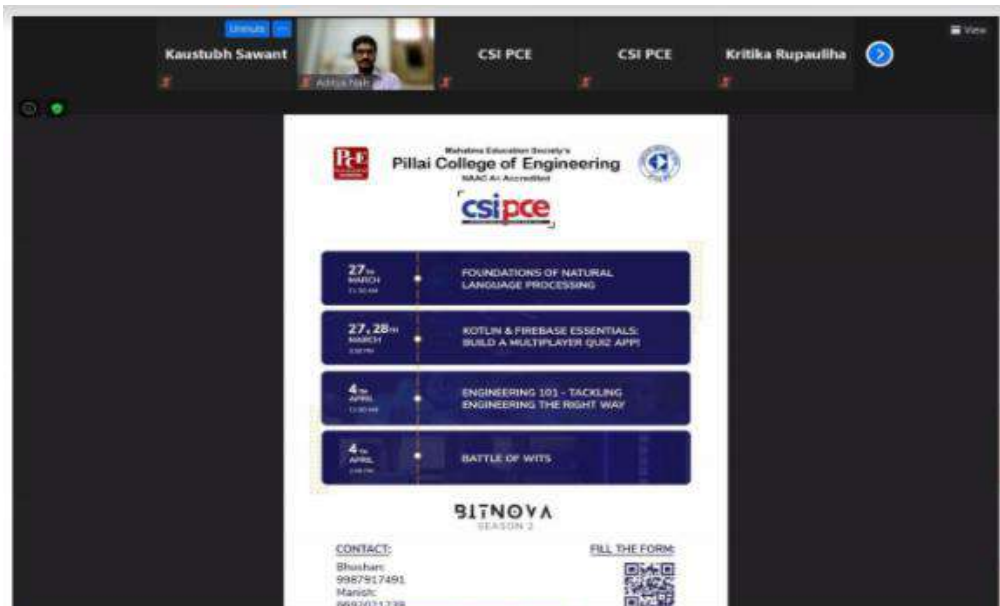

Webinar on KOTLIN and FIREBASE Essentials: Build a Multilayer Quiz App

Date: 27th March 2021 and 28th March 2021

CSI-PCE student branch organized a study circle on Kotlin & Firebase Essentials exclusively for its members on 27th and 29th March respectively over the Google Meet Platform. The event was conducted by students from our college, Mr. Mubin Ansari from S.E. Computer Engineering, Mr. Yash Paddalwar and Mr. Sonu Mondal from S.E. I.T. over a live project. The study circle helped students explore the Android Studio platform which was used to create the application. The speakers covered topics like setting up the correct environment for application development, along with designing concepts for the front-end and logical concepts for the back-end respectively. By the end of the study circle students were able to create their own applications. The study circle was an interactive session between the students and the speakers and it was attended by 40 students.

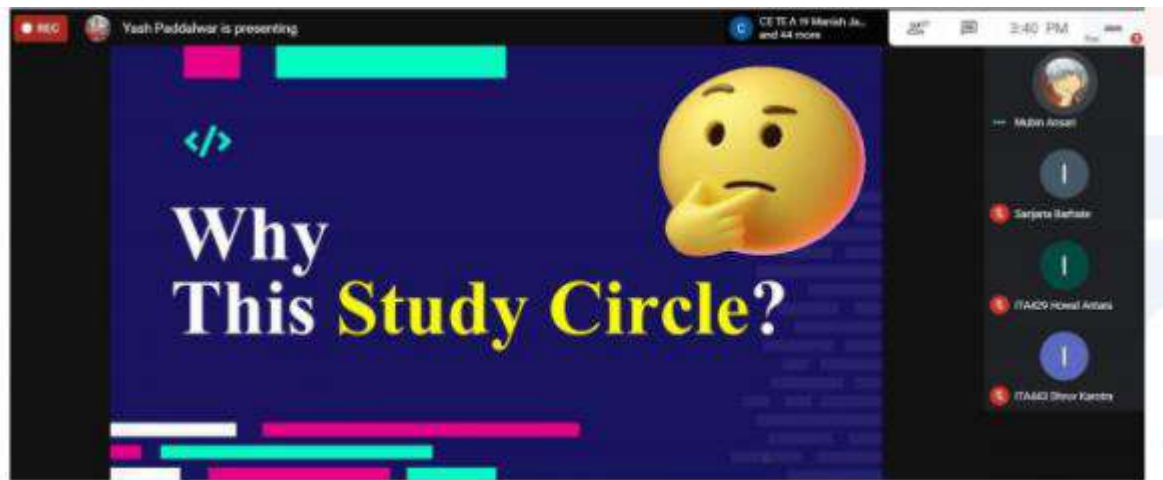

Engineering 101: Tackling Engineering in the right way



Date: 04th April 2021

Engineering 101 - Tackling Engineering the Right Way was a talk session organized by the CSI-PCE student branch exclusively for F.E. students on 4th February 2021 over the Google Meet Platform. The event was conducted by students of our college, Ms. Saloni Gharge (Content Manager), Ms. Vaishnavi Garad (T.E. Computer Engineering Representative), Ms. Sukrishna Nair (Jt. Publicity Head), Mr. MK Varun Viswanathan (Vice Chairperson) from T.E. Computer Engineering and Mr. Aakash Patil from S.E. I.T. respectively. The webinar was conducted to guide and mentor the F.E. students through the perspective of S.E. and T.E. students, and help them to understand the ways to break through the initial layers of engineering. The talk session was interactive between the students and the participants and was attended by 70 students.

Battle of Wits

Date: 04th April 2021

CSI-PCE student branch organized a fun event Battle of Wits exclusively for F.E. students on 4th April 2021 over the Google Meet Platform. The event was aimed for students to showcase their skills and compete with others to find the best. The event was a combination of engaging and intriguing activities and challenges comprising various rounds, testing their problem- solving skills and quick wit. The event was divided into 3 rounds. The three rounds were as follows:

1. Quiz and Buzzer Battle
2. Combination of Technical and Non-Technical Events
 - a. Technical Events - Guess the Output, Spot the error, and Shortcut keys
 - b. Non-Technical Events - Guess song based on its tune, Identify the movie based on the given dialogue, Guess the cartoon from the given image, Identify the name of the place from a given set of icons, and Guess the Icon
3. Word Document consisting of tasks based on coordinates of the map from Google with a time limit of 30 minutes.

The enthusiasm with which the students participated was commendable and much appreciated. The winners of the competition were

- Gaurav Sawant
- Akhil PP Mohandas
- Tanishq Parka

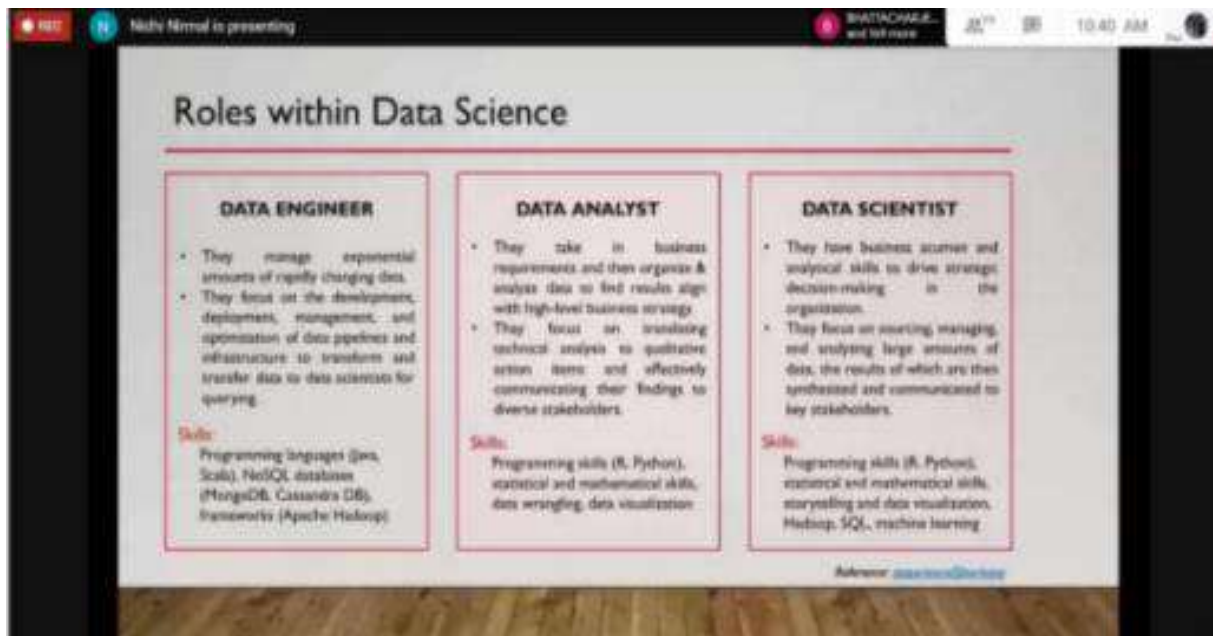



AESA-MESA



Sr No	Event Name	Date
1	Trivia Quest	16 th August, 2020
2	Engineers Day	15 th September, 2020
3	Webinar on Industrial Automation	8 th November, 2020
4	Webinar on Engine Design	20 th March, 2021



Trivia Quest

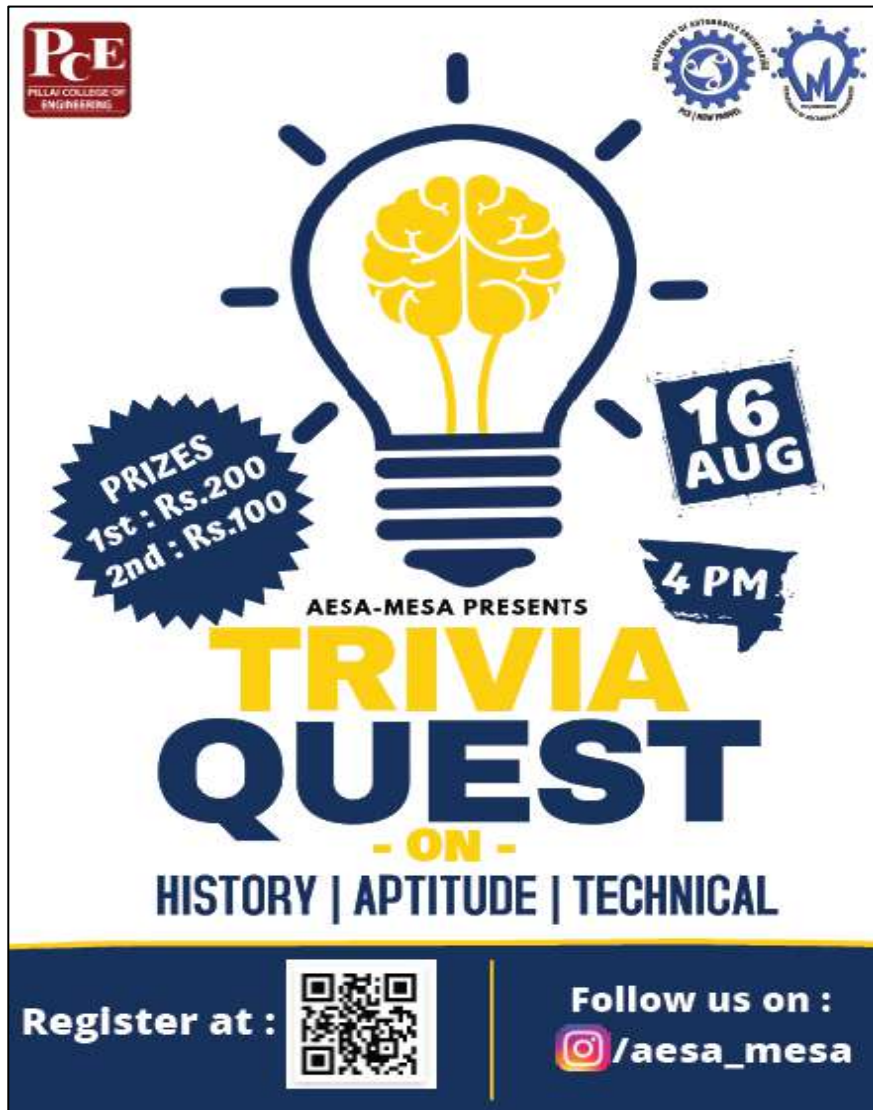

AESA MESA successfully conducted the Trivia Quest 2020 for second year students of automobile and mechanical engineering on 16th August 2020. The competition consisted of three rounds. First round had 20 questions based on the Indian History time, Second round was based on the Technical Aptitude and then the final round.

Engineers Day Celebration

AESA-MESA celebrated Engineers day in collaboration with ISHRAE ON 15th September, 2020 via Google Meet. The event had two segments. The first session one was a talk by Prof. A. Shaligram on refrigeration industry and its future scope and Prof. Manikant Verma on how to bridge the gap between syllabus and industrial education. The second session was an open discussion on some general topics.



PCE PILLAI COLLEGE OF ENGINEERING
Dr. K. M. Vasudevan Pillai Campus, Plot No. 10, Sector 10, New Panvel East,
Navi Mumbai, Maharashtra 410206.

50
A+
NAAC

DEPARTMENT OF AUTOMOBILE AND
MECHANICAL ENGINEERING
CELEBRATES ...

ENGINEER'S DAY 2020

IN ASSOCIATION WITH

  **ISHRAE**
PCE Chapter

AESA-MESA and ISHRAE

Join us for the Talks and Open
Discussion.

15 Sept. 2020 5:00 PM

Join via Meet:
<https://meet.google.com/dqv-xxlyv-zcn>



M. Visvesvaraya

The Engineering Community across India celebrates Engineers Day on 15 September every year as a tribute to the greatest Indian Engineer Bharat Ratna Mokshagundam Visvesvaraya.



Motivational Talk

AESA-MESA successfully conducted a Motivational interactive session with students of 2nd, 3rd and 4th year students on 20th September 2020. The speaker for the session was Mrs. Chitra Pillai, Author and Success Coach. The event started with students expressing their problems and what outcome they expected from the event. Madam explained about three mental zones i.e. Fear zone, learning zone and growth zone and talked on how to expand and add value to others' lives. It brought clarity of thoughts in the participants on how to approach their problems in life and cut out negativity. Truly the “Let’s talk” event was very interactive where students talked about their problems and then were amazed to find the solution of their problems within themselves.



PCE
PILLAI COLLEGE OF
ENGINEERING

AESA MESA PRESENTS

LET'S TALK...

Coping up with our emotional state of mind in the current scenario is really a huge challenge for many of us.

Join us for the interactive session to raise your emotional intelligence and empower yourself to handle these challenges effectively during this difficult time.

Mrs. Chitra Pillai
AUTHOR, SUCCESS COACH
AND NLP TRAINER

20 Sept. 2020
4:00 to 5:00 PM

REGISTER AT:



CONTACT US:
GOKUL: 8422935355
MAYUR: 8390647214

 /AESA_MESA

Webinar on Industrial Automation

AESA-MESA successfully conducted a webinar on Industrial Automation on 8th November 2020. The expert for the webinar was Mr. Joy Eapen, PCE alumni, currently an Industrial Automation engineer at Consulta technologies Pvt. Ltd. He discussed about Factory Automation, Process Automation, various components used in automation, Machine Vision, features of PLC and Skada automation software.

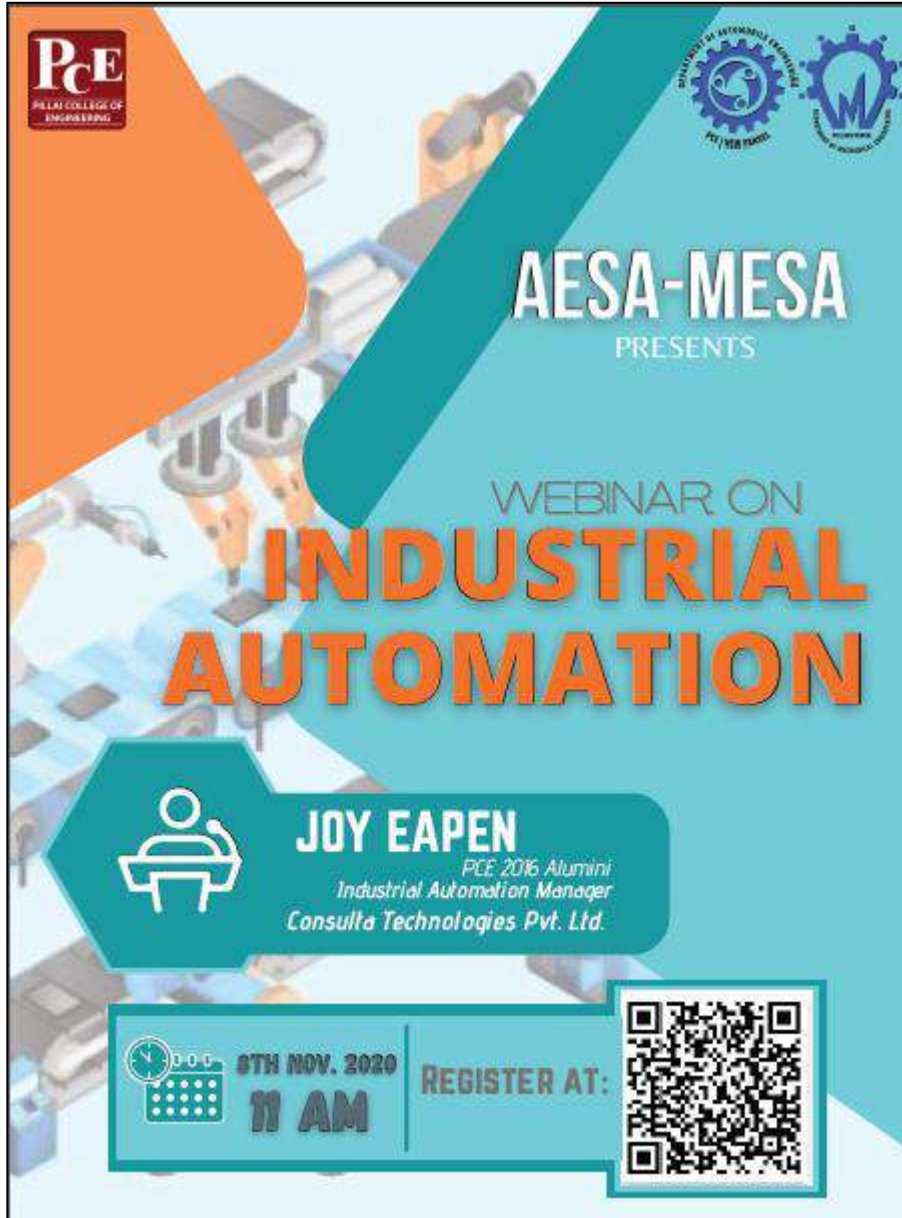

The poster features a background of industrial machinery. In the top left corner is the PCE logo. In the top right corner are two circular logos: one for AESA (Association of Engineering Students of Anna University) and one for MESA (Murali Engineering Students Association). The main text reads 'AESA-MESA PRESENTS WEBINAR ON INDUSTRIAL AUTOMATION'. Below this, a teal box contains an icon of a person at a desk, followed by the name 'JOY EAPEN', his title 'PCE 2016 Alumni Industrial Automation Manager', and his company 'Consulta Technologies Pvt. Ltd.'. At the bottom left, a calendar icon indicates the date '8TH NOV. 2020' and time '11 AM'. To the right of this is the text 'REGISTER AT:' followed by a QR code.

Webinar on Engine Design

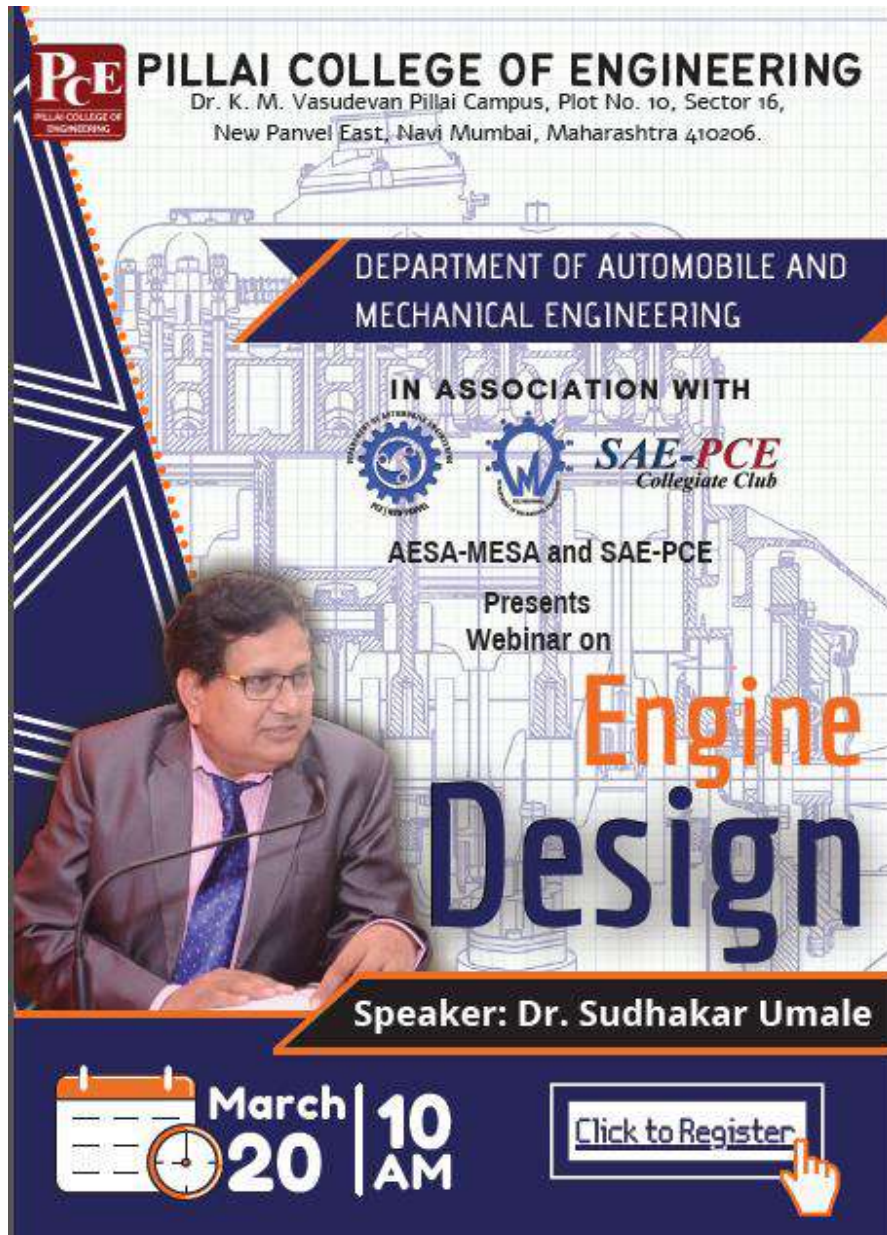

A webinar on “ENGINE DESIGN” was organised on 20th March, 2021. The speaker for the session was Dr Sudhakar Umale, Head and Associate Professor, Mechanical Engineering Department, Sardar Patel College of Engineering. He spoke about the need and importance of designing engines with new technologies, problems with the current engines like high engine noise and vibrations, engine cooling problems, engine emissions etc. and also explained the solutions to those problems. He also discussed on factors to be considered during design of IC Engines, types of fluids used in IC Engines, selection of fuels. This led the discussion to the importance of BS VI technology.



PCE PILLAI COLLEGE OF ENGINEERING
Dr. K. M. Vasudevan Pillai Campus, Plot No. 10, Sector 16,
New Panvel East, Navi Mumbai, Maharashtra 410206.

DEPARTMENT OF AUTOMOBILE AND
MECHANICAL ENGINEERING

IN ASSOCIATION WITH

  **SAE-PCE**
Collegiate Club

AESA-MESA and SAE-PCE
Presents
Webinar on

**Engine
Design**

Speaker: Dr. Sudhakar Umale

 March 20 | 10 AM

[Click to Register](#) 



ISHRAE



Sr No	Event Name	Date
1	K-12 DPGA, Panvel	05-02-2021
2	Online K-12	24-12-2020
3	Squibble Solidworks competition	14-11-2020
4	K12 Balagram Orphanage	07-11-2020
5	Solidworks BootCamp	14-09-2020
6	ISHRAE PCE Installation Ceremony	07-08-2020



K-12 DPGA, Panvel

ISHRAE PCE Chapter in collaboration with ISHRAE Thane Chapter organized a K12 activity for 1st & 2nd standard school students of Dr. Pillai Global Academy (Panvel). The topics covered during the event were Experiments on Thermodynamics and Concept of Sustainable Development followed by a doubt solving session related to topics covered.

ISHRAE Thane Chapter

40 YEARS OF ISHRAE

K12 ACTIVITY

PCE PILLAI COLLEGE OF ENGINEERING

ISHRAE PCE Organises

K12

at Dr. Pillai Global Academy, Panvel

Themes

- Experiments on Thermodynamics
- Sustainable development

Date - 5th February 2021

Time - 12:30 PM (Grade 1 and 2)

Zoom Link - <https://pillai-edu-in.zoom.us/j/82509731142?pwd=MHkyVWpRY2dlOVhIVkk2THVQdy9yZz09>

Zoom ID - 825 0973 1142

Zoom Password - 981961

Online K-12

ISHRAE PCE Chapter in collaboration with ISHRAE Thane Chapter organized a K12 activity for school (K-12) students in which a session on two STEM topics was delivered by the ISHRAE PCE committee members. The topics covered during the event were Basic electric circuit and its components and Concept of momentum. The session was followed by a doubt solving session and a short fact / information sharing session on 5G networks.

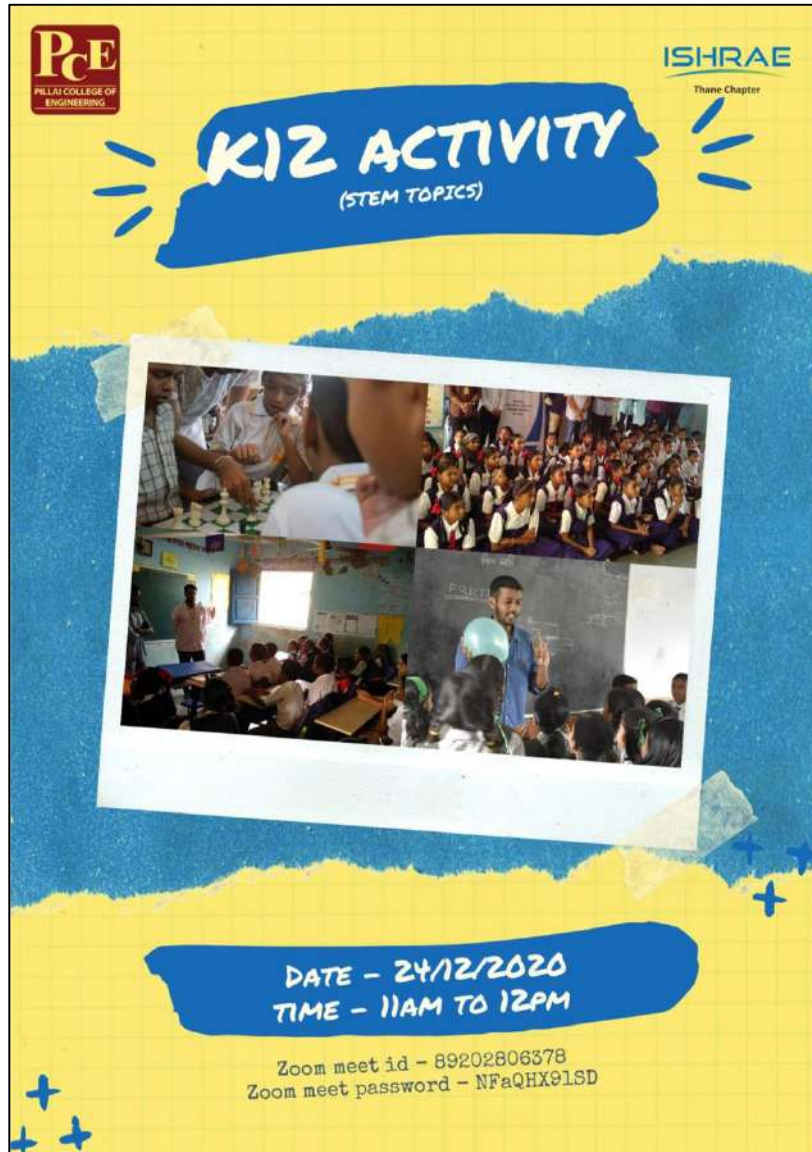

Squibble Solidworks

Mechanical Squibble Solidworks round was the second round of the Mechanical Squibble competition conducted by ISHRAE PCE. The competition was launched with the aim of helping mechanical students to learn and master Solidworks software in a competitive way. The competition was launched on 14th November 10:00 am and the deadline to submit solidworks files were till 15th November.



PCE **MECH SQUIBBLE: CAD ROUND** ISHRAE
PILLAI COLLEGE OF ENGINEERING PCE Chapter

After massively successful Mech Squibble: Quiz Round, ISHRAE PCE is back with
Mech Squibble: CAD Round

SW Winner will be awarded with
Amazon/ Flipcart Gift Card

Participation certificate will be provided to every participant

14 Nov 10:00 AM - 15 Nov 11:59 PM

Online K-12

ISHRAE PCE Chapter in collaboration with ISHRAE Thane Chapter organized a K12 activity for the students of Balagram Orphanage in which a session on “Academic and Career Guidance” was delivered by the event speaker Er. Rushikesh Dale. The online Zoom meet event was screened for orphanage students through a projector provided by Pillai College of Engineering. The event commenced at 11 am and was conducted for 1.5 hrs.



Online K-12
Initiative By
ISHRAE PCE

PCE
PILLAI COLLEGE OF
ENGINEERING

ISHRAE
Thane Chapter

Career Guidance

Er. Rushikesh Dale
Founder of PRAADNYA Academy
Motivational Speaker, Passionate Teacher

VENUE:
Balagram Orphanage, Panvel
7th November, Saturday
Time : 11am Onwards

IEEE



EVENT	DATE	SPEAKER
Demystifying IoT	July 25, 2020	Prof. Akhil Menon
Fundamentals of Python	August 1, 2020	Prof. Suchitra Patil
Fun with Bits	August 9, 2020	Dr. Rajendra H. Khade
Roots of AI and ML	September 12, 2020	Mr. Rahul Kharat

Demystifying IoT

The webinar on Demystifying IoT was initiated with a warm welcome and a brief introduction about IEEE and its membership benefits. Then a short video on the IEEE membership Drive was shown to get students well versed about the benefits. Prof. Akhil Menon enlightened us about the internet's status which covered topics like why it was invented, how we got involved in it, and why is it so important now in our everyday life. He gave an idea about Introduction to IoT as the Future of the internet and explained all the Current cases where it's used now. The basics of embedded systems such as how to turn on an LED, how MCU/MPU works, how communication between two devices can be established, etc. were precisely explained. He cleared most of our assumptions, myths, and doubts about IoT. IEEE PCE was thrilled to announce their new series called 'Bitfeed' which includes information about the latest technological advancements and a Quiz competition on various topics. In the end, the Staff Coordinator extended heartfelt gratitude on behalf of the whole IEEE PCE team and with a vote of thanks terminated the webinar.

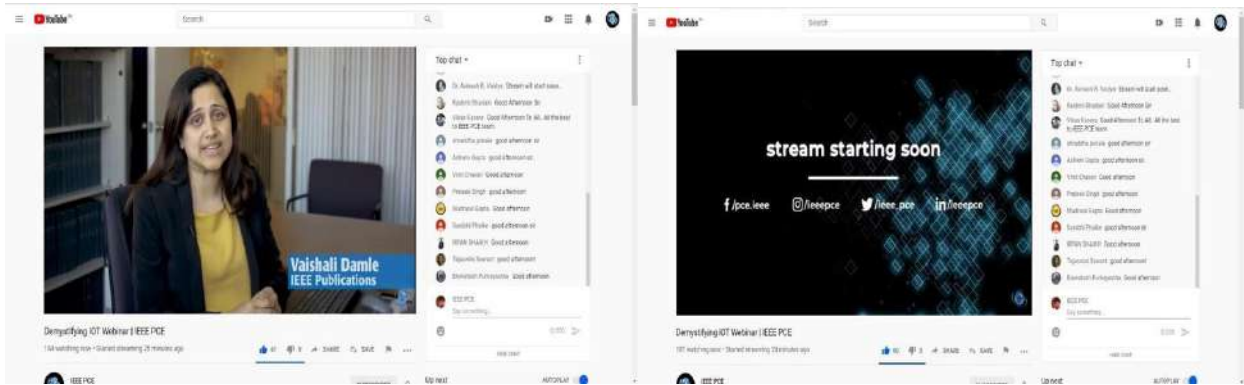

Fundamentals of Python

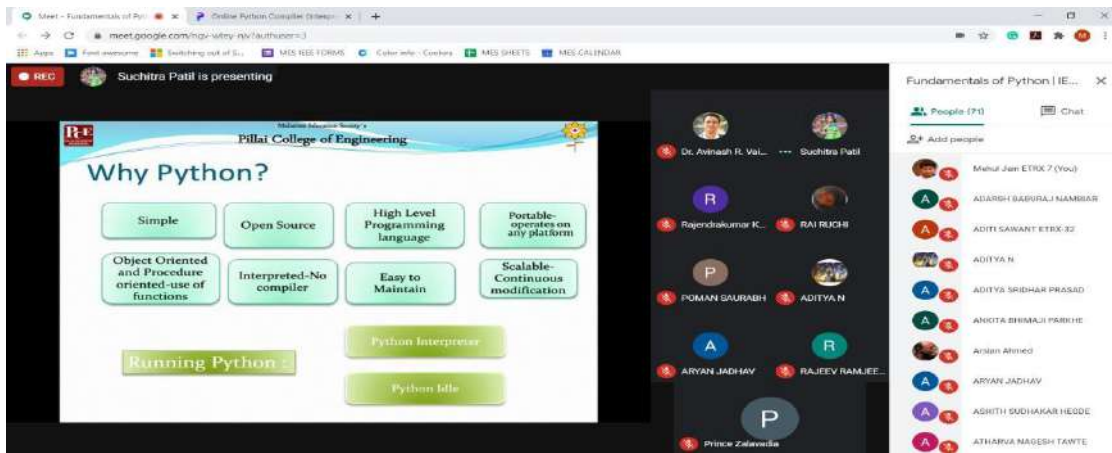

The workshop on Fundamentals of Python was conducted by Prof. Suchitra Patil, a professor at Pillai College of Engineering from the Electronics and Telecommunication Engineering department through Google Meet. It began with a warm welcome and a small introduction about IEEE PCE. She commenced the workshop by giving all the basic knowledge regarding python including small terms and concepts of python such as data types, variables, input-output operations, and basic operations. She explained each concept followed by hands-on training and coding. The main aim of this workshop was to give a better understanding of python so that the participants can use it shortly. The workshop concluded with a vote of thanks and our Staff Coordinator expressed her gratitude towards everyone on behalf of the IEEE PCE Council. E-certificates were provided to all by filling the feedback form and the workshop turned out to be very fruitful and informative for everyone.

Fun with Bits

The workshop on Fun with Bits was conducted by Dr. Rajendra H. Khade, HoD of Electronics and Computer Science, and Student Branch Counselor of IEEE PCE. The name Fun with Bits suggests an idea related to bits. It was based on Digital Circuit Designing and K- maps as the main base of circuit design. The topics covered were K-maps up to 4 variables, various combinational circuits such as half adder, full adder, full subtractor, and many more. He explained every topic theoretically as well as practically through implementing three different virtual labs on various circuits. He made sure that everyone was getting the desired output by asking them to present their screen through Google Meet and cleared all their doubts simultaneously. The workshop proved to be helpful, illuminating, and ended with a vote of thanks wherein our Staff Coordinator expressed her heartfelt gratitude towards everyone and E-certificates were provided to all through the feedback form.

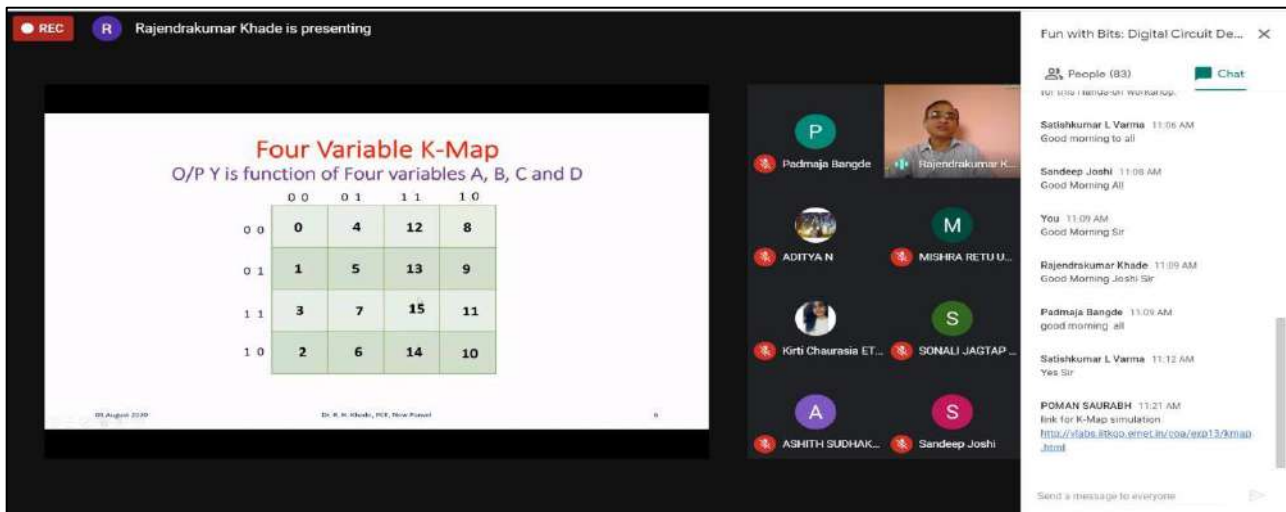

Explaining the concept of the topic fundamentals of Python

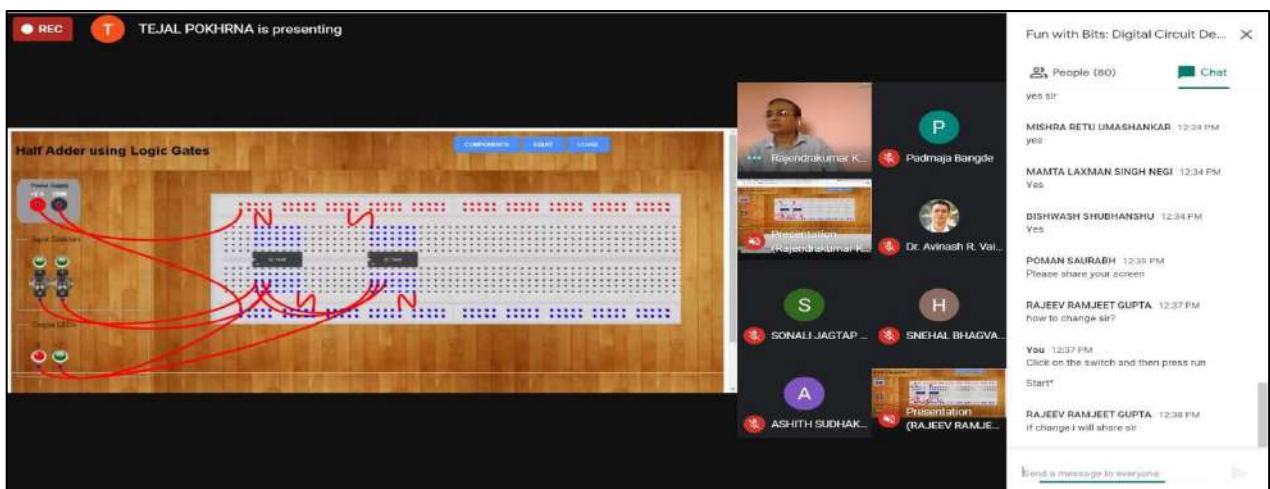

Roots of AI and ML

The Webinar on Roots of AI and ML was conducted by Mr. Rahul Kharat, Ex- Director of the Head of Artificial Intelligence, Eton solutions, and Senior Managing Consultant of AI and Analytics at IBM having 15 patents. The webinar commenced with a brief introduction about the IEEE PCE membership benefits. The main aim of this webinar was to make students familiar with the concepts of ‘Artificial Intelligence’ and the basics of "Machine Learning". He began by giving students proper basic knowledge about the topic as it was slightly different for everyone. All the fundamental contents related to AI and ML such as introduction to AI, AI drill- down, Introduction to Machine Learning, ML types, Sample used cases, and Methodology. Presentation with sufficient information and knowledge was provided followed by a Question and Answer session in the end to clear all the doubts. The workshop concluded with a little information on Bitfeed series, a vote of thanks, and e-certificates were provided to all by filling the feedback form.

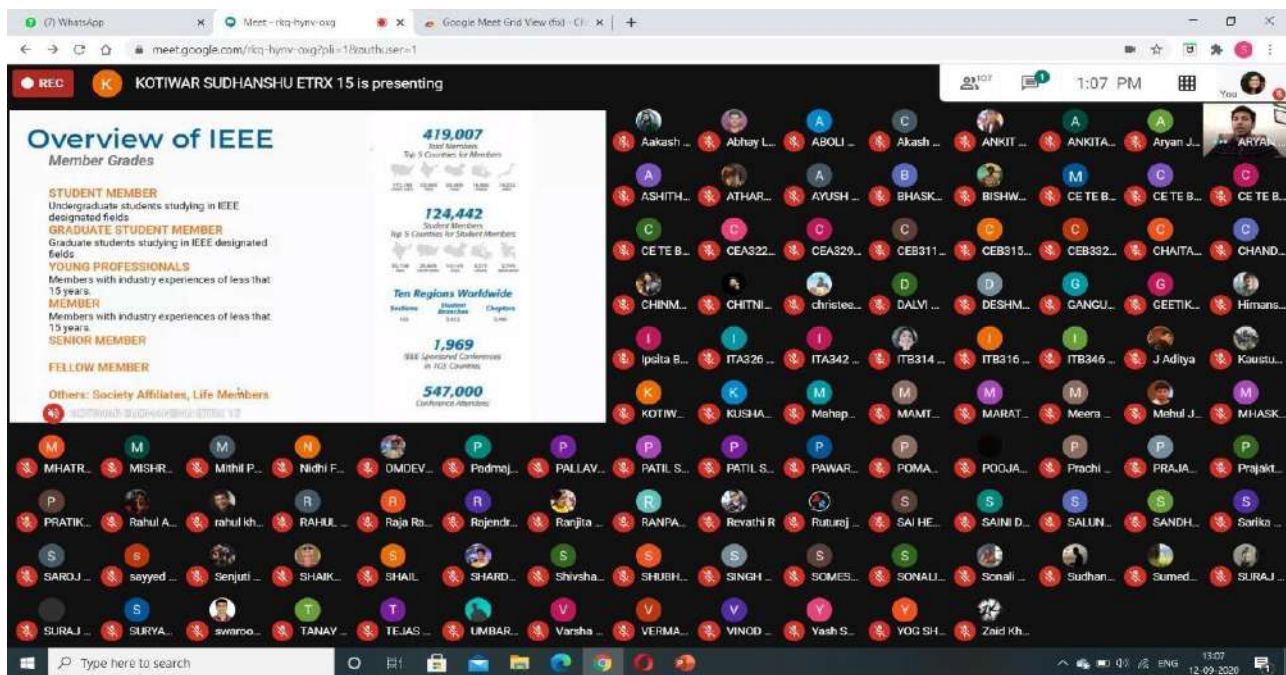



ETSA



Sr. No	Event	Date	Speaker
1.	Cyber Security	8 th August, 2021	Mr.Devang Karelia
2.	LaTex Workshop	6 th September, 2020	Prof. Ruchira Patole
3.	Blockchain	12 th September, 2020	Mr.Arjun Sasikumar
4.	Startup Talk Series 1	19 th September, 2020	Mr. Priam Pillai Prof. Arun Pillai Prathamesh Damle Ketan Jain
5.	Creative Carnival	29 th September, 2020	
6.	Startup Talk Series 2	12 th December, 2020	Mr.Swapnil Gaul
7.	Python Workshop	6 th February, 2021	Mr. Vivek Vaishya
8.	Women's Day	7 th March, 2021	-
9.	Startup Talk Series 3	27 th March, 2021	Prof. Munawira Pillai Prof. Salim Jafri
10.	Proteus Workshop	17 th April, 2021	Prof. Aboli Khedkar
11.	Etsa Talks	24 th April, 2021	Mr. Maruti Pawar



Cyber Security

ETSA PCE organized a webinar on “Cyber Security & Ethical Hacking” on 8th August 2020, 12:30 PM to 2 PM on the online platform Google Meet. The speaker for the event was Mr. Devang Karelia. He is an ethical hacker and a cyber security researcher. He is also the founder of proton security. During the workshop, students were informed about the different types of hackers like black hat, white hat, grey hat, red hat, etc. After this, they were informed about what are the different ways and various processes of hacking were explained in detail. Live demonstration of ethical hacking was shown followed by a doubt solving session.

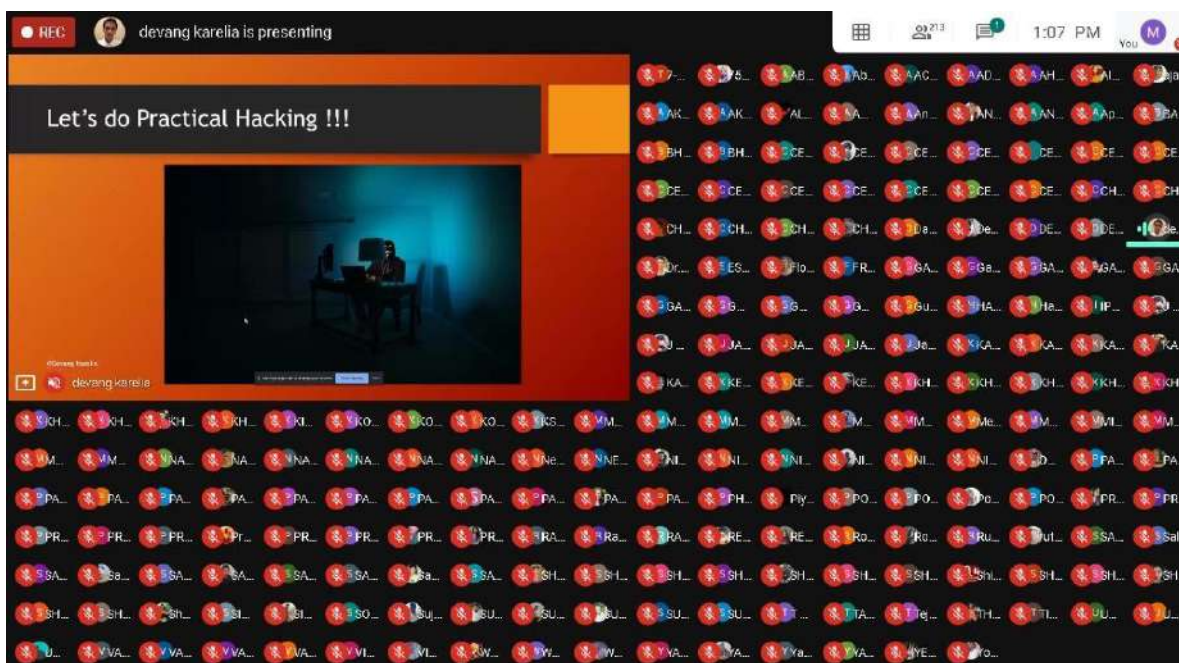

A grid view of the event showcasing a majority of the participants and the workshop presentation

LaTeX Workshop

LaTeX workshop was conducted on 6th September 2021 from 4:00 PM to 6:00 PM on the online platform Google meet. The speaker of the workshop was Ms. Ruchira Patole. During the workshop, students were trained to prepare their own black book with the help of LaTeX which will help them to prepare their own reports and black book for their final year projects. The speaker showed how to make a document using LaTeX, how to add contents, tables and graphical image in the documents. Students were acquainted with the methods to insert any text or images according to them.

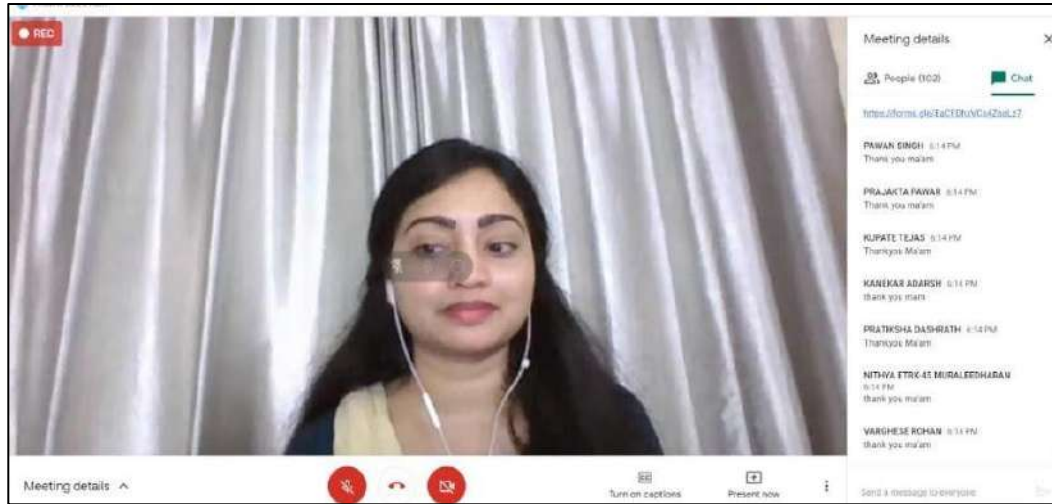

Prof. Ruchira Patole, the speaker for our event giving out instructions to students

Blockchain

The Blockchain webinar was conducted on 12th September, 2020 from 3:30 PM to 5:00 PM on the online platform Google meet. The speaker of the event was Mr. Arjun Sasikumar. The webinar made the attendees aware of blockchain and its applications in cryptocurrency. A PowerPoint presentation was used by our speaker to explain the topic. He started with the history of money, which defines the changes in the field of currency i.e from barter system to cryptocurrency. He explained about bitcoin and what are the different types of cryptocurrencies. The event conducted with a doubt solving session.



The speaker solving the doubts of students



Startup Talk Series 1 in association with IIC

PCE
PILLAI COLLEGE OF
ENGINEERING

Mahatma Education Society's
PILLAI COLLEGE OF ENGINEERING

ETSA

Startup Talk Series

Experience Sharing by
Campus Entrepreneurs

**19 Sept | From
2020 | 3pm**

SPEAKERS

Dr.Priam Pillai
Valectus Pvt.Ltd

Dr.Arun Pillai
Trendset Power & Technology
Consultants Pvt.Ltd.

Prathamesh Damle
VLiNK

Ketan Jain
Indian Hybrid

**INSTITUTION'S
INNOVATION
COUNCIL**
(Ministry of HRD Initiative)

CONTACT
VISHNU- 81082 21107
ALVIN- 80979 75214

/etsa.pce /ETSA PCE /EtsaPce

ETSA-PCE organized a webinar called the “Startup Talk Series” on 19th September, 2020 from 3:00 PM to 5:30 PM. The event was conducted on online platform Google meet. The event consisted of a total of 4 speakers who gave the attendees of the event insights into their start-ups. The first speaker was Mr. Priam Pillai. He talked about his startup Valectus Pvt. Ltd and about how the idea for the company was developed. The second speaker for the day was Prof. Arun Pillai. He talked about his Trend set Power and Technology Consultants Pvt. Ltd and how the



idea of the company struck him when he saw a transformer bursting into flames. The third speaker for the event was Prathamesh Damle who is a student of PCE. He talked about his startup Vlink which he has co-founded with a few of his friends. He shared about his whole journey which involves a lot of failures and setbacks. The last speaker for the event was Ketan Jain who founded a startup called Indian Hybrid. He is also a student of PCE and has been working on this idea for the last 6 years.



The first speaker for the event, Mr. Priam Pillai

Creative Carnival

ETSA organised an event called “CREATIVE CARNIVAL”. It was conducted from 5th October to 20th October, 2020. The event was conducted for a period of three weeks with each week consisting of two competitions each. Entry fee for every competition was 30 rupees only. The first week of Creative Carnival consisted of competitions named ‘Life sketchy’ and ‘Insider’. Life sketchy was for sketching and paintings. The second week of Creative Carnival consisted of competitions named ‘Meme Master’ and ‘Poster Design’. The topics for meme master were college life, reality show and lockdown memes. And on other hand the topics for poster design were Covid-19 awareness and environment awareness. Each participant was allowed to give only one content for each entry. The third week of Creative Carnival consisted of competition named ‘Entertainment’ and ‘Poetry Sangraam’. Entertainment included dance competition in which the participants were allowed to take part in solo, duo and group dance. The winners of each competitions were decided by considering the votes of jury members and the votes from social media. The event was successful with an overwhelming response.



Startup Talk Series 2 in association with IIC

ETSA PCE organized a webinar “Startup Talk Series” on 12th December, 2020. The speaker for the event was Mr.Swapnil Gaul, Founder of Numeregion PVT LTD. The session started at 6pm on the online platform Zoom. This webinar was free for all the participants making the attendees aware of startups and the initial hurdles that most people face while trying to make it big. A PPT presentation was used by our speaker to explain various concepts. Swapnil Gaul started with his journey from a Techie to Entrepreneur, which shows how much dedication and time should be given in this field. He explained the basic difference between business and entrepreneur which one should know. The doubts of the students were solved during a Q&A session.

PCE
PILLAI COLLEGE OF
ENGINEERING

Mahatma Education Society's
PILLAI COLLEGE OF ENGINEERING

ETSA

Startup Talk Series

Product Pivoting for MVP stage

**12 Dec | From
2020 | 6 pm**

SPEAKER

Mr. Swapnil Gaul
Founder Numeregion PVT LTD

**INSTITUTION'S
INNOVATION
COUNCIL**
(Ministry of HRD Initiative)

CONTACT
VISHNU- 81082 21107
ALVIN- 80979 75214

/etsa.pce

/ETSA PCE

/EtsaPce



The speaker motivating the students

Python Workshop

ETSA PCE organized a webinar “Python” on 6th February, 2021. The speaker for the event was Mr. Vivek Vaishya. He is a fourth year Engineering student of Computer Engineering department. The session was conducted in the light of the pandemic, from 12:00 pm to 3:30 pm on the online platform Google Meet. Our speaker, Mr. Vivek Vaishya started by explaining the basics of Python. He then interacted with the attendees and made sure that everyone was equipped with the required software for the workshop. The first topic explained at length was Object Oriented Programming and how Python itself is an object-oriented program. He also touched upon topics like Advanced Python and GUI development Pyside 2(Qt). Finally, the whole workshop culminated with the attendees being coached into developing a code for a two player Tic Tac Toe game.

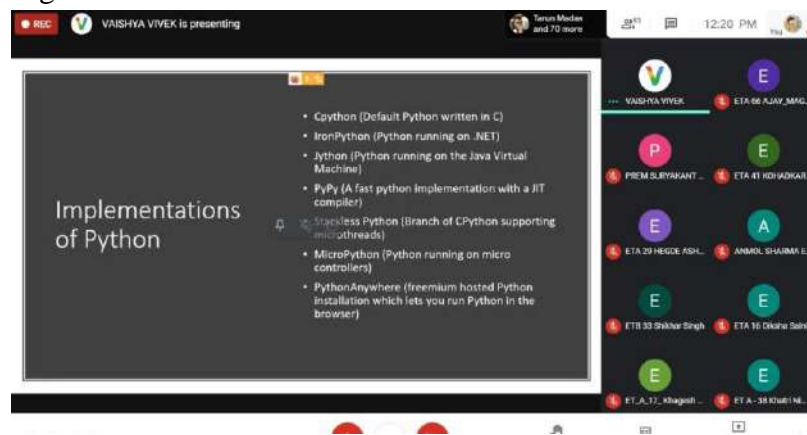

A grid view of the event showcasing a few participants and the workshop presentation.



Startup Talk Series 3 in association with IIC

ETSA PCE organized a webinar “Startups Talk Series” on 27th March, 2021 from 12:00 PM to 1:20 PM. This was the third time an event on the same topic was conducted by ETSA with two new speakers. The session started at 12pm on the online platform Zoom. Our first speaker for the day was, Prof. Munawira Pillai. She started the actual session after a brief introduction about Startups. She prepared simple slides to explain every topic precisely. She also shared her journey which led her to a successful business venture. Our second speaker was Prof. Salim Jafri. He provided some insights on the differences between startups and business. He explained about his startup and advised that proper collaboration with people is very important. The doubts of the students were solved in a Q&A session later on. Both our speakers’ journeys about starting from scratch to successful startup was really inspirational.

PCE Mahatma Education Society's
PILLAI COLLEGE OF ENGINEERING **ETSA**

Startup Talk Series INSTITUTION'S INNOVATION COUNCIL
(Ministry of HRD, Government of India)

Interactive Session with Successful Start-up founders

27 MAR | 12 pm
2021 onwards

SPEAKERS

 Mrs. Munawira Pillai
Founder-Partner at Wonderwheel Enterprise

 Prof. Salim Jafri:
Proprietor at bombaybots.com

CONTACT
Preeti - 9867497059
Harsh - 9422875772



 /etsa.pce  /ETSA PCE  /EtsaPce

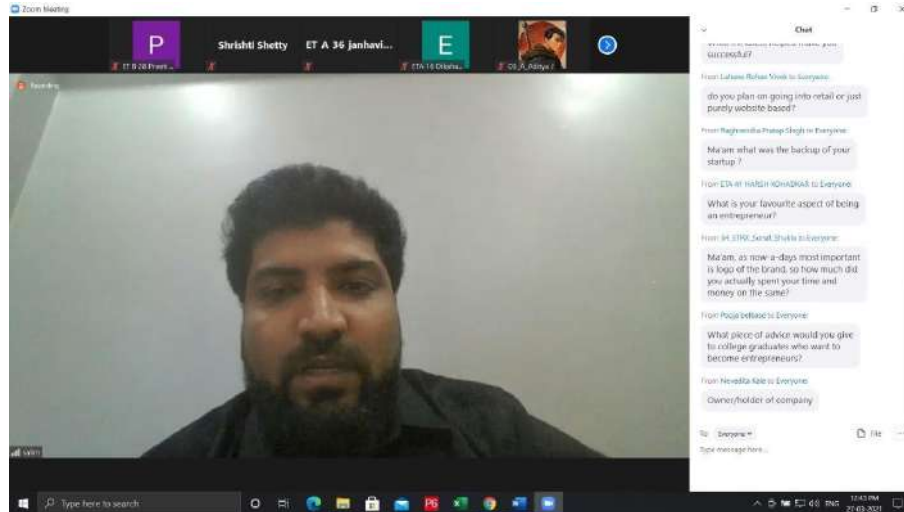

The second speaker for our event, Prof. Salim Jafri

Proteus Workshop

ETSA PCE organized a workshop “PROTEUS” on 17th April, 2021 from 4:00 PM to 6:30 PM. The speaker for the event was Prof. Aboli Khedkar. She is proficient in this domain. The session was conducted on the online platform zoom. The Proteus is a proprietary software tool suite used primarily for electronic design automation. The software is used mainly by electronic design engineers and technicians to create schematics and electronic prints for manufacturing printed circuit boards. Our speaker started with the demonstration of building a circuit for Non inverting amplifier circuit and told the attendees of the event to follow along. The session was quite interactive as the participants shared the various problems they encountered and our speaker was kind enough to give a brief explanation on how to solve the problems. Lastly our speaker moved on to PCB designing and demonstrated the steps to follow for designing a PCB on the Proteus software. It was a really interactive session and the participants were able to clear all the doubts and properly learn how to use the Proteus software.

ETSA TALKS

ETSA PCE organized a webinar for their annual “ETSA TALKS” on 24th April, 2021 from 11:00 AM to 12:30 PM. The speaker for the event was Mr. Maruti Pawar. The event also consisted of the CIRKYE magazine launch. The event began with President of ETSA, Nivedita Kale giving a brief introduction about the committee and talked about how even though the pandemic ETSA conducted and hosted various workshops and webinars for the benefit of the students. After the president, the speaker for the event Mr, Maruti Pawar Sir took over the event. He started the session by talking about his inspiring story of how he wasn’t able to pursue an undergraduate degree due to his unstable financial condition but he still persevered through the years. He talked about his journey from there to becoming a Managing Director of Amptronics.



After an inspiring session , Divya Wairkar, ETSA's Magazine Head spoke a few words about ETSA annual magazine CIRKYTE.

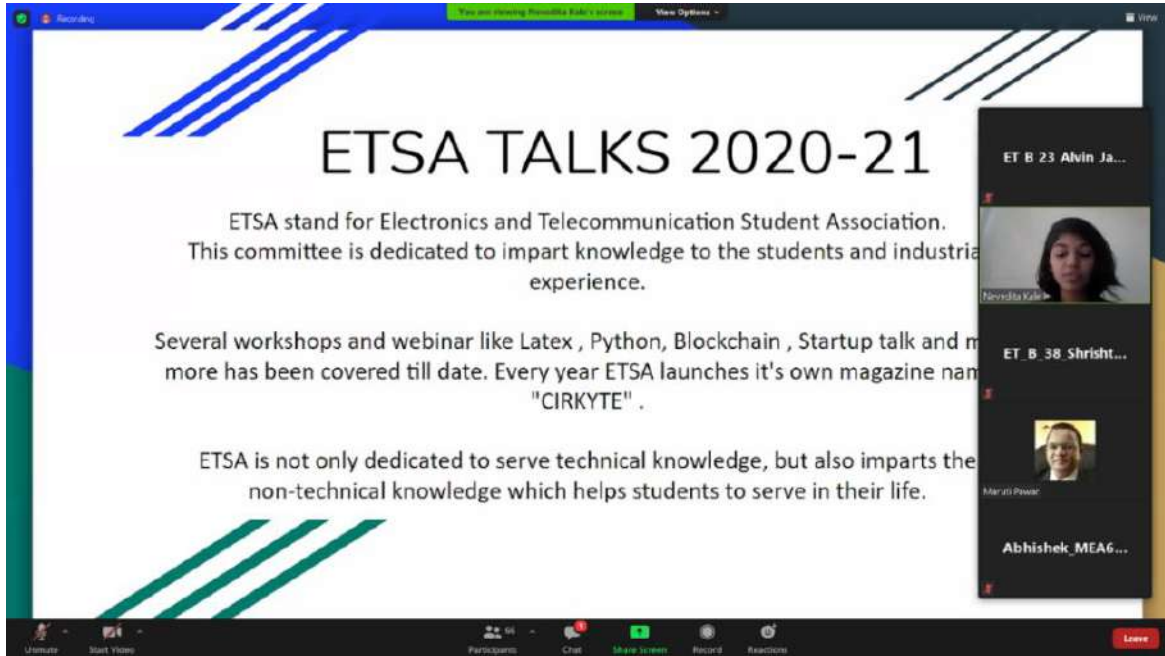

ETSA President Nivedita Kale talking about ETSA



SAE

SAE-PCE

SAEINDIA Collegiate Club of PCE

Sr No	Event Name	Date
1	Webinar on BS-VI Technology in Commercial Vehicles	26 th September, 2020
2	Essay Writing Competition	23 rd January, 2021
3	Webinar on Engine Design	20 th March, 2021
4	Webinar on All About Studying Abroad	17 th April, 2021

Webinar on BS-VI Technology in Commercial Vehicles



Online Webinar on BS-VI Technology in Commercial Vehicles

In Association with Nichat Human Resource Solutions





Mr. Pramod Nichat
MD, Nichat HR Solutions
Ex. Asst General Manager,
Ashok Leyland Ltd.
Mobile: 95525 45723
Web: www.nhrs.in



Mr. Anurag Saxena
Divisional Manager
Service Training Center,
Ashok Leyland Ltd, Chennai



September 26, 2020
11:00AM - 1:00PM

<https://tinyurl.com/saepecbs6> Contact: 9930594695 (Shridhar) / 7021543302 (Deepali)



Due to the increased air pollution in major cities, the government of India has regularized the BS-VI emission norm. To know about what this technology is, SAE-PCE chapter successfully conducted a webinar on “BS-VI Technology In Commercial Vehicles” on Microsoft Teams. It included vehicle emission and its hazardous effects on environment, how government is trying to control these emissions by BS VI etc.

Essay Writing Competition

PCE
PILLAI COLLEGE OF
ENGINEERING

Pillai

As a tribute to the great
**NETAJI SUBHASH CHANDRA
BOSE**

All Student Bodies of PCE have joined
forces to organise following events

- **Poster Competition**
- **Sketching Competition**
- **Patriotic Singing
Competition**
- **Debate Competition**
- **Poetry Competition**
- **GK Quiz**
- **Essay Writing**
- **1 Min Video Competition**

Scan the QR code
for the form link



The Essay writing competition was held on 23rd of January on the occasion of Netaji Subhash Chandra Bose birth anniversary. Participants were instructed to submit their responses through google form. PCE Student Council was responsible for collecting all the responses of the participants. The competition was judged by Prof. Rakhee Nair, Dept. of Humanities.

Webinar on All about Studying Abroad

**All about
studying abroad**

Free Webinar

*Limited seats

Learn about: Scholarships, top countries to study in, building a profile, studying overseas amidst COVID-19 and more!

Saturday April 17, 2021 2:00PM - 3:00PM IST

REGISTER AT [BIT.LY/PCESTUDYABROAD](https://bit.ly/pcestudyabroad)

iSchoolConnect

PCE
PILLAI COLLEGE OF
ENGINEERING

SAE-PCE successfully conducted a webinar on “All About Studying Abroad” on Zoom Meet. Speaker for the webinar was Ms. Malavika Issar, a very proactive and knowledgeable coach at i-school connect to train students who wish to pursue their career abroad. Topics covered in webinar were: Study Abroad Road map, University Research, SOP Writing, Profile Building and Admissions Interviews. Total 63 students registered for the webinar and 30 students attended the webinar. It was an interactive session between students and Ms Akanksha Vora and Mr Aditya Mirani.



VANGUARD Racing Team



The Vanguard Racing Team is a group of undergraduate students committed to engineering excellence and achieving groundbreaking success. It's a diverse group of students all working towards a successful season made up of designing, building, racing and presenting an off-road vehicle as a true engineering company. In the first project 17 students were part of the team which develop an IC engine based race car and successfully participated at international level in competition BAJA 2K17 which is held at South Africa.

The vehicle implements conventional powertrain which involves a sophisticated arrangement of Engine, Transmission, CVT, half shafts, to give required performance. Two stage Gearbox, made up of aluminum alloy with gear ratio 11:1 has been used for the car. Due to the pandemic situation the manufacturing process of the chassis couldn't be performed. So, in the mean time improvements were made in the current design and analysis for each and every component was performed.

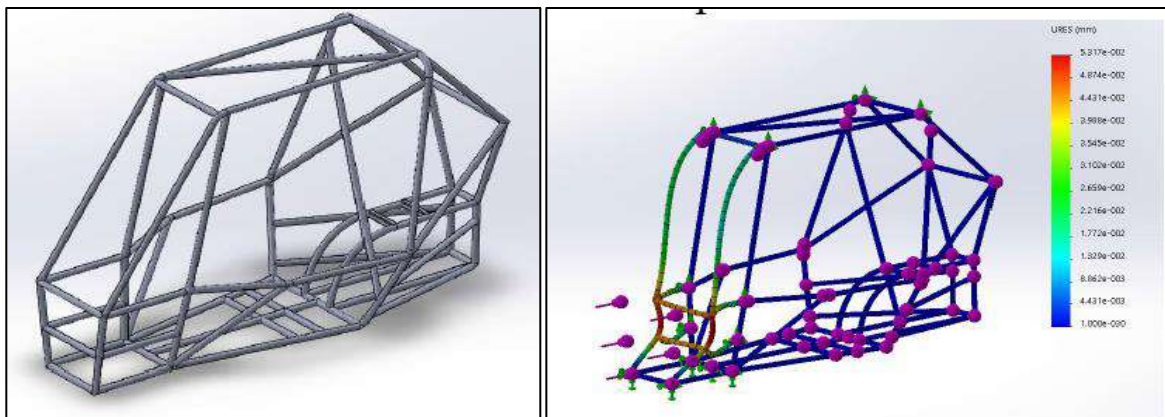

Design of chassis and analysis

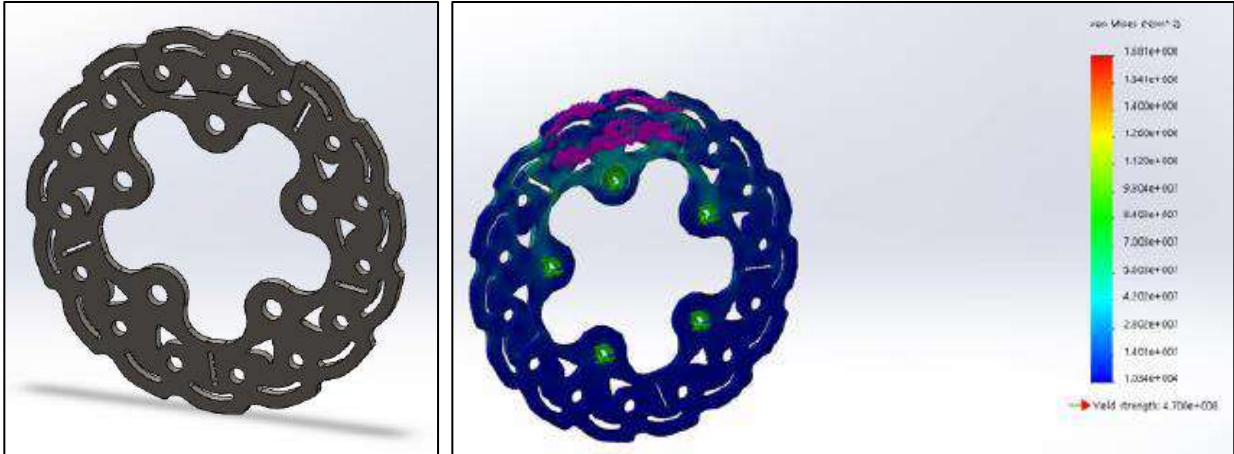

Design of Brake Disc and Analysis

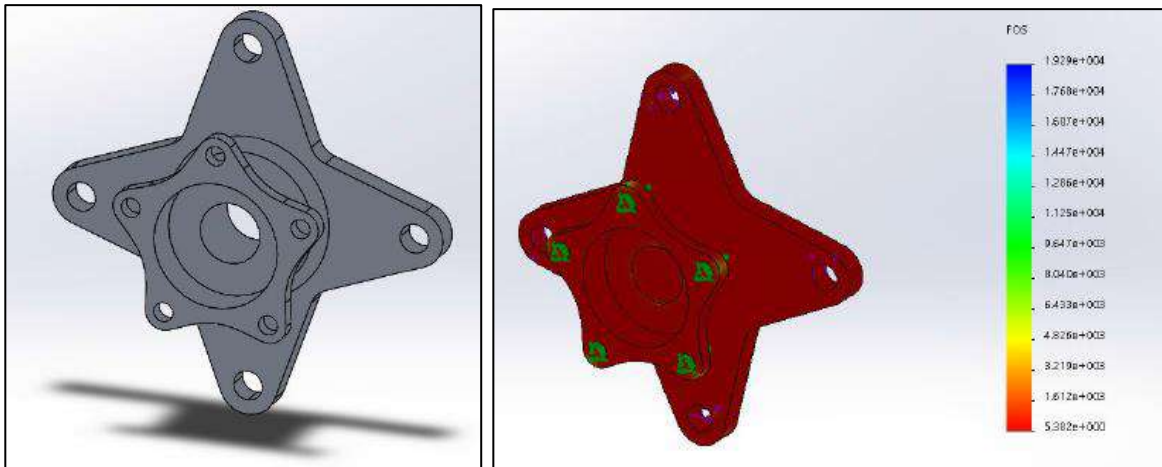

Design of Front Hub and Analysis

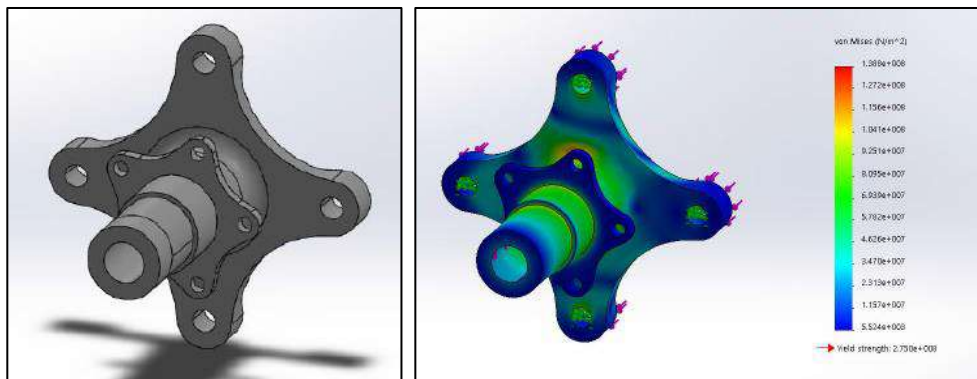

Design of Rear Hub and Analysis



Fabrication Done in the year 2020-21

Work left to be done

1. Removing rust from chassis using sand paper
2. Arc welding of chassis
3. Manufacturing of body panel
4. Complete mounting of H-arms. A-arms and Hubs.
5. Complete mounting of powertrain on roll cage
6. Brake system mounting
7. Mounting other accessories
8. Final testing and debugging



Spark Racing Team



Spark racing team is one of the student racing teams of Pillai College of Engineering who focuses on Electric Vehicles. The motto of the team was to go green so it started off with a Solar Vehicle and then moved ahead with an Electric Vehicle. Spark Racing Team was the first EV team in Navi Mumbai.

FSEV PREPARATION - February- June:

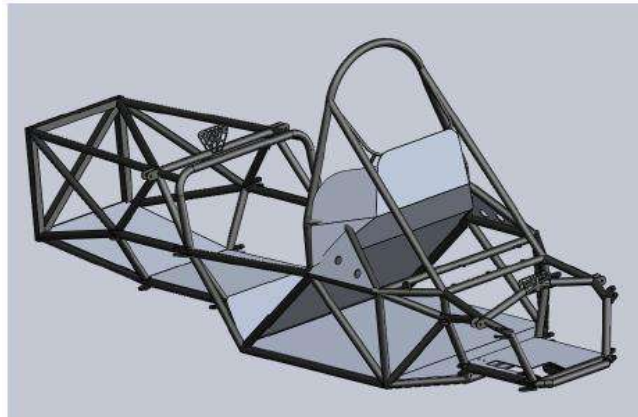

The team missed out on the chance to participate in the Formula Bharat 2020 because of some issues so they participated in the FSEV competition with a motive to validate the design for the upcoming Formula Bharat. They developed a new chassis as a fresh start to the competition. They added two more fans to the existing two fans in the battery cooling system. Each team member worked on the documentations to meet the deadlines. Every department started working in their respective fields to prepare for the questionnaire round.

FSEV COMPETITION - July, 2020:

Now it was time for all the preparation to finally work. The team gave their best but did not get the results as expected. The overall rank of our team was 33 out of 37. They learnt a lot from the competition and started working even harder for the next one.



Recruitment - August, 2020:

Team started recruiting new members from 2nd, 3rd & 4th year from Mechanical and Automobile Engineering. They also widened the search by opening up to the Electronics and Telecommunication Engineering and Electronics and Computer Science branch as people with an electronic background was needed. The recruitment drive was divided into 3 parts. First, there was a quiz about the basics of cars and physics related to it. The second round consisted of a pre-interview test based on the rulebook of Formula Bharat. And finally, if they cleared both these rounds, a face to face interview was held. At the end of the recruitment process, 8 new members were recruited and assigned their specific departments.

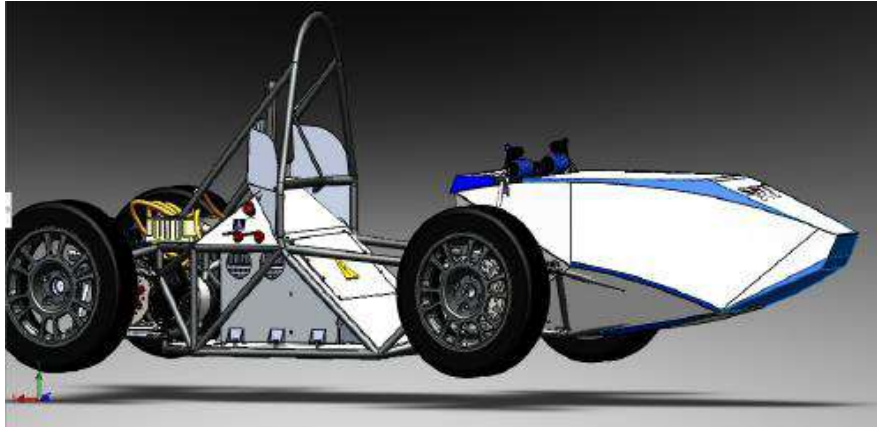

Guiding the Second Year Members - September, 2020:

The new members were told to be thorough with the rulebook at first. Once they were done with that, they were given some reference books related to their departments to get deeper knowledge about the same. Frequent meetings were held by the seniors in the team to clear all the doubts the new members had. The freshers were given some tasks for which they had to put their gained knowledge to work.

Planning of A New Car - October, 2020:

In spite of the pandemic, the team started thinking of designing a new car from scratch for the upcoming competitions. Due to lockdown, each and every task was done online which made it tougher than normal to execute. Video meets were arranged regularly, discussing the new ideas and design for the car. The new members were playing an important role as the seniors guided them through the path.

Design and Study Phase of the New Car - November, 2020- January, 2021:

Every department started doing their study and calculations all through the online medium. Team started looking for all the sources that they had and thought of using the parts from the previous car which were in a good condition, for example dampers and differentials.

Pune Visit - March, 2021:

The powertrain department was having some issues with the car's powertrain. Team found out that an industrial expert and a dealer of powertrain in Pune. Some of the members went there to know the cause of the problem. The visit made the team realized that the issue could not be solved and they have to get a new powertrain.



Hyperion Racing Team



The Team of Hyperion Racing for the year 2020-2021 consisted of students from a varying level of academia i.e from Second Year to Final year engineering students thus, providing an equal opportunity for all levels of education and experience to comprise in the efficient designing and manufacturing of the car. The Team was led by Aditya Vipin along with Vice-Captains Siddharth Nair and Akshat Pandey. The Team was efficiently handled by the respective Sub-System leads that were assigned accordingly to their academic and experience level. The team was proficiently guided by Our Technical Advisor - Anil Unnikrishnan Pillai and our Faculty Advisor - Prof. Amey Marathe. Due to the pandemic situation that arise during March 2020 Formula Student event went online for the 2021 season wherein the team performed exceptionally well securing a overall national rank of 25th and also excelled the business plan event with the rank of 22nd and 28th in the design event.

About HRT 04



HRT 04, the Upgraded fourth generation car of the team is designed as a lap time car. Optimization of performance at cornering was taken into consideration while designing the car. HRT 04 is so far the most compact design that Hyperion racing team has ever come up with. The



car houses various special design cues like the compact chassis, clean and efficient electronics harness housing, custom electronic harness, a highly efficient intake manifold, custom free flowing exhaust and much more. The car itself is a pioneer among all the vehicles manufactured by Hyperion Racing team. HRT04 stands at a peak of excellence pointing towards designing fields. The car includes many modifications and upgrades made after the vehicle returned from Formula Bharat 2020, all put together in order to attack Formula Bharat 2021. Simple, noteworthy designs is what sets the HRT 04 apart from most Formula Student vehicles.

Department-wise Report Points

A. Vehicle Dynamics

The weight distribution value for HRT 04 was taken as 45:55. This value was assumed by the seniors. Therefore, judges suggested not assume any value out of thin air. It should have any base of justification to it. Also, all the calculations were done with reference from RCVD. Judges asked not to follow any methodology blindly and should be done with proper understanding on an individual level.

B. Braking System

Issues that were found in technical scrutineering of FSB 2020 were fixed by making minor changes in design of brake assembly. The whole brake system was perfectly working and functioning at any given point, all 4 wheels were locking as expected and the required pressure for BSPD and the Brake Light Circuit was also achieved in FSB 2020 and the same design was used in Virtual Event 2021.

C. Chassis

There was a major change in the structure of Chassis. The main aim was to increase the torsional stiffness of the car, to lower the center of gravity and to increase the visibility of the driver. So, the front bulkhead was lowered. The main hoop and the front hoop which lowered the center of gravity by 21mm. Body panels material were switched from FRP to carbon fiber as the team was planning to build an aero kit in the future.

D. PowerTrain System

Mistakes made in last year's scrutineering was rectified by minor changes in design. All issues related to safety that can be fixed by changing design was done and no major changes were involved. Simulations related to engine, exhaust and radiator were inadequate and was pointed out by the judges which the team is going to work out for the upcoming designs. New developments related to DAQ system, Gear shifting, exhaust and radiator were being made considering all feedback received from judges.

E. Electronics System

New systems are being developed with improved custom PCB that will suite needs. DAQ, Dashboard Driver information system and gear shifting are being developed with first priority



being given to DAQ as this was never made in the team before and no testing results are available. Things pointed out by judges were being taken into consideration while making steady progress in development of electrical systems.

Future Scope

The future of Hyperion racing stands strong as getting back on track quite literally has set a margin of achievements in terms of both experience and knowledge. With the help of different academic level student members, Partners, Sponsors, support of Pillai College of Engineering and its inhouse facilities, Hyperion Racing now has stood up as a name of recognition for the institute. Team plan for the future include efficient manufacturing of bespoke Race-Ready Formula Student Vehicles and participating in maximum events that come through academic year. They plan to conquer Formula Bharat Virtual 2021, Formula Supra 2022, FSS 2022 in the next upcoming season. After the experience in the Formula Student Season national event held in India, the team will work towards a greater goal with adequate testing data and event experience towards international events. Hyperion Racing will set a reputable mark and ranking at Formula Student Germany, Formula UK, and Formula Student Austria in the year 2024. They believe the team itself has the commitment and the passion to drive the upcoming team to success and prosperity, teaching the students of Pillai College of Engineering, shaping them into extraordinary engineers and promising them a greater life in the pre-established industry of Motorsports.



TAPAS

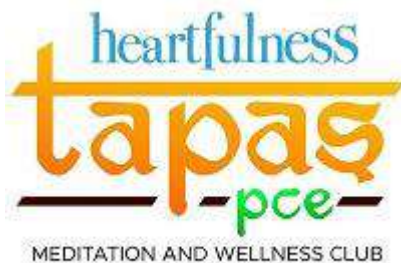

Sr. No.	Event	Duration / Date	Participants Count
1	Remote meditation sessions	23 rd March 2020 till date	143
2	Yoga for compassion	21 st , 22 nd and 23 rd June, 2020	225
3	Dhyantsav 2020	19 th , 20 th and 21 st October, 2020	240
4	21 Days Meditation Challenge	1 st to 21 st March, 2021	93

Remote meditation sessions

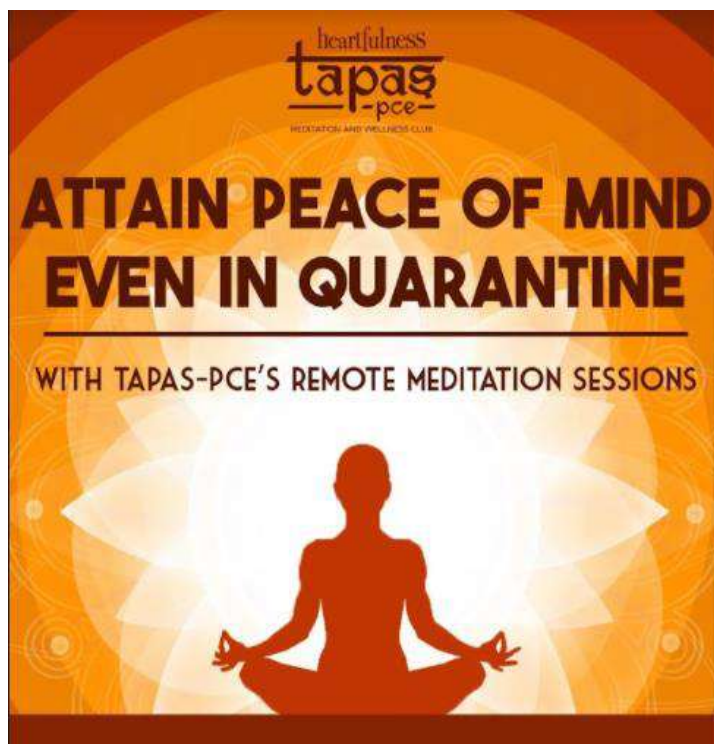



Due to the sudden lockdown the usual practice of meditation couldn't be continued. Students of TAPAS came up with an idea of conducting online remote meditation sessions for all students of PCE. A Whatsapp group was created for all the members willing to attend remote transmission based meditation. Everyday 4.00pm to 4.30pm the meditation session is being conducted. With the popularity many members outside PCE also joined the group. Many students and faculty members also included their family members as a part of the group and got benefited. To train every newly joined member initially voice based commands were shared with all through the group. The practice of daily meditation has benefited all in the group. A very positive feedback is received from all. Sessions are conducted by faculty of pillai college group who are also certified meditation trainers of heartfulness institute: Dr. Nivedita Shreyans, Prof. Madhura Vyawahare, Prof. Shilpa Mondkar and Prof. G.V. Patil.

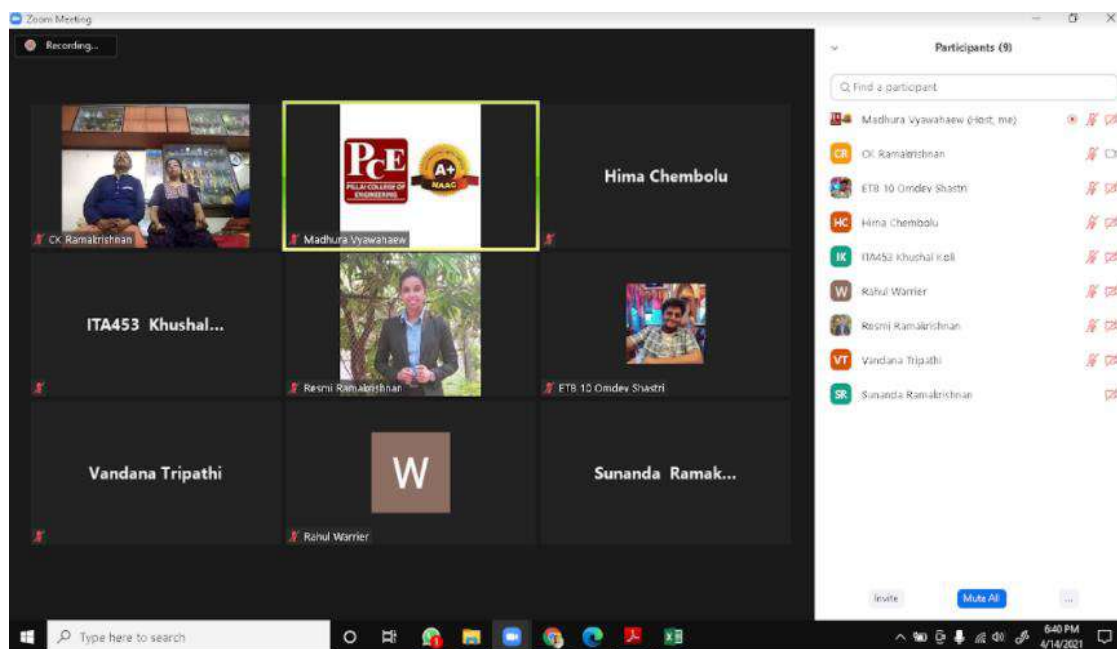

Yoga for Compassion

“Yoga for Compassion” was a Meditation event which was organized by Pillai Group of Institutions with the help of Heartfulness institute and TAPAS-PCE for relaxation, meditation and rejuvenation/cleaning practices. More than 250 members including faculty and students participated in the event. This event was divided into a three days session program. Volunteers from TAPAS-PCE helped to organise and ensure the smooth flow of the program.

Youtube Link : <https://youtu.be/Ndpa2sUWoSM>

Sessions on first day were conducted by Yoga instructors *Ms. Sukhdeep Dhillon Sahijwani*, Corporate lawyer, Yogatrainer, tness Corporate Coach & *Mr. Tushar Pradhan*, Chief Investment Officer, HSBC Asset Management Company, Heartfulness Meditation Trainer and Zonal Coordinator, Mumbai Metro Zone. The 2nd day session was conducted by *Ms. Saloni Godbole*,

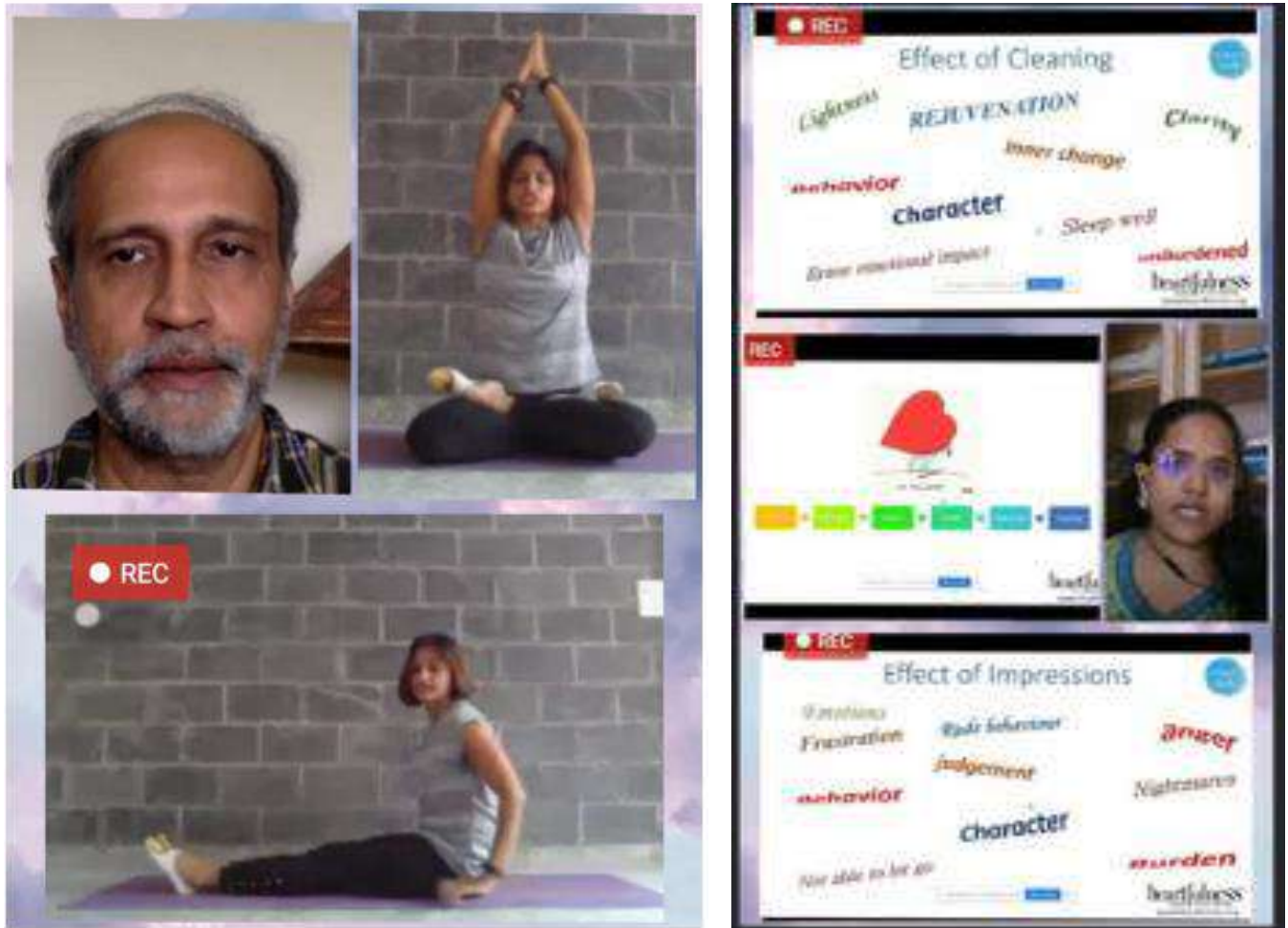

Co Founder and Director Occamy BioScience Pvt. Ltd. 3rd day session was conducted by Mr. Shridhar Thoda, Certified Adizes Associate Heartfulness Meditation Trainer.

Glimpse of the Event

Dhyanotsav 2020

Dhyanotsav was a Meditation event organized by TAPAS-PCE for SE students of Pillai College of Engineering with the help of Heartfulness institute for relaxation, meditation and rejuvenation/cleaning practices. This event was divided into a 3-days session program in which various renowned speakers from Heartfulness conducted the sessions and shared their experiences and wisdoms with us. Event was organized and volunteered by the members of the student body TAPAS-PCE. The event was conducted on an online platform- Zoom due to Covid-19 restrictions. The event was anchored by Resmi Ramakrishnan, BE- Computer Engineering student. The event commenced on 19th of October 2020 at 11:00 am for Batch 1 and 4:00 pm for Batch 2. Batch 1 included Information Technology, Computer, Electronics and Computer Science and Batch 2 included Mechanical, Automobile, Electronics and Telecommunication Engineering.



Inauguration of the event was done by Dr. Nivedita Shreyans, Director of Public Relations & Corporate Communications at MES, Dr.Sandeep Joshi, Principal-PCE, Panvel. The session for the first day was conducted by Mrs. Lalitha Rajagopal, Heartfulness Meditation trainer, Mr. Rajgopal Subramanyam, Heartfulness Meditation trainer and Mr.Pramod Sadar Joshi, CEO and Founder, Talent Smith Consultancy. The first day session was based on the basics of meditation and a talk on why to meditate followed by relaxation and meditation. The session was held for 1 hour.

The same schedule was continued for the following two days. On the 20th of October 2020, that is on the second day, the Cleaning process was the agenda of the session by Dr. Lalitha Dhareshwar, Ex. Sr .Scientist B.A.R.C and Mrs. Namrata Walvekar, Heartfulness Meditation trainer; followed by relaxation and meditation. Prayer was the agenda for the 3rd day, that is the 21st of October 2020, by Mr. Jayant Dhareshwar, Certified Spiritual Trainer and Ms. Saloni Godbole, Co. Founder and Director, Occamy Bioscience; followed by relaxation and meditation. At the end of each session there was an interaction round between participants and trainers for clearing queries about the session. More than 240 students were benefited by the event and we received a very positive feedback through a feedback form at the end of the 3 Day programme, the students were very satisfied and had an overall good experience. The three day event was an overall grand success.

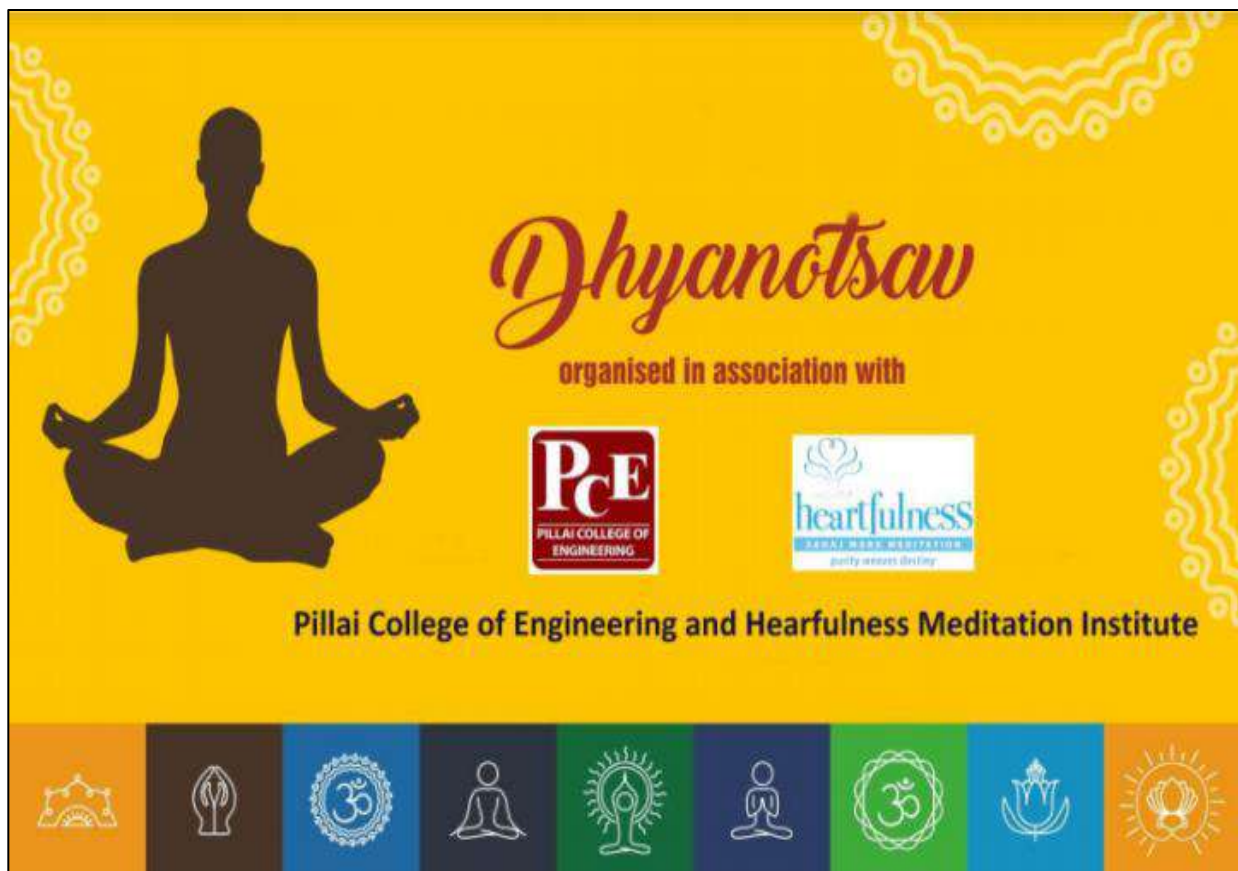

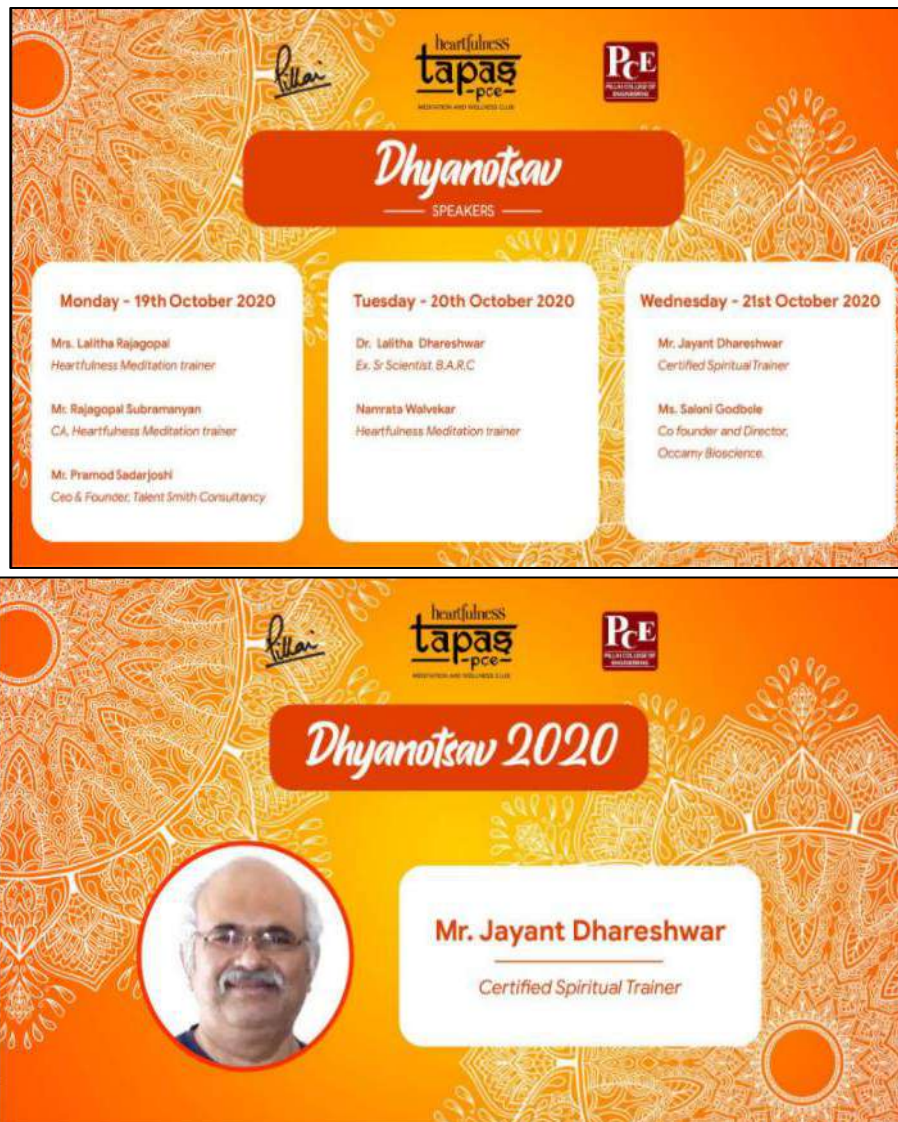

21 Days Meditation Challenge

“21 Days Challenge” is a very popular program under Heartfulness institute. This program was organized under TAPAS for all PCE students, faculty and staff. The program was organised from 1st March 2021 to 21st March 2021. Due to several requests it was made open for all. Total 173 registrations were received. Total 93 participants completed the 3 days of the event which were introductory sessions. Total 40 participants successfully completed the 21 Days Challenge. Participants were from various fields: students, faculty and staff of PCE and their family members, Students of other colleges, house wives, school teachers, police officers etc. attended and many of them successfully completed the program. On successful completion e-certificates were awarded to participants. The event was conducted on an online platform- Zoom due to Covid-19 restrictions. The event was hosted and conducted by the faculty of PCE Prof. Madhura



Vyawahare who is also certified trainer of Heartfulness institute for transmission based meditation.

Everyday evening 6.15 to 7.15 the sessions were conducted for all 21 days. In the session cleaning, relaxation and transmission based meditation were conducted and the last 15 minutes were for sharing feedback and doubt solving. Sessions were conducted by. Attendance was recorded by sharing google form and also using the automatic zoom platform. More than 80 participants benefited from the event and we received very positive feedback through a feedback form everyday. The participants were very satisfied and had an overall excellent experience. The event was an overall grand success.

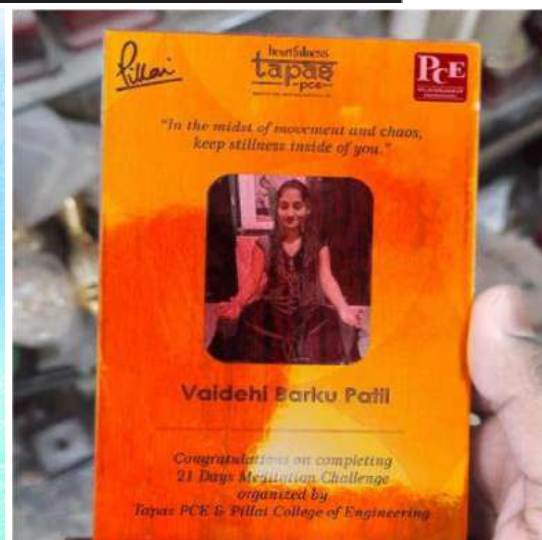

Photos of the event



NSS



The National Service Scheme is a Central Sector Scheme of Government of India, Ministry of Youth Affairs and Sports. It provides opportunity to the student youth of Technical Institution, Graduate and Post Graduates at College and University level of India to take part in various Government led community service activities and programs. The sole aim of the NSS is to provide hands on experience to young students in delivering community service. Prof. Bhagwan More, Assistant Professor, Department of Mechanical Engineering and Prof. Archana Ingole, Assistant Professor, Department of Applied Science, Mathematics and Humanities are the NSS program officers from Pillai College of Engineering, New Panvel.

Webinar on “How to Improve Concentration during Online Learning through Simple Yoga Activities”



On **25 July 2020** NSS-PCE arranged a yoga-based webinar in collaboration with Patanjali Yog Samiti. The speaker of the event was Mr. R. P. Yadav, Retd. Lt. Indian Navy and Jilla Prabhari, Patanjali Yog Samiti, Raigad District and was coordinated by Prof. Ravindra Nikam and Prof. Sonali Nikam. The event was attended by 450 participants, including students and faculty from PCE and outside. All the NSS volunteers were present in the event and ensured smooth flow. All the participants were awarded with a participation certificate.



Mahatma Education Society's
Pillai College of Engineering
 (NAAC ACCREDITED A+)
 Department of Applied Sciences, Mathematics and Humanities
 and
 NSS – PCE UNIT

WEBINAR
 "How To Improve Concentration During Online Learning
 Through Simple Yoga Activities."

In Association With
Patanjali Yog Samiti, Raigad District



Eminent Speaker
R.P. Yadav
 Retd. Lt. Indian Navy and
 Jilla Prabhari, Patanjali Yog Samiti,
 Raigad District.



CLICK ON LINK OR SCAN
 TO REGISTER
shorturl.at/bfyS1



NSS-PCE UNIT
 Event Coordinator
 Prof. Sonali Nikam
 9769610912
 smulik@mes.ac.in

 **25th July 2020**
 11.00 AM to 12.30 PM

E-Certificate will be provided to all Participants



Webinar on “Importance of Organ Donation”

PCE PILLAI COLLEGE OF ENGINEERING
A+ NAAC

MAHATMA EDUCATION SOCIETY'S
PILLAI COLLEGE OF ENGINEERING
NEW PANVEL, NAVI MUMBAI – 410206

**NOT ME
BUT YOU!**

Guest of Honour
Mr. Sudhir Puranik
Director
MU NSS Cell,
Maharashtra

On the auspicious account of **50th anniversary of NSS day** celebration we NSS PCE in association with VF Organs Foundation are arranging a webinar on “**Importance of Human Organ Donation**” on 24th of September 2020 @ 6pm IST. Certificate of attendance will be issued.

Speaker Aptekaka alias
Mr. Shrikant Murlidhar Apte
Member of Maharashtra State
Level Authorization

You can join the meet here @ 6 pm IST meet.google.com/uid-kgnvy-iez

[instagram.com/nss.pce](https://www.instagram.com/nss.pce) <http://pce.ac.in/nss> [Facebook.com/nss.pce](https://www.facebook.com/nss.pce)

On 24 September 2020, NSS-PCE in collaboration with VF Organs Foundation organised a webinar on “Importance of Human Organ Donation”. The speaker of the event was Mr. Shrikant Murlidhar Apte, Member of Maharashtra State Level Authorization. The Guest of Honour for this event was Mr Sudhir Puranik, Director of MU NSS Cell. Around thousand participants enrolled for this event, making it a huge success. All the NSS Volunteers were present in the event and made sure the event goes smoothly. All the participants were awarded with a participation certificate signed by the NSS-PCE Program officer, Principal of PCE as well as the speaker.

Webinar on “The Preamble – An Overview of thoughts of constitutionmakers of constitution of India”

On 26 November 2020 NSS-PCE in collaboration with NSS PCACS unit arranged a webinar on constitution day and its history. The speaker of the event was Ms. Gurpreet Kaur Khalsa, a motivational speaker. Dr. Sandeep M. Joshi, Principal, Pillai College of Engineering was invited as the Chief Guest for this event. The NSS volunteers ensured smooth conduction of this event. All the participants were awarded with a participation certificate signed by the NSS-PCE Program officer, Principal of PCE as well as the speaker.







MAHATMA EDUCATION SOCIETY'S
PILLAI COLLEGE OF ENGINEERING
PILLAI COLLEGE OF ARTS, COMMERCE AND SCIENCE
 NEW PANVEL, NAVI MUMBAI – 410206

Chief Guest : Dr. S. M. Joshi
 Speaker : Ms. Gurpreet Kaur Khalsa.
 A Motivational Speaker

On the auspicious account of **Indian Constitution Day** we NSS PCE in association with NSS PCACS are arranging a webinar on
“The Preamble - An Overview of Thoughts of Constitution Makers of Constitution of India”
 on 26th of November 2020 @ 6:30 pm IST.
 You can join the meet here : <https://pillai-edu-in.zoom.us/j/82682966349>
 Certificate of attendance will be issued.

 [instagram.com/nss_pce](https://www.instagram.com/nss_pce)
[instagram.com/pillaiscollege](https://www.instagram.com/pillaiscollege)
 <http://pce.ac.in/nss>
 [Facebook.com/nss.pce](https://www.facebook.com/nss.pce)

“Pledge Over Adapting Mandatory Precautions Against COVID-19”

On 8th October 2020, the volunteers of NSS-PCE took a pledge along with the program officer of NSS-PCE Prof. Bhagwan More. The pledge was about adapting to various community guidelines released by the government to fight against Covid 19 pandemic. For the Academic Year 2020-21, four events were organised under the guidance of Prof. Bhagwan More and Prof. Archana Ingole and the NSS volunteers attended six events organised under Mumbai University, other Higher and Technical Education Departments, Government of India, UNICEF and Rotary Club of India.

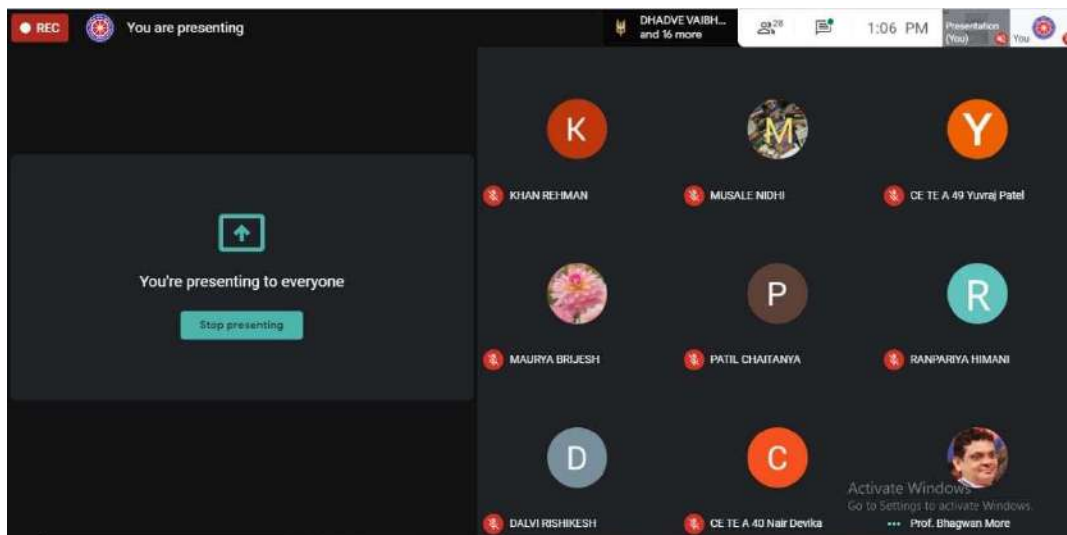



Events Attended by the Volunteers of NSS PCE

मुंबई विद्यापीठ

राष्ट्रीय सेवा योजना आणि
विद्यार्थी विकास विभाग
आयोजित

मुंबई विद्यापीठ
राष्ट्रीय सेवा योजना आणि
विद्यार्थी विकास विभाग
आयोजित

अवयव दान
जागृती कार्यक्रम

गुरुवार, दिनांक १३ ऑगस्ट २०२०, सकाळी ११:०० वाजता

निमंत्रण

• प्रमुख वक्ते •
श्री. श्रीकांत आपटे
मा. राज्यपाल नियुक्त सदस्य,
अवयव प्रत्यारोपण समिती, महाराष्ट्र शासन

• अध्यक्ष •
प्रा. सुहास पेडणेकर
मा. कुलगुरु, मुंबई विद्यापीठ

• सन्माननीय उपस्थिती •
प्रा. रवींद्र कुलकर्णी
मा. प्र-कुलगुरु, मुंबई विद्यापीठ
डॉ. विनोद पाटील
मा. प्रभारी कुलसचिव, मुंबई विद्यापीठ

• विनीत •
डॉ. सुनील पाटील
संचालक, विद्यार्थी विकास विभाग, मुंबई विद्यापीठ
श्री. सुधीर पुराणिक
संचालक, राष्ट्रीय सेवा योजना, मुंबई विद्यापीठ

कार्यक्रमास उपस्थित राहण्यासाठी खालील लिंक वर क्लिक करावे
https://www.youtube.com/channel/UCEHmEa3CDTRxc7OJznN_NVA

CLICK HERE



मुंबई विद्यापीठ

राष्ट्रीय सेवा योजना कक्ष, उच्च व तंत्रशिक्षण विभाग, महाराष्ट्र राज्य
राष्ट्रीय सेवा योजना आणि विद्यार्थी विकास विभाग, मुंबई विद्यापीठ
व युनिसेफ

यांच्या संयुक्त विद्यमाने आयोजित

सार्वजनिक आरोग्य संरक्षण व शासनाच्या सामाजिक योजनांबाबत प्रशिक्षण

रविवार, दिनांक १६ ऑगस्ट २०२०, दुपारी ४:१५ वाजता

विमंत्रण

उद्घाटक

मा. श्री. उदय सामंत

मंत्री, उच्च व तंत्रशिक्षण विभाग, महाराष्ट्र राज्य

सन्माननीय उपस्थिती

प्रा. सुहास पेडणेकर

मा. कुलगुरु, मुंबई विद्यापीठ

प्रा. रविंद्र कुलकर्णी

मा. प्र.कुलगुरु, मुंबई विद्यापीठ

डॉ. विनोद पाटील

मा. प्रभारी कुलसचिव, मुंबई विद्यापीठ

डॉ. अतुल साळुंके

मा. राज्य संपर्क अधिकारी व विशेष कार्य अधिकारी,
राष्ट्रीय सेवा योजना कक्ष, उच्च व तंत्रशिक्षण विभाग, महाराष्ट्र राज्य

विनीत

डॉ. सुनील पाटील

संचालक, विद्यार्थी विकास विभाग,
मुंबई विद्यापीठ

श्री. सुधीर पुराणिक

संचालक, राष्ट्रीय सेवा योजना,
मुंबई विद्यापीठ



CLICK
HERE

कार्यक्रमास उपस्थित राहण्यासाठी खालील लिंक वर क्लिक करावे
https://youtu.be/auBHe1E_t6k





Global Handwashing Day (GHD), October 15th

My Family My Responsibility



National Service Scheme, Higher and Technical Education Department, Government of Maharashtra, UNICEF and Rotary Club of Bombay West

October 13th, 2020: 10.45 to 12.40 Hrs

Time	Topic	Facilitator
1100 - 1105	Welcome and Introduction	Dr. Atul Salunkhe State Coordinator, NSS, GoM
	Inauguration & Keynote	Hon. Uday Samant Minister, Higher and Technical Education Department, GoM
1105 - 1130	Role of NSS Volunteers	Dr Kamal Kumar Kar, Head, Directorate of NSS, New Delhi
	Global Handwashing Day & Week	Smt. R Chandrasekar Chief, UNICEF Maharashtra / Shri Yusuf Kabir WASH Specialist, UNICEF
1130 - 1145	Handwashing: Need & Relevance	Dr Rajendra Awate Public Health Expert, Pune
1145 - 1200	Handwashing: Technologies	Shri Anand Ghodke WASH Officer, UNICEF
1200 - 1215	GHD 2020: Competitions	Mr Apurva / Shri Rajendra Ruia Rotary & Rotaract Club
1215 - 1230	Guidance on Audio-Visual Presentations	Ms. Wendy D'costa WIFA, Mumbai
1230 - 1235	Summing Up	Shri D Carthigueane Regional Director, NSS, GOI
1235	Vote of Thanks	Ms. Swati Mohapatra, Communication Specialist, UNICEF

Virtual Session for National Service Scheme Directors, Coordinators, Program Officers & volunteers

Supported By:







<https://youtu.be/wOA2VjjFDN0> link for NSS volunteers to join



मुंबई विद्यापीठ



वैष्णव जन तो तेने कहिये जे,
पीड परायी जाणे रे...



मुंबई विद्यापीठ
राष्ट्रपिता महात्मा गांधी जयंती
माजी पंतप्रधान लाल बहादूर शास्त्री जयंती व
जागतिक अहिंसा दिनानिमित्त आयोजित



भजन संध्या

शुक्रवार, दिनांक २ ऑक्टोबर २०२० • संध्याकाळी ५:०० वाजता

• प्रमुख पाहुणे •

दिलीप प्रभावळकर
सुप्रसिद्ध अभिनेते

श्रीधर फडके
सुप्रसिद्ध संगीतकार

उस्ताद तौफिक कुरेशी
सुप्रसिद्ध संगीतकार

गीतिका वर्दे कुरेशी
सुप्रसिद्ध शास्त्रीय गायिका

किशोर कदम
सुप्रसिद्ध कवी आणि अभिनेते

• अध्यक्ष •
प्रा. सुहास पेडणेकर
कुलगुरु, मुंबई विद्यापीठ

• सन्माननीय उपस्थिती •
प्रा. रविंद्र कुलकर्णी
प्र कुलगुरु, मुंबई विद्यापीठ

• विनित •
डॉ. विनोद पाटील
प्रभावी कुलसचिव, मुंबई विद्यापीठ

• आयोजक •
विद्यार्थी विकास विभाग, राष्ट्रीय सेवा योजना कक्ष,
आजीवन अध्ययन व विस्तार विभाग,
संगीत विभाग, मुंबई विद्यापीठ-व
मुंबई विद्यापीठाचे आजी-माजी विद्यार्थी

विमंत्रण



CLICK HERE

कार्यक्रमास उपस्थित राहण्यासाठी खालील लिंक वर क्लिक करावे
<https://www.youtube.com/channel/UCNQQByo2cn85ijVt2bf07pw>



शिवस्वराज्य दिन सोहळा
रविवार, दि. ६ जून २०२१, स. ११.०० वा.

मा. ना. उदय ठाकरे
मुख्यमंत्री,
महाराष्ट्र राज्य

मा. ना. अनिलदादा पवार
उप-मुख्यमंत्री,
महाराष्ट्र राज्य

मा. ना. उदयजी सामंत
मंत्री उच्च व तंत्रशिक्षण विभाग, महाराष्ट्र राज्य

प्र. विठ्ठल मजुबरे-पाटील
विशेष आचार्य

अध्यक्ष: उच्च व तंत्रशिक्षण विभाग, महाराष्ट्र राज्य
विषयक: अभिषांत्रिकी महाविद्यालय पुणे

मुंबई विद्यापीठ

मुंबई विद्यापीठ
बाळासाहेब ठाकरे
अध्यासन केंद्र

नि मंत्र ण

आदरणीय
बाळासाहेब ठाकरे
स्मृतिदिनानिमित्त
आयोजित कार्यक्रम

प्रमुख पाहुणे
श्री. उदय सामंत
मा. उच्च व तंत्र शिक्षण मंत्री, महाराष्ट्र राज्य

सन्माननीय उपस्थिती
श्री. रविंद्र वायकर
मा. माजी उच्च व तंत्र शिक्षण राज्यमंत्री, महाराष्ट्र राज्य

डॉ. स्नेहलता देशमुख
मा. माजी कुलगुरू, मुंबई विद्यापीठ

विजित
प्रा. सुहास पेडणेकर
मा. कुलगुरू, मुंबई विद्यापीठ

प्रा. रविंद्र कुलकर्णी डॉ. विनोद पाटील
मा. प्र कुलगुरू, मुंबई विद्यापीठ प्राभारी कुलसचिव, मुंबई विद्यापीठ

स्मृतिगंध

मंगळवार, दिनांक १७ नोव्हेंबर २०२०
वेळ: सायंकाळी ५:०० वाजता

कार्यक्रमात सहभागी होण्यासाठी खालील लिंकवर क्लीक करावे

<https://www.youtube.com/channel/UCNQ8yo2cn85jV12bf07pw>

CLICK HERE



SWE

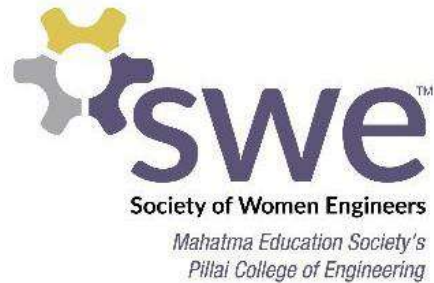

Society of Women Engineers Mahatma Education Society's Pillai College of Engineering Affiliate (SWE PCE) is an official Society of Women Engineers (SWE) Global Affiliate Group, and connects to more than 70 SWE affiliates around the world. The mission of the recognized Affiliate group is to empower women to achieve full potential in careers as engineers and

leaders, expand the image of the engineering profession as a positive force in improving the quality of life, and demonstrate the value of diversity and inclusion. SWE PCE Affiliate was installed on May 13, 2021 in the presence of Paul Robichaud, Managing Director, Society of Women Engineers, India Sunayana Reddy, Admin and Communications Manager, Society of Women Engineers, India Principal, PCE and The Management Board, Mahatma Education Society. The participants were given an overview about Society of Women Engineers, its goals, core values and benefits.

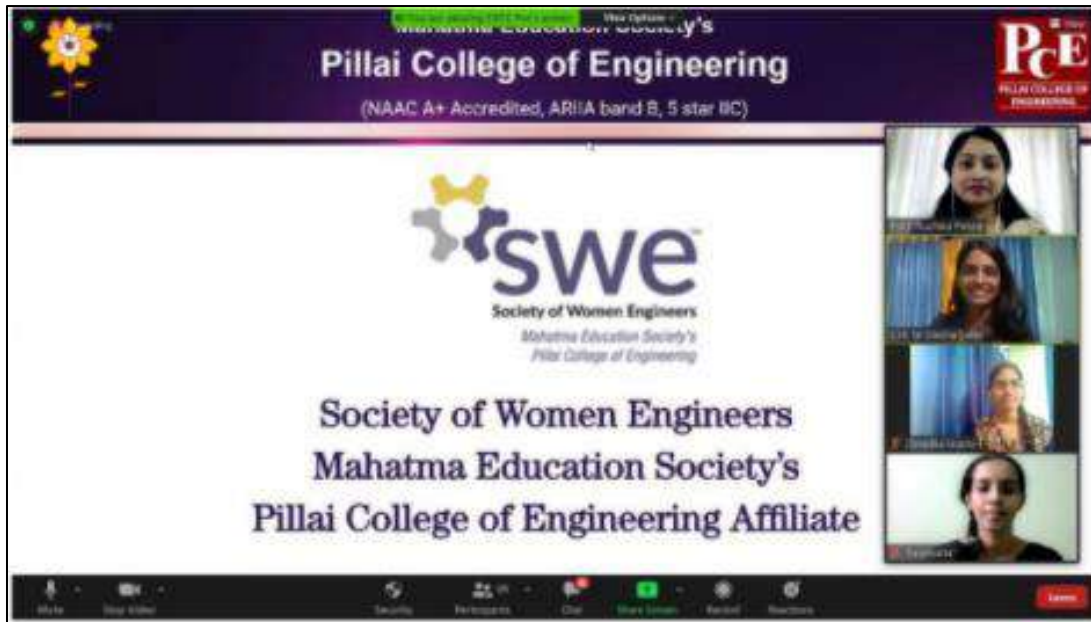

Interactions of the SWE Members during the ceremony



Mr. Paul Robichaud, Managing Director, Society of Women Engineers, India, addressing the participants

Extra Curricular Activities

Independence Day



Inspite of the Pandemic, Independence Day was celebrated by hoisting the National Flag on 15th August in the presence of very few members and **maintaining** proper norms. But on the occasion of the 74th Independence Day, the Training and Placement Committee of Pillai College of Engineering organised a webinar on "Induction into The Indian Army - Officer Cadre (For Men & Women)". The speakers for the webinar were Col. Arun Malhotra (retd), Ms. Ruby Talukdar and Capt. Supriya Patil (retd). The topics discussed were Modes of Entry in the Army, Examinations & Selection Procedure, Psychological & Physical Requirements, Entry Scheme for girls in the Armed Forces and Training Academies.

Teacher's Day

Mahatma Education Society's Pillai College of Engineering celebrated Teacher's Day on 6th of September. The Student Council organised the whole event with the help of other committee heads and the event was conducted on the Google Meet platform. All the faculty members were sent invitations for the celebration.

The event began with the introduction speech by Miss. Nupur from TPC committee and Mr. Shabrish from the ISHRAE committee gave brief information about the life of Dr. Sarvepalli Radhakrishnan. Then our college band, Benchmark performed, dedicating all the songs to all the teachers. This was followed by a very fun interaction session where Miss. Nivedita from ETSA committee asked our teachers to share some experiences about their life as a student and also about their favourite teachers. We asked some of our faculty members to showcase their talent where Madhura Ma'am read a Marathi poem and Jagdish Sir played bansuri. This was followed by a video which was about our past alumni sharing their experiences related to our teachers and giving them teacher's day wishes. The result of favorite faculty from every department was declared and the winners were, Prof. Dr. Onkar S. Sahasrabudhe from Mechanical department, Prof. Aju Palleri from Information Technology department, Prof. Ishmeet Riar from Electronics and Telecommunication Engineering department, Prof. Swati Patil from Electronics and Computer Science department, Prof. Amey P. Marathe from Automobile department, Prof. Ranjitha Gaonkar from Computer Engineering department and Prof. Dr. Sachin S. Wani from the Applied Sciences & Humanities department. The second video was played in which all the committee heads shared their emotions for their faculty members. The event came to an end and Miss. Gauri from AESA MESA gave a vote of thanks to all the teachers. After the event, each and every faculty member was sent a personalised thank you note to offer sincere Gratitude.





Invitation

Dussehra

Dussehra, also called Vijayadashami, symbolizes the victory of good over evil. Dussehra is celebrated on the 10th day of the month of Ashvina which is also the tenth day of the Durga Puja. It is a tradition of PCE to celebrate Dussehra every year. It is a tradition to worship all the new equipment on the day of dussehra which is followed in all departments of PCE. Every laboratory is decorated with rangoli and flowers and pray for all wellness, health and wealth. Due to the pandemic and lockdown not all members were gathered but by following all rules stated by the government, we had a small gathering and worshiped for growth of all members of PCE family and organization. The puja was done on 24th October. Event was of around two hours which started at 11am.

Few glimpse of the event:



Department of Mechanical and Automobile Engineering



Department of Computer Engineering and Information Technology

Drishti - The Unseen Vision

Drishti - The Unseen Vision Webinar was organised on 23rd January, 2021 by Pillai College of Engineering, . The webinar was held online for all the students of the college. This event was organized for the celebration of 124th Birth Anniversary of Honorable Netaji Subhash Chandra Bose reminiscing his persevering contribution to our nation. All the teachers and student bodies came together to organize various fun competitions like Poster Making, Sketching, Debate, General Knowledge Quiz, Essay Writing, Poetry Writing, and Short Video Competition. Circulation of Posters and messages were done to ensure that the students could get to know about the event and the competitions. The Quiz Competition began at 10 AM, which was continued with the Debate competition in the afternoon. Students who wished to participate in various competitions showed up in considerable numbers.

The webinar started at 2 PM which was conducted on the Zoom platform as well as live-streamed on Youtube. The webinar started with an introductory speech by the Principal of PCE, Dr. Sandeep Joshi. The speakers for the session were Saloni Gharge, Vaishnavi Garad, and Bhushan Pradhan who talked on Netaji's early life, his education, his thoughts on Science and Technology, Women Empowerment, his ideologies, his objectives and strategies of forming parties, his legacy and most importantly his dedication for our India's freedom movement. The session concluded by felicitating the winners of various competitions and with this the event came to an end at 3.15 PM. Certificates for all the participants were sent via email by 24th January 2021. The entire program was coordinated with the support of the principal Dr Sandeep Joshi and the faculty members of Pillai college of engineering, New Panvel, Navi Mumbai. Student Council along with all student bodies like CSI PCE, IEEE PCE, ETSA, ISHRAE, AESA MESA helped to organise this successful event.

Event Flow

Time	Event
10:00 AM	Quiz Competition
12:00 PM	Debate Competition
2.00 PM	Webinar
3.15 PM	Felicitations and Vote of Thanks

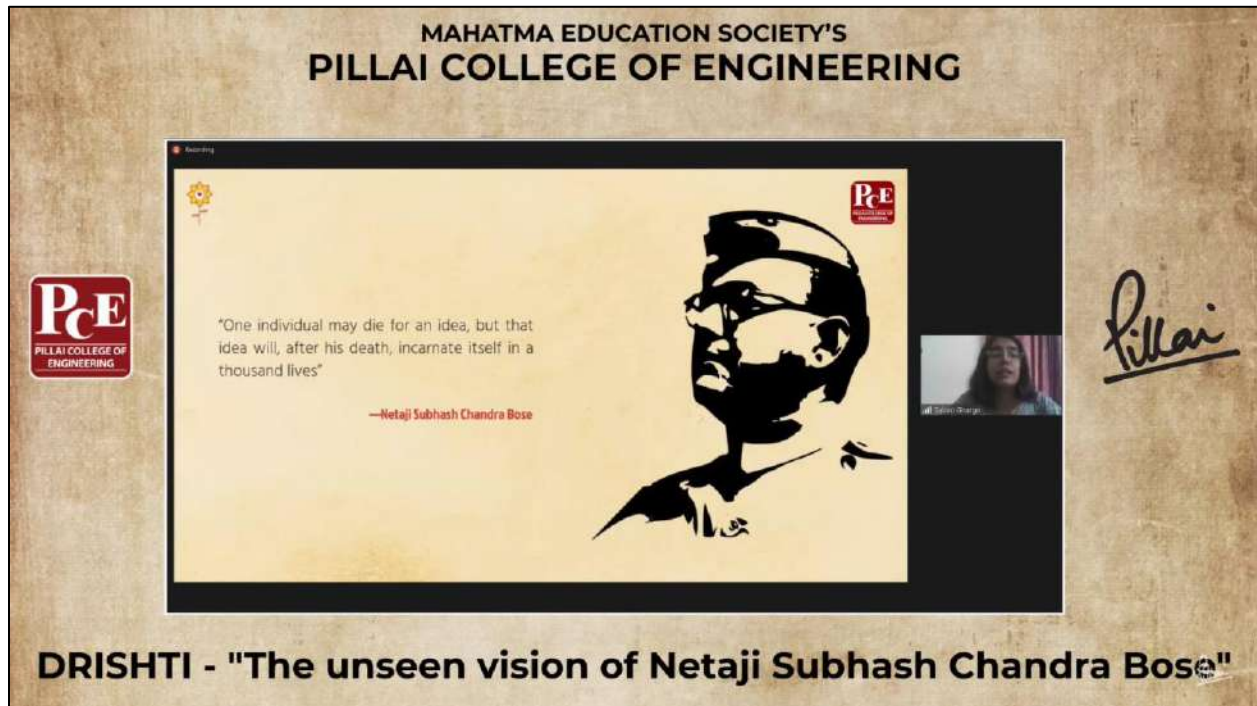

Saloni Garge



Short Video Competition Winners

Republic Day



Republic Day was celebrated on 26th January at 8.00pm by hoisting the National Flag. Mr. Pragnesh Shah, Associate Professor, Electronics and Telecommunication Engineering was the chief guest for the occasion. The event started by hoisting the flag followed by the address of the chief guest to the gathering. Only a limited no. of attendees were present due to the pandemic situation. The occasion concluded with the National Anthem.

Utsav Majhya Rajanacha: Shivaji Jayanti

Pillai Group of Institutes came together to celebrate the birth anniversary of Chhatrapati Shivaji Maharaj /Shivaji Jayanti on 20th February. The objective of celebrating the Shiv-Jayanti festival is to remember the innumerable qualities of Chhatrapati Shivaji Maharaj, like Efficacious organizer, Strategic Visionary, Great warrior, Enlightened administrator, Inspiring leader and Obedient son and many more.



This year's celebration marks the 391st birth anniversary of the great Maratha warrior. The celebration started with the pooja of the idol by the faculty members and the day was enthusiastically celebrated with various cultural programs like speeches and the Dhol Tasha Pathak to reminisce and to create awareness in the young minds of the students regarding the valiant Maratha warrior, Shivaji Maharaj. All the covid-19 pandemic regulations were followed throughout the event. The day ended with much pomp and vigor leaving everybody with a sense of pride and respect for the great Maratha ruler and his inspiring endeavors. The event was well organized and it was truly memorable.

Alegria - The Festival of Joy

This year Alegria 2021 Banner unveiling ceremony was organised with a captivating flashmob where talented dancers performed for the excited crowd on 28th February 2021 in Dr.K.M.Vasudevan Pillai Campus. After such enthralling performances by the dance crews, RTN and Alite the banner was unveiled in the most fascinating manner. Even though Alegria was online this year, hype was still the same. Shining through the darkness of the unprecedented times and bringing light in each and every Alegrian's life, Alegria 2021 raised the bar higher than ever!



Flashmob & Banner Unveiling

Alegria-The Festival of Joy is the Pillai Group of Institutions exciting intercollegiate event organised in Dr. K.M.Vasudevan Pillai Campus by students of all the institutes in the campus i.e. Pillai College of Engineering, Pillai College of Arts, Commerce and Science, Pillai Institute of Management Studies and Research and Pillai College of Architecture from 4th March to 7th March 2021.

The inauguration of the annual festival of Pillai College, Alegria-The Festival of Joy 2021 was presided by the principal of PCE, Dr. Sandeep Joshi, and the vice-principal of PCACS, Mrs.Deepika Sharma. The auspicious morning began on a bright note with a soul-soothing yet

energetic singing performance by The Playlist band from PCACS. This was followed by a dazzling dance performance by the two very amazing dance groups of Pillai College, RTN, and Alite. The inaugural session also involved an electrifying performance by the most glamorous group, Uconic. It ended beautifully with Dr. Daphne Pillai enlightening everyone with her motivational speech, encouraging the audience to spread light in these difficult times.



Inauguration Ceremony

The first event of Alegria was Classical Solo Dancing. The event was judged by the very talented and graceful, Prachi Devdhar. The participants set the stage on fire with their mesmerizing performances. Her elegant moves left the crowd astonished and their hearts were full of her shining aura.



Prachi Devdhar - The Judge for Classical Solo Dancing & Ms. Soundarya Sharma with Mr. Alegria

The last event of the day, Mr. And Ms. Alegria, started on a high note where we welcomed the judge, the very beautiful Actress Ms. Soundarya Sharma. The event kicked off and the participants didn't fail to leave the audience in awe after their performances! The moment Soundarya stepped on stage, the crowd started grooving with her and within minutes everyone was on their feet swaying together along with the beats.

The 2nd day began with Freestyle Solo Competition and the whole mood of the festival was stirred up by it. We got to see some really breathtaking powerhouses of talent which were judged by none other than our alumni, Immanuel John and his classic performance at the end left the crowd fascinated. The whole auditorium was at a whole new level of enthusiasm to have the rappers, Aby Thampi and Raptonicz crew as a judge for the Rapping Session. The competition helped discover some very skillful talents and all the contestants charmed the audience with their stunning rapping skills.

While the Freestyle Solo and Rapping took the bar of excitement higher and higher, the day was also jam-packed with numerous fun-filled events right from Informals to Literary Arts, Management to Technical and Gaming to Sports.

Starting the 3rd day with the beatboxing competition the whole auditorium was grooving to each beat. Having such talented artists beatbox such difficult yet smooth beats left us dumbfounded. Not only was that but the contestants hyped to a great extent for they were going to be judged by 2018 Indian beatbox champion - Anup Gaikwad. He was also in the top 16 of Asia champs. Having him on campus surely set the bar high for the coming events.



Aby Thampi and Raptonicz Crew



Winner of Rapping Session

Just as the atmosphere was heating up, we had the stunning cast of the hit song 'Dil tune toda hai' as guests. The gorgeous Muskan Sharma, Sana Khan, and Sapna Gill along with the dashing Amardeep Phogat graced us with their presence. Amardeep Phogat showed off some of his fitness skills and wowed the entire crowd. Never had we seen someone so strong and fascinating.



Muskan Sharma, Sana Khan, Sapna Gill and Amardeep Phogat and Danish Alfaaz - Judge for Face of Alegria

Next in line was the Face of Alegria, one of the biggest events of Alegria. Not only pretty faces but sharp minds are found here. The walk, the talk, and the talent, all are taken into consideration while judging but we didn't have to worry about that as we had the talented singer/songwriter/actor Danish Alfaaz as the judge for the event. With his new release, 'Party Ho Rahi Hai' the whole auditorium was getting on with the rhythm. Pillai's crowd surely is gonna make it their new party anthem.

With such an energy-filled day, it was a promise for an even better next day. With each moment each person experienced the best time of their lives, letting go of all worries and just going along the Alegrian vibe ended another day.



Razik Mujawar



Token of love from students to Razik Mujawar

The fourth and the last day of Alegria was filled with mixed emotions of equal parts excitement, nostalgia, and sadness because the mind-blowing festival was finally coming to its end. Some

say Alegria is not a festival, but a feeling and this feeling was kept alive this year even though all the hurdles we have faced. What appeared to be a pipe dream was made into reality by the determination and hard work of all Alegrians and each day of the festival seemed to be more thrilling than the last one and the final day continued this trend exponentially! The day commenced with the Solo Singing Competition. The auditorium was filled with the profound and passionate voices of the participants and their unbelievable talents. The judge for the event was the amazing Razik Mujawar who sang a few covers and original songs for the audience, lifting everyone's spirits and bringing an unmatched lightness to everyone's mood.

Next in line was the Mono Acting competition in which participants acted as multiple characters, lighting the auditorium with the emotions and feelings they were portraying through their characters. The audience really connected with their renditions. The judge for the event was the incredible Livon Times Fresh Face season 11 winner Afzal Siddiqui and he brightened the occasion with his presence and insight!



Afzal Siddiqui and Anuj Mishra

The final event of Alegria was the highly anticipated Duet Dance completion. Pairs of dancers on the stage appeared to be single units, perfectly in sync with one another, performing amazing choreographies. The judge for the event was none other than Anuj Mishra, who has choreographed for celebrities like John Abraham, Sonakshi Sinha, and Sushant Singh Rajput!

Alegria - The festival of joy brought light to the dark and dull times we had all been living it. It came as a blessing and departed by becoming a memory that will hold a special place in our hearts forever. We are all going to be counting days until the upcoming Alegria!

International Women’s Day

ETSA PCE organized an event to celebrate “Women’s Day”. International women’s day is celebrated on 8th March every year. It is a focal point in the movement for women’s rights. It is observed around the world to celebrate the velour of women. The celebration was held on 7th March for the teachers of Electronics and Telecommunication Engineering and Electronics and Computer Science Department. The event started at 11:10am by the anchors with a warm welcoming message. ETSA members had recorded special video messages for all the teachers and a video montage of those was played initially. A variety of games were arranged for the teachers out of which the first game was “Bollywood Puzzler”. The game required teachers to guess the name of the character and the movie by looking at various PPT slides. Richa Ma’am emerged as the winner of this game. Bollywood Puzzler was followed by a beautiful poem recited by ETSA representative Divya Wairkar. Soon after this, the teachers were engaged in an interesting “Rapid Fire” game.

After the Rapid fire round, a video was played which reminded everyone of the memories of previous years Women’s day celebrations by ETSA. The inability to communicate in a close, warm environment due to the COVID-19 pandemic was ruled by one and all. Next up was a game called “Riddles" wherein teachers had to read the riddles displayed on the screen and post their answers in the chat box. The game ended in a tie for 1st position between Richa Ma’am and Apeksha Ma’am. Finally, the teachers were requested to participate in a short game of Antakshari with songs across generations being sung by everyone. Women’s Day is one of the most important events that ETSA conducts every year. There is absolutely no better way to celebrate the contribution of women in our lives & all the members of the committee pride themselves on being a part of such an event. We look forward to bringing such joy into our teacher’s lives next year too as we take back some wonderful memories with us from this year’s event.

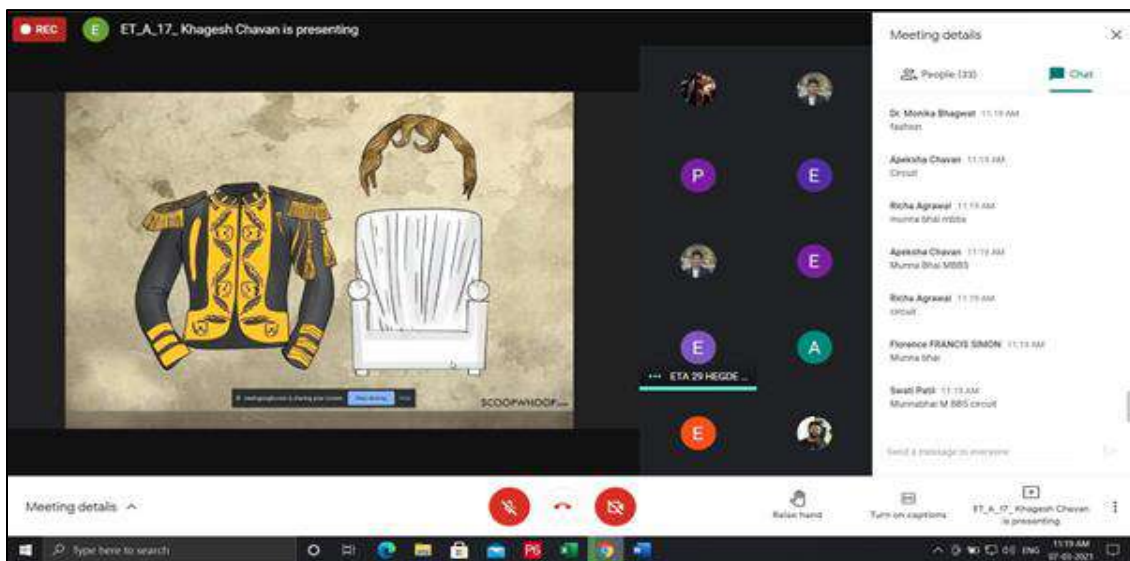

Slide regarding “Bollywood Puzzler

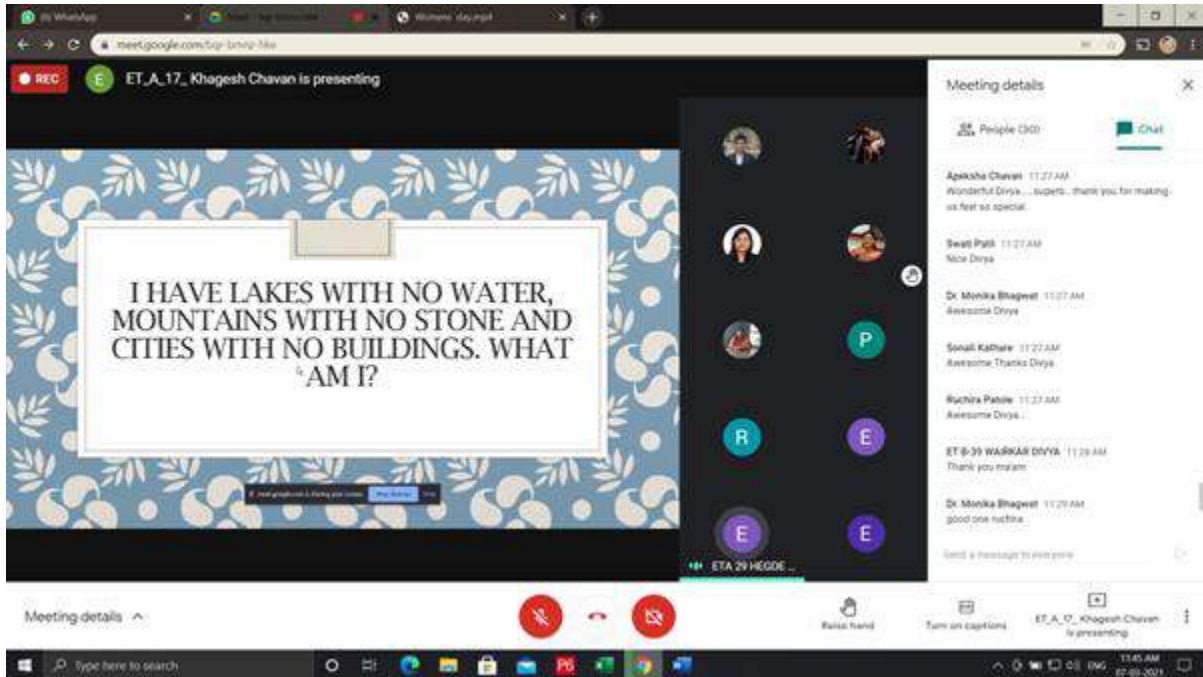

One of the slides showcased during the “Riddles” game

Social Events

What's Next Post COVID



MAHATMA EDUCATION SOCIETY'S
PILLAI COLLEGE OF ENGINEERING
 IN ASSOCIATION WITH
PILLAI ALUMNI ASSOCIATION

DARYL MATHEW
 PCE ALUMNI - 2004 BATCH (ELECTRONICS)
 Aryaka Networks : Director- Global Service Delivery

WHAT'S NEXT POST COVID

Discussion Points:

- * Current state of the world.
- * Past disruptions & opinions on the future.
- * Emerging trends.
- * Way forward to be future ready.

LIVE WEBINAR | **18TH JULY** | 11:00 AM - 12:00 NOON (IST)
 SATURDAY

PCE ALUMNI ASSOCIATION organized the talk on a very demanding question of today's times, "What's Next Post COVID?" on 18th July 2020. The speaker for the webinar was Mr. Daryl Mathew, alumni of Pillai College of Engineering. It was free for all participants aimed at making the attendees aware of the current situation of the era and what next. The webinar was attended by 109 students, 14 faculty members and 5 alumni.

The webinar was graced by the presence of Principal Dr. Sandeep M. Joshi, Head of the department of Computer Science, Dr. Sharvari Govilkar and Head of the department of

Information Technology, Dr. Satishkumar L. Verma and respected faculty members from all the departments.

The webinar started with our speaker Mr. Daryl Mathew. He discussed the points listed below:

- Current state of the World
- Past disruptions and opinions on the future
- Emerging trends
- Way forward to be future ready

The webinar proved to be a place for all the students to find better solutions regarding life post COVID. The event was successful and interactive where students asked a number of questions and the speaker could clear all the doubts. It was enough to attract as many as 100+ students and 10+ faculty members. After the wonderful question answer session, the students were quite happy by the talk given by their alumnus. The speaker was given a vote of thanks along with the Principal sir and the faculties. All the dignitaries thanked the speaker and spoke some words of encouragement for all the students participating. The webinar was finally concluded by appreciating the efforts of the organizers.

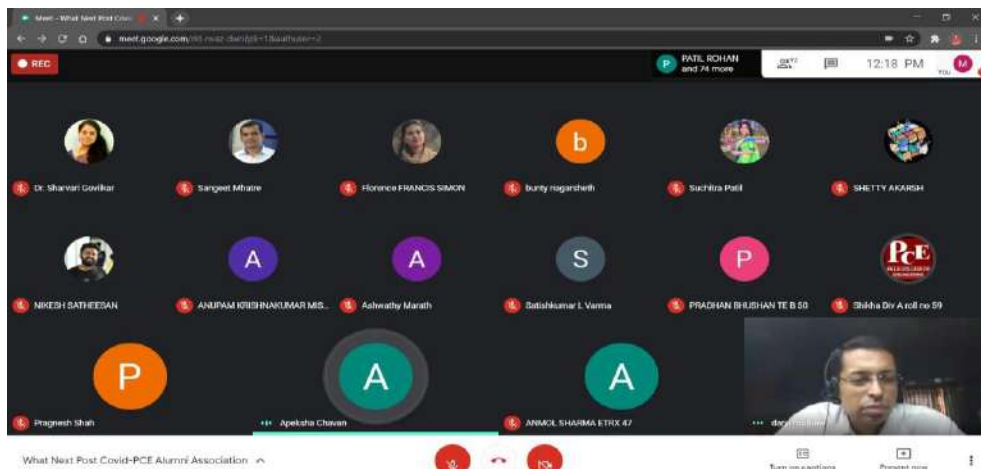

Daryl Mathew Addressing the Students

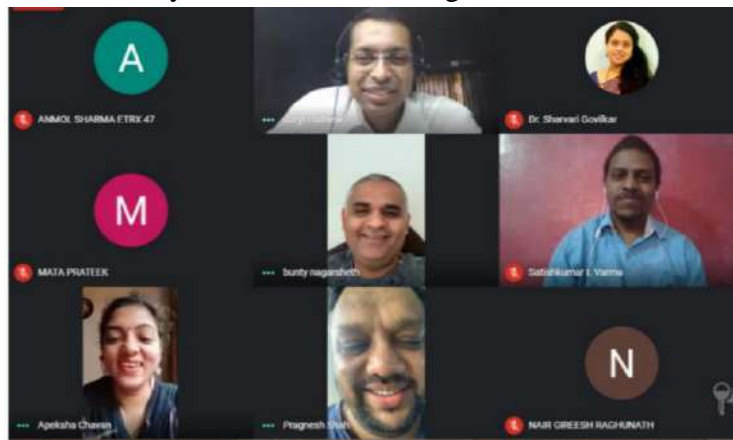

Group Online Photos

Garage Sale

Garage Sale was organised on 6th February'2021 in the Workshop Premises which was open for all our Faculties, Non-Teaching Staff and students. There was a good response from faculties and Non-Teaching Staff. One day all together collection was Rs.11,600.00 (Rupees Eleven Thousand and six Hundred only). The money was deposited in Accounts Office. Cherava and stool were the items kept for sale. All the items mentioned were made by First Year (FE) students as part of their first semester basic workshop practices.



Atma Nirbhar

Event date and time: 1st August 2020, 5PM to 8PM

PCE Alumni Association organized a webinar for students to become “Aatmanirbhar” during these tough times by learning about various challenges across different industries. The webinar started with a brief introduction about “Aatmanirbhar” and how it was conceptualized by Mrs. Richa Rupani and Mrs. Sharmaine D'souza associates of Inventor Network who got inspired by our honourable PM's speech. Further the speakers enlightened the various challenges faced by different industries and its impact on the country's economy. Investor networks, as said by Haque Mobassir, promotes the concept of innovation. They work on the thought process that enables innovation. They have an engineering method that triggers the thought process in the right direction in any innovative field. It is about promoting the innovative mindset and integrating it with growth. Mr. Kumar Gaurav (Top 50 Tech Innovator in U.K. CEO Cashaa) has worked for automobile companies like Ferrari, and currently is the CEO of Cashaa. He started off by saying that innovation is a fancy word yet confusing. He along with some examples stated

the meaning of radical innovation i.e. the innovation seems senseless until its true use is put to work. The entire webinar was a success. Students met their expectations and learned a lot about the different industries and how they work. There were ideas that are going to help the students’ design their path towards their goals and to help them stay motivated all the way.



Kumar Gaurav Addressing the Students

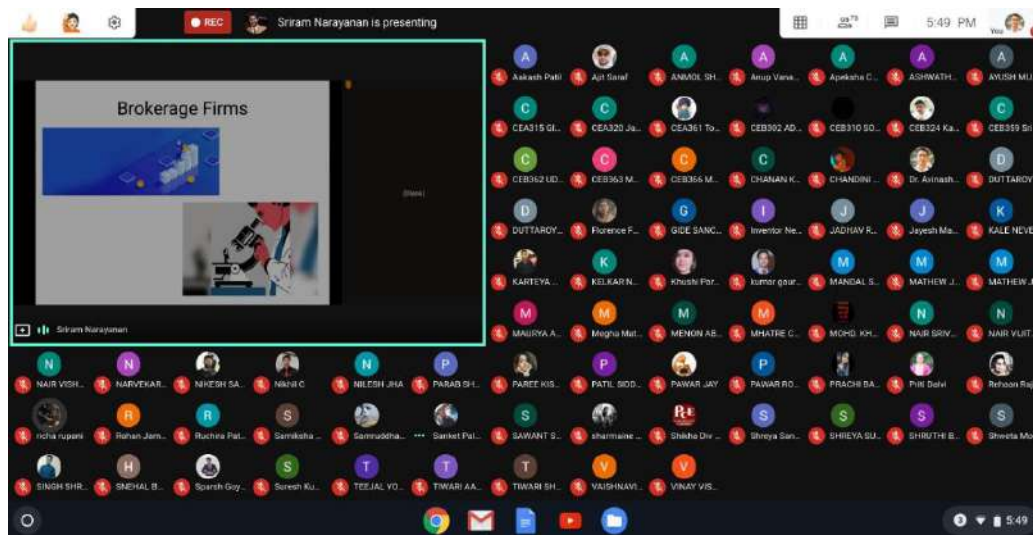

Some Glimpses of the Event

Community Service Day

Blanket Donation Drive

Unfortunately, this year Mahatma Education Society was not able to observe 'Community Service Day' at Dr. K. M. Vasudevan Pillai Campus, Panvel due to the pandemic. To observe Community Service Day in 2021, a collection drive of old/new blankets, pillows, sweaters, warm clothing, etc. was conducted in the month of January 2021. The winter was brutal this year and thousands of homeless people experienced severe illness due to the lack of shelter and warm clothing. Hundreds of people became victim of this phenomenon. The bitterness of winter affects a vast majority of population in ways unimaginable to the comforts of our living rooms. Institute felt that conducting this drive was the least that could be done to help those on the streets.

The MES team distributed the items personally to the homeless in the last week of January 2021 in the areas of Mumbai & Navi Mumbai. MES is grateful to all our students and faculty who supported this cause by donating everything they could spare. We are sure that this drive helped these individuals in some small capacity.

Some Pics of the Drive:







SANMATI 2021 – A webinar on Universal Human Values

Date : 28th and 29th of June

SANMATI 2021 a webinar on UNIVERSAL HUMAN VALUES was held on the 28th and 29th of June 2021. This program was organised by the Dept. of Applied Sciences, Mathematics and Humanities. Prof. Dr. Arun Pillai HOD of first year was the Co-ordinator for this event. The organising committee included Dr.Surabhi Singh, Dr. Malavika Sharma, Prof. Darshana P and Dr.Sundeep Deulkar. The Technical assistance was provided by Prof. Anup Vanage. The event duration was for 2hours. On the first Day i.e. 28th of June FE divisions A, B, C and D participated. FE divisions E, F, G and H participated on the next day i.e. the 29th of June. The webinar aimed to evoke the Human values amongst all of us, which are otherwise lying dormant. This is one class where we all are learners and we learn from each other's experiences. Principal Dr.Sandeep Joshi commenced the session on both the days with his relevant anecdotes. In his speech Dr.Sandeep Joshi sir emphasised that we can only evoke the Human Values, but the implementation should be done by every individual. The entire session comprised of four modules each covering one human value-Respect, Love, Kindness and Empathy. The module on the Human value of RESPECT was conducted by Dr.Surabhi Madam. The session started with a relevant video, followed by a word cloud quiz wherein the participating students had to identify the HUMAN VALUE depicted in the video. This was followed by experience sharing of two preselected students on the topic of RESPECT.

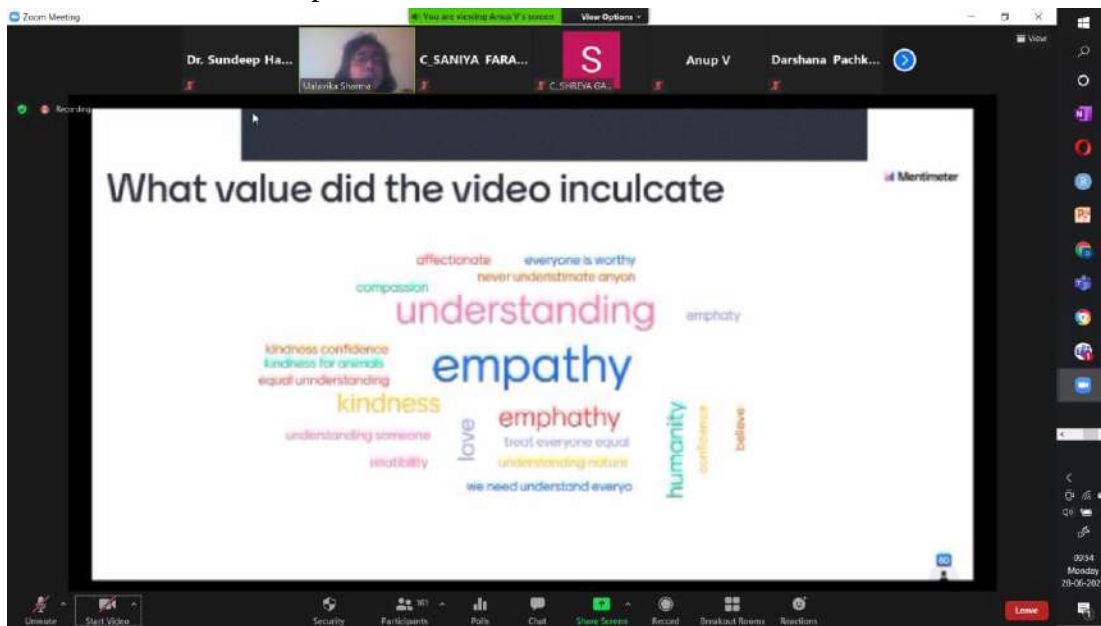

Mentimeter Word Cloud output for the module on EMPATHY conducted by Dr. Malavika Sharma.

Upon summarizing the experiences of the 2 students, a situation based opinion poll was conducted for all the audiences. The same sequence was followed for other Human Values Viz.

Love , Kindness and Empathy. Participating teachers and class co-ordinators too shared their experiences on this occasion. On each day the session ended with a small prayer: Ishwar Allah Terey Naam Sabko Sanmati De bhawgan. This aptly summarises and reinforces the name SANMATI 2021 for the Webinar.

Dog Feeding Drive

COVID-19 pandemic has brought a very difficult time upon our lives. While humans can find a way to keep themselves free from hunger, animals are helpless. Looking at this, as a part of the annual fest of Mahatma Education Society's Pillai Institutes, the student council and the Alegria committee organised a Dog Feeding Drive as an initiative towards the welfare of stray dogs in the month of February.



Preparing Packets



Feeding to Dogs

A dog feeding program was arranged which was seen in many places where students themselves went with food packets for stray dogs. Those who couldn't lend their hand in this activity donated an amount of their choice to help our students buy food for them. People from all over Maharashtra donated for this drive along with feeding stray animals near their residential areas. Many students came together to commence this cause, the proper social distancing guidelines were followed by each person. Finding strays on each turn, corner, compound and area, each was offered food. It is said that a dog is a man's best friend and this was a chance for the students to prove that along with dogs, humans can be too. Grasping the opportunity, students fed dogs across Mumbai and Navi Mumbai. Slowly but steadily this program expanded and numerous dogs went to sleep with a full and satisfied appetite.

Workshop on Youth health and Mind Management

Event Date: 22nd March to 25th March 2021

Resource Persons: Maheshwari Narayanan and team of Art of living teachers & volunteers.

From The Art of Living, a team of teachers and Volunteers led by Maheshwari Narayanan, conducted a 4 days' workshop on Youth Health and Mind Management for our 1st year engineering students.

The schedule was as below:

22nd March, Monday 8.00-9.00am A & B division

23rd March, Tuesday 8.00-9.00am C & D division

24th March, Wednesday 8.00-9.00am E & F division

25th March, Thursday 8.00-9.00am G , H & I division

Total of 440 students participated in the workshop.

Every day the webinar would start at 8am with some Practical wisdom to remain Relaxed and Confident and handle stress as a student. This was followed by some games, to create awareness about health and mind management. Students would then get into breakout room with one speaker , volunteer and 10-12 students , where the speaker would teach how to handle stress with help of Breathing techniques. Bhastrika Pranayam was demonstrated followed by Meditation. The speakers would one to one answer the questions the students had.

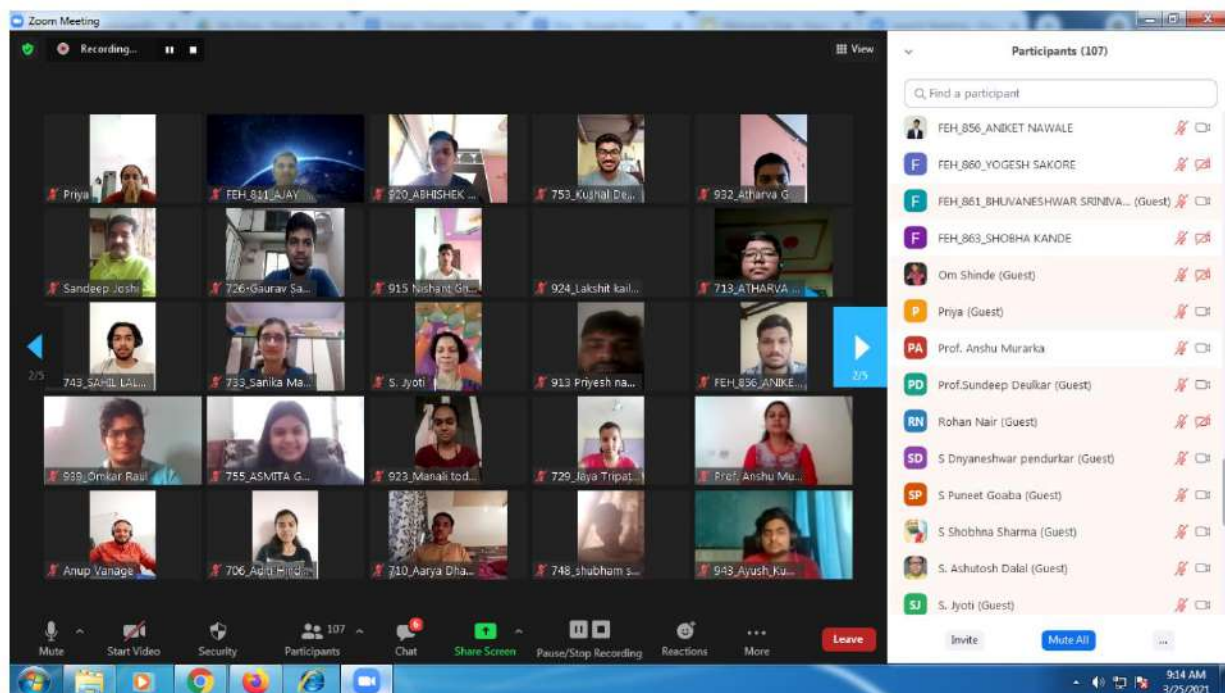

Workshop on Youth health and Mind Management

Unnat Bharat Abhiyan Activity



- Webinar on “ Insights on National Education Policy –2020 “ by Mr. Mandar Shinde On 23rd September 2020 : Conducted Webinar “Insights on National Education Policy – 2020“ by Mr. Mandar Shinde. Around 150 participants as faculties, students and various industrial people attended it.



- Organized Quiz in HINDI, ENGLISH, MARATHI related to NEP-2020: Circulated brochure regarding NEP -2020 to all faculties and students. Around 1000 people received brochure regarding NEP -2020. Quiz Brochure in HINDI, ENGLISH, MARATHI. Around 500 people attempted quiz in all three languages. Participation certificate has been provided to people

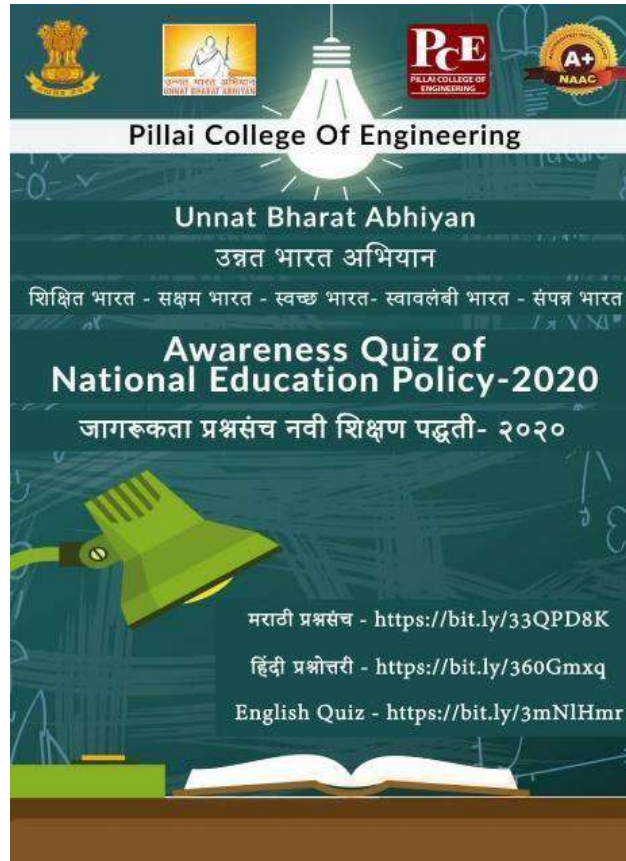



- Name of adopted villages
 1. Shirdhon
 2. Nere
 3. Ritghar
 4. Wakdi
 5. Chikhale

Notable Achievements

Toycathon 2021

PCE IIC was selected as a Nodal center to host the TOYCATHON 2021 in association with different Ministries under Government of India. The GRAND FINALE of the hackathon was conducted in online mode from 22nd to 24th June 2021. There were 14 participating teams allocated to the PCE Nodal center which were mentored and evaluated by a panel of 10 evaluators from various institutes from all over the nation. The participating teams designed various toys for different age groups. The PCE's Toycathon was Inaugurated in the presence of Chief Guest Mr. Dharam Vir, IAS, President, Society for Promotion of Science & Technology and Guest of Honor Mr. Suneet Sabale, Founder, Director and CEO, Brainiac IP Solution, Principal PCE, Dr. Sandeep Joshi, Evaluator, Faculty, Participants and Team Members. Out of the 14 teams allocated to PCE Nodal center, 6 teams got qualified for the power judging round. PCE was also nominated as a center to conduct the power judging round on 24th June 2021. The event was concluded by a valedictory function in the presence of honourable chief guest Dr. Suresh K. Ukrande, Assoc. Dean Science and Technology, UoM, and Guest of Honour Dr. Mathew T. Joseph, Principal PHCET, Dr. Sandeep Joshi, Principal PCE, evaluators, participants, faculty and team members. There were 6 winning teams from the teams allocated to Nodal Centre Pillai College of Engineering. Also, the team allotted to PCE for the power judging round won the Toycathon 2021.



The banner features logos of various government departments and organizations at the top, including Ministry of Women and Child Development, Ministry of Information and Broadcasting, Ministry of Education, Department for Promotion of Gender and Equal Opportunity, Department of Science and Technology, IISME, Ministry of Textiles, Ministry of Education's Innovation Cell, and PCE. The main text reads: "Toycathon 2021 Mahatma Education Society's PILLAI COLLEGE OF ENGINEERING Digital Edition 22nd - 24th June 2021 GRAND FINALE Result Declaration on 26th June 2021". The banner is decorated with colorful elephants and various toy designs.

[f /mhrdInnovation](https://www.facebook.com/mhrdInnovation)
[@mhrd_innovation](https://www.instagram.com/mhrd_innovation)
[@aicte_india](https://www.twitter.com/@aicte_india)
[y /mhrdInnovationcell](https://www.youtube.com/channel/UCmhrdInnovationcell)
[f /pillaicollege](https://www.facebook.com/pillaicollege)
[i /pillaicollege](https://www.instagram.com/pillaicollege)
[@pillaicollege](https://www.twitter.com/@pillaicollege)



A Proud Moment for Everyone Associated
 Mahatma Education Society's
PILLAI COLLEGE OF ENGINEERING
will serve as Nodal Centre for



Toycathon-2021

by Government of India

22nd – 24th June 2021

Let's Get Our Acts Together to
Make it a Grand Success

Participating Ministries



[f /pillaicollege](https://www.facebook.com/pillaicollege)

[@pillaicollege](https://twitter.com/pillaicollege)

[/pillaicollege](https://www.instagram.com/pillaicollege)

[/PillaiGroupOnline](https://www.youtube.com/channel/UC...)



Inauguration Event Flyer



Valedictory Event Flyer



PCE
PILLAI COLLEGE OF
ENGINEERING

Mahatma Education Society's
PILLAI COLLEGE OF ENGINEERING
Nodal Centre for Grand Finale of Toyathon 2021

TOYCATHON
2021

Focused on Indian Culture and Ethos to Restore
Traditional Indian Games

**"A step towards making India Atmanirbhar in the toy sector and also
increasing the presence of Bhartiya toys in the global market"**
- Shri. Narendra Modi

INTERACTION
LIVE
11.00 AM.

Hon. Prime Minister Shri. Narendra Modi

Live Session by Honorable PM

Few Screenshots of the event:

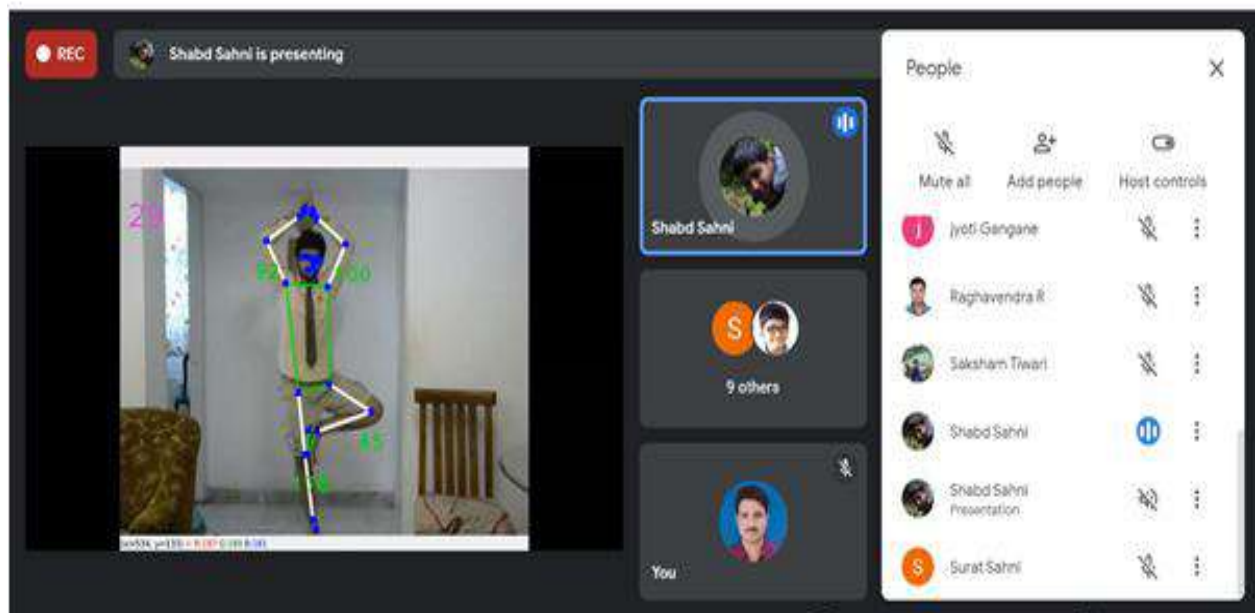

Golden Jubilee Talk Series on “National Education Policy..... The Road Ahead”

Internal Quality Assurance Cell of Pillai college of Engineering, New Panvel has organised an expert talk on “National Education Policy....The Road Ahead” in the Golden Jubilee Talk Series on 28th October, 2020 at 3.00 pm. The distinguished speaker for the talk was Dr. R Manoj Kumar, Joint Secretary, UGC. The session was inaugurated in the presence of the expert, Dr. R Manoj Kumar Sir, Chairman and CEO Mahatma Education Society, Dr. K. M. Vasudevan Pillai Sir, Secretary, MES, Dr. Daphne Pillai Madam, Chief Operating Officer, MES, Dr. Priam Pillai Sir, Principal PCE, Dr. Sandeep Joshi Sir, Disguised Guests, all Heads of Departments and faculty members. Dr. Sandeep Joshi, Principal PCE, briefed the attendees with the organisation structure and few of its remarkable achievements. The talk started after a brief introduction of the speaker by IQAC Coordinator, Dr. Monika Bhagwat.



The poster features a dark green background with a gold and red border. At the top left is the PCE logo and text: "Mahatma Education Society's Pillai College of Engineering (A+ Accredited, 5 Star Rated Institution)". At the top right is a diamond-shaped logo with "50" and "1970-2020". Below this, it says "Internal Quality Assurance Cell Presents" and "Distinguished Speaker" in a cursive font. A circular portrait of Dr. R. Manoj Kumar is on the right. The main title "The Golden Jubilee Talk Series" is in yellow, followed by the topic "National Educational Policy...The Road Ahead" in white. Below that is the speaker's name "Dr. R. Manoj Kumar" and title "Joint Secretary, UGC" in white. The date and time "WEDNESDAY, 28TH OCTOBER, 2020 AT 3 PM" are in white. At the bottom are logos for PCE, PCEACS, PICA, PIMSAR, and the Pillai signature.

Mahatma Education Society's
Pillai College of Engineering
(A+ Accredited, 5 Star Rated Institution)

Internal Quality Assurance Cell
Presents

Distinguished Speaker

The Golden Jubilee Talk Series

"National Educational Policy...The Road Ahead"

Dr. R. Manoj Kumar
Joint Secretary, UGC

WEDNESDAY, 28TH OCTOBER, 2020 AT 3 PM

PCE
PILLAI COLLEGE OF
ENGINEERING



PCEACS

PICA

Pillai Institute of Management
Studies & Research
PIMSAR

Pillai





The new policy replaces the previous National Policy on Education, 1986. The policy is a comprehensive framework for elementary education to higher education as well as vocational training in both rural and urban India. The talk was organised to provide an insight into the policy by the expert of the field. Dr. R Manoj Kumar explained about the National educational policy starting from the older education policies to the challenges to be faced while implementing the new policy. He highlighted the key features such as no hard separation in arts, science streams, flexibility in choice of subjects, multilingual approach, provision for multiple entry and exit points with appropriate certification, academic bank of credit, light but tight regulation through one single regulation body, recommendations for online and digital education and adult education to name a few. The talk was very informative. About 150+ faculty members have attended the talk. All the queries were addressed by the speaker during the Q/A session after the talk.



Dr. R. Manoj Kumar

Joint Secretary, UGC

- ❖ Ph.D. Guwahati University.
- ❖ Teacher & Educational Administrator since 23 years.
- ❖ Recipient of the ICSSR Doctoral Teacher Fellowship.
- ❖ Participated in number of seminars, conferences, workshops and courses across the country.
- ❖ Published number of Research Papers.
- ❖ Active executive member and office bearer of the **University Teachers' Association**.
- ❖ Held position of **General Secretary** and **Vice President**.
- ❖ At UGC, Delhi, he was mainly involved in **coordination & policy planning** for higher education.
- ❖ Contributed to educational reforms, innovation, curricular design, policy formulation in various capacities.
- ❖ Worked in 5 regional offices of UGC at Pune, Hyderabad, Kolkata, Guwahati and Bhopal.
- ❖ Served as **Member Secretary, National Council of Rural Institutes**.
- ❖ Active in **Disability Advocacy**, Associated **National Human Rights Commission** for the implementation of Disability Rights.
- ❖ Table Tennis player and led his University Team in the South Zone Inter University Championship **twice**.

Pillai Institute of Management Studies & Research

Dr. R Manoj Kumar's Introduction



Expert for the Talk

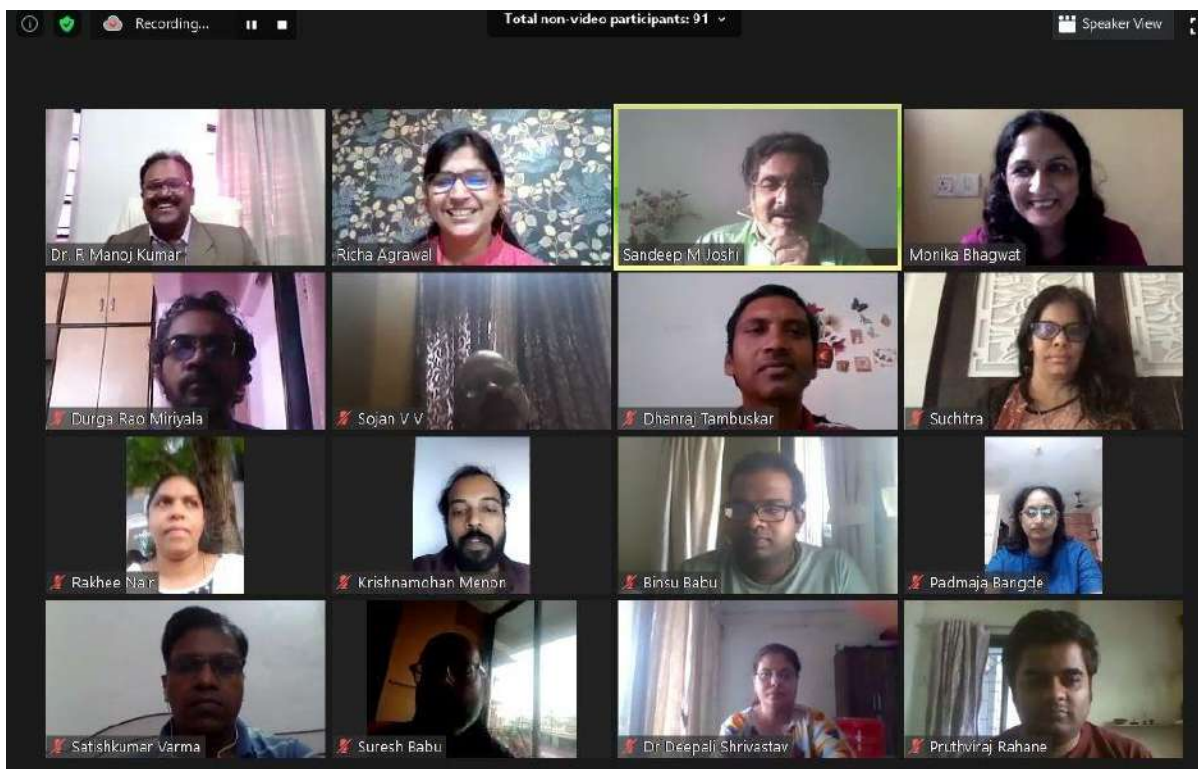

Screenshot of few of the participants attending the talk

National Web Conference - Global Competitiveness of Indian Mineral Industry

Mining Engineers' Association of India (MEAI)- Mumbai Chapter, along with Pillai College of Engineering, organised a National Web Conference titled Global Competitiveness of Indian Mineral Industry, sub titled Exploration to Capital Market, from 05th September to 12th September, 2020. This conference was led under the leadership of Mr. Ravi Chandran Raj, MEAI Mumbai Chapter Founder Chairman, with guidance and support from Dr. Sandeep M. Joshi, Principal, Pillai College of Engineering, who is also the Director of MEAI Skill- Tech Centre at PCE campus.

The conference was conducted on 4 days, with 2 sessions per day. Top professionals, seniors and management leaders of mining industry, from India and abroad, were the key note speakers for this conference. There were around 500 attendees for this conference.



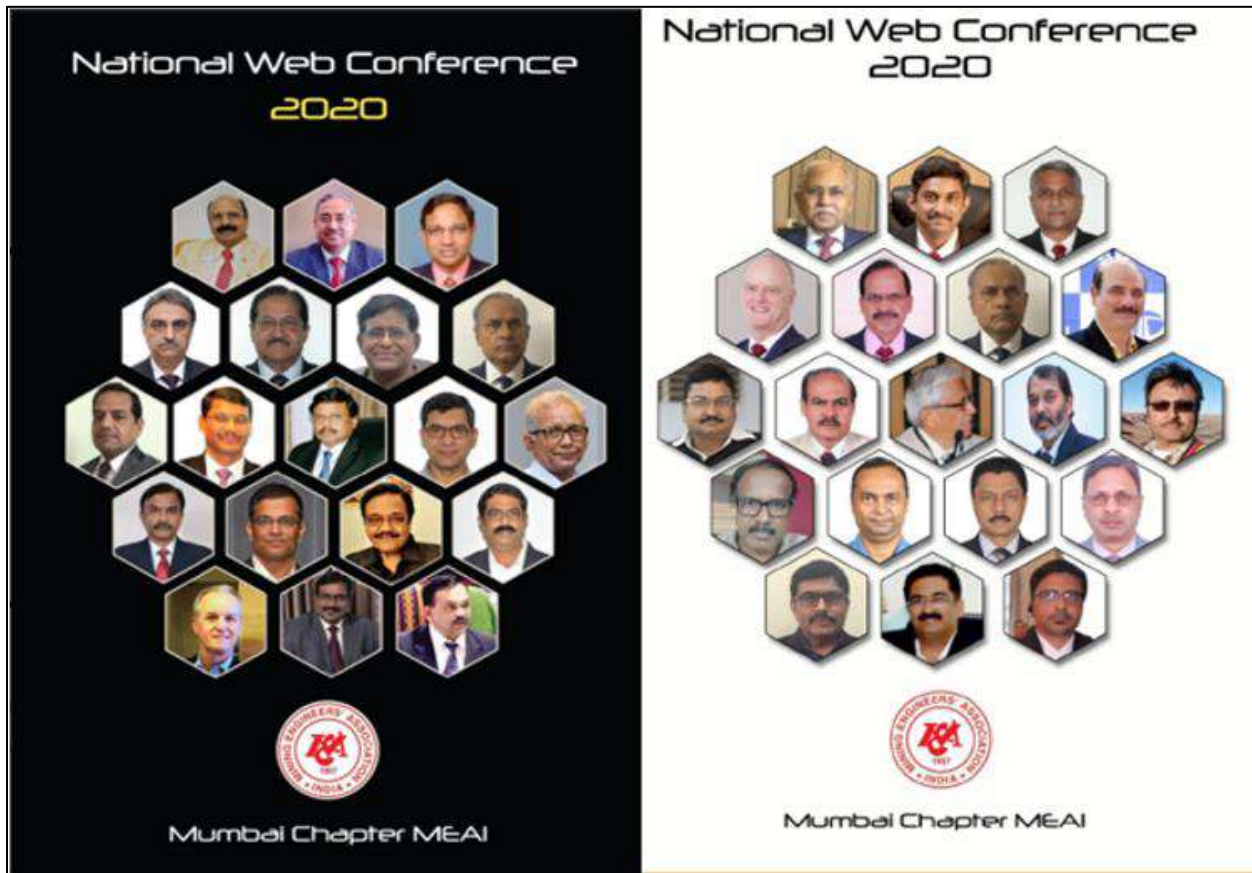

Distinguished Guests & Speakers for the Conference

<p>Global Competitiveness of Indian Mineral Industry</p>	<p>Exploration To Capital Market</p>		
<table border="0" style="width: 100%;"> <tr> <td style="width: 50%; vertical-align: top;"> <p><u>Official Host, Web Tech Studio Admin Team</u></p> <ol style="list-style-type: none"> 1. Dr. Sandeep M. Joshi (Official Host) 2. Dr. Arun Pillai (Chief- Web Tech & Admin) 3. Ms. Ruchira Patole (Session Host) 4. Mrs. Deepti Nair (Session Co-Host) 5. Mr. Krishna Mohan Menon (Session Co- Host) </td> <td style="width: 50%; vertical-align: top;"> <p><u>Web Tech Online Team</u></p> <ol style="list-style-type: none"> 6. Mr. Yogesh Kene 7. Mr. Ameet Mehta 8. Mr. Anup Vanage 9. Ms. Florence Simon 10. Mr. Shiva Pradeep M. 11. Mr. Tikaram Varma </td> </tr> </table>		<p><u>Official Host, Web Tech Studio Admin Team</u></p> <ol style="list-style-type: none"> 1. Dr. Sandeep M. Joshi (Official Host) 2. Dr. Arun Pillai (Chief- Web Tech & Admin) 3. Ms. Ruchira Patole (Session Host) 4. Mrs. Deepti Nair (Session Co-Host) 5. Mr. Krishna Mohan Menon (Session Co- Host) 	<p><u>Web Tech Online Team</u></p> <ol style="list-style-type: none"> 6. Mr. Yogesh Kene 7. Mr. Ameet Mehta 8. Mr. Anup Vanage 9. Ms. Florence Simon 10. Mr. Shiva Pradeep M. 11. Mr. Tikaram Varma
<p><u>Official Host, Web Tech Studio Admin Team</u></p> <ol style="list-style-type: none"> 1. Dr. Sandeep M. Joshi (Official Host) 2. Dr. Arun Pillai (Chief- Web Tech & Admin) 3. Ms. Ruchira Patole (Session Host) 4. Mrs. Deepti Nair (Session Co-Host) 5. Mr. Krishna Mohan Menon (Session Co- Host) 	<p><u>Web Tech Online Team</u></p> <ol style="list-style-type: none"> 6. Mr. Yogesh Kene 7. Mr. Ameet Mehta 8. Mr. Anup Vanage 9. Ms. Florence Simon 10. Mr. Shiva Pradeep M. 11. Mr. Tikaram Varma 		
<p>Mumbai Chapter MEAI</p> <p>National Web Conference 2020</p>			
<p>Day 1-4 / Session 1-8 / NWC / A-002 A / Official Host & Admin Studio / Welcome Address</p>			

Conference Organising Team from Pillai College of Engineering

NAAC Approved National Webinar on ‘Assessment and Accreditation process of NAAC’

A One Day NAAC Approved National Level Webinar on “Assessment and Accreditation process of NAAC” was organised by IQAC, Pillai College of Engineering, New Panvel on 28th August, 2020. Inauguration function was graced by Chief Guest Prof. R. D. Kulkarni, Hon'ble Pro Vice-Chancellor, University of Mumbai and Guest of Honour Dr Ganesh Anant Hegde, Adviser, NAAC.

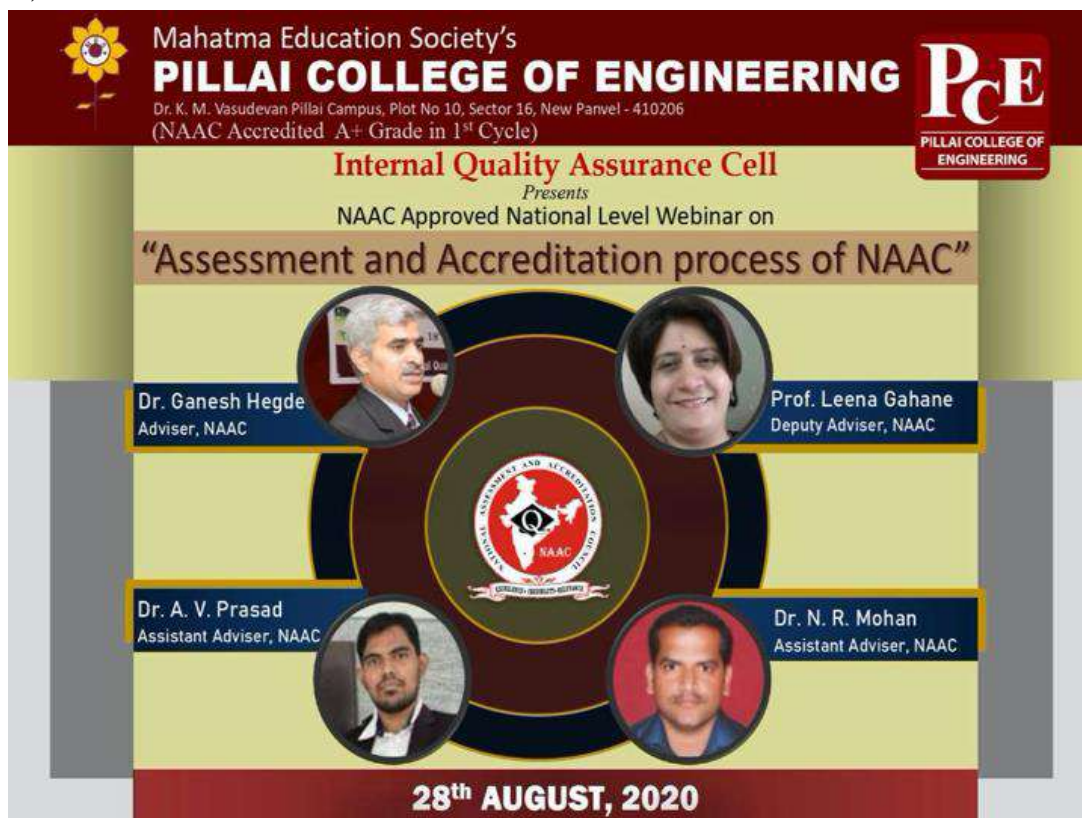

The resource persons for the session were, Dr. Ganesh Anant Hegde, Dr. Leena Govind Gahane, Dr. A V Prasad and Dr. N. R. Mohan. Dr. Ganesh Anant Hegde, Adviser, NAAC has talked about Understanding NAAC A & A process and Paradigm shift in teaching and learning after post pandemic. Prof. Dr. Leena Govind Gahane, Deputy Adviser, NAAC. Madam has given insights of the role of IQAC in Enhancing & Maintaining Quality in higher education. Dr Prasad has discussed in detail about the parameters of an effective DVV process. And Dr. N. R. Mohan, Assistant Adviser discussed about importance of preparation and submission of AQAR & FAQ. Valedictory function was graced by the presence of Dr Priam Pillai, COO, Mahatma Education Society. The Chief Guest for the fuction was Dr. Suresh Ukarande, Associate Dean, Faculty of Science & Technology, University of Mumbai. He shared his view on NAAC Accreditation process and responsibility of a teacher during content delivery in post pandemic era. Guest of

Honour, Prof. Dr. Leena Govind Gahane, elaborated the responsibility and contribution of a teacher in the overall development of the students and making them a good citizen. 1200+ participants from all over India attended the webinar through Zoom meet and MES YouTube Channel. All the participants have actively participated in all the sessions.



Chief Guest for Inaugural function



Inauguration addressing Principal Dr. Sandeep Joshi, Chief Guest: Prof. R. D. Kulkarni, Hon'ble Pro Vice-Chancellor, University of Mumbai, and Guest of Honour: Dr. Ganesh Anant Hegde, Adviser, NAAC

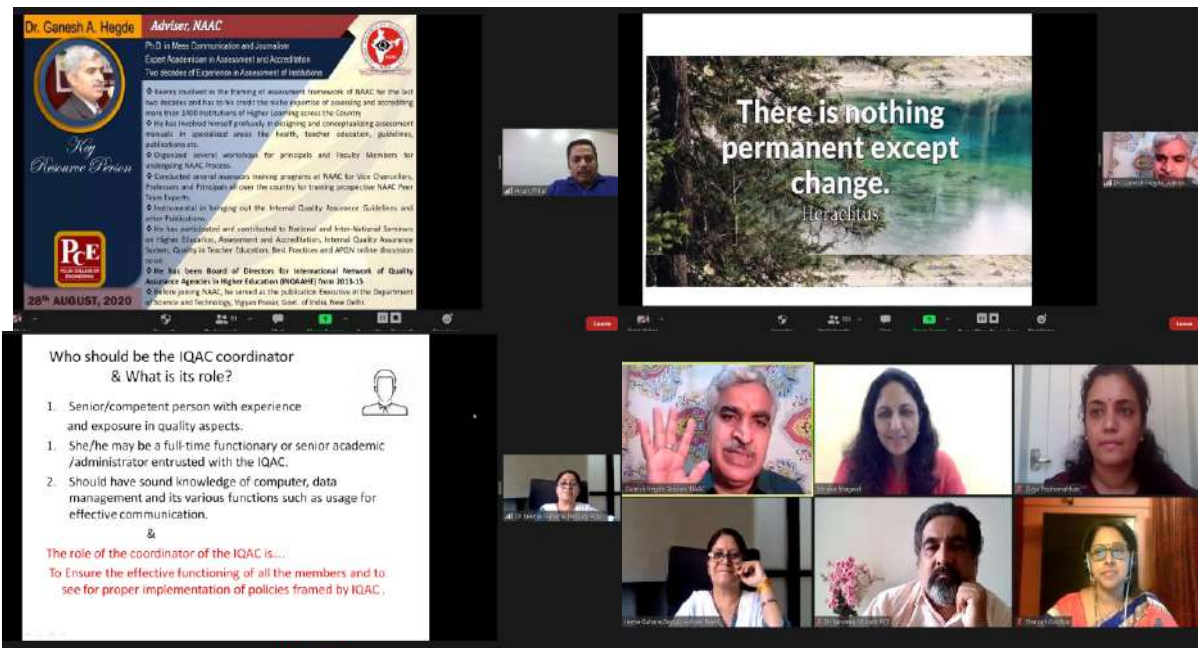

Session 1 by Dr. Ganesh Anant Hegde, Adviser, NAAC and Prof. Dr. Leena Govind Gahane, Deputy Adviser, NAAC

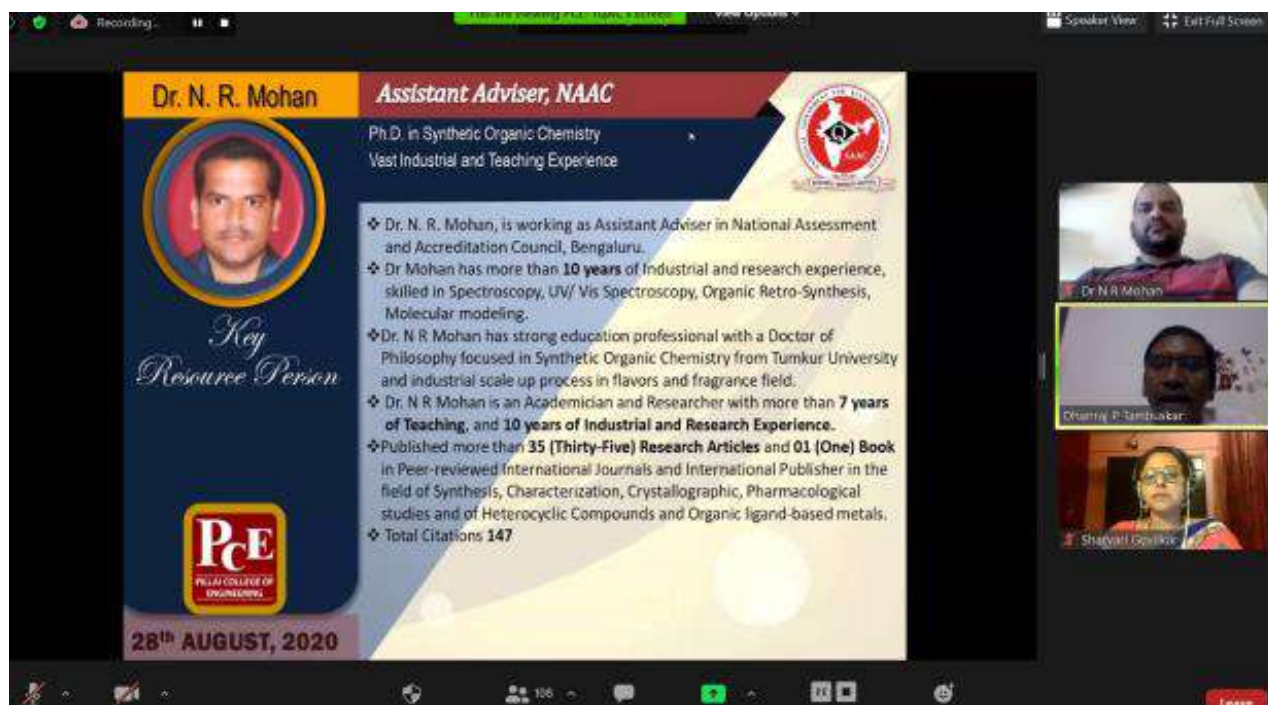

Session 2 by Dr. A V Prasad, Assistant Adviser, NAAC and Dr. N. R. Mohan, Assistant Adviser, NAAC



Valedictory function Chief Guest - Dr. Suresh Ukarande, Associate Dean , Faculty of Science & Technology, UOM and Principal KJSIET, Mumbai and
 Guest of Honour : Prof. Dr. Leena Govind Gahane, Deputy Adviser, NAAC



Webinar participants with Organising Team

Event Brochure:

Introduction

Pillai College of Engineering (PCE), New Panvel is organizing a NAAC approved National Level Webinar on "Assessment and Accreditation process of NAAC". This webinar is intended to help the participants to understand NAAC's Accreditation Framework. The webinar focuses on understanding the benefits of accreditation and the systematic process to sustain quality in Higher education institutes. It will familiarise the participants about the role of various stakeholders in quality improvement in the post accreditation scenario. Besides this, it will also introduce the participants to Paradigm Shift in the Teaching and Learning process.

About PCE

PCE is a flagship institute of Mahatma Education Society, which began its endeavor of Education in 1970. PCE was established in the year 1999 in New Panvel, largely, to provide a world class engineering education to students of rural Maharashtra. PCE is affiliated to University of Mumbai, approved by All India Council for Technical Education and accredited by National Board of Accreditation. Apart from 6 Undergraduate programs, it offers 5 postgraduate programs and has received a research center status for the department of Mechanical Engineering, Computer Engineering and Information technology.

Patrons

- **Dr. K. M. Vasudevan Pillai**
- **Dr. Daphne Pillai**
- **Dr. Priam Pillai**
- **Mr. Franav Pillai**
- **Prof. Munawira Pillai**

Advisory Board

- **Dr. Sandeep M. Joshi**
Principal
- **Dr. Prem S. Goyal**
Dean Research & Development
- **Dr. Arun Pillai**
Head, Applied Science Mathematics & Humanities
- **Dr. Divya Padmanabhan**
Head, Automobile Engineering
- **Dr. Rajendra Khade**
Head, Electronics & Computer Science Engineering
- **Dr. Avinash Valdy**
Head, Electronics & Telecommunication Engineering
- **Dr. Satishkumar Varma**
Head, Information Technology
- **Dr. Dhanraj Tambuskar**
Head, Mechanical Engineering
- **Prof Pragnesh Shah**
Director Admissions

Program Coordinators

- **Dr. Sharvari Govilkar**
IQAC Coordinator
Head, Computer Engineering
- **Dr. Monika Bhagwat**
IQAC Co-coordinator
Electronics & Telecommunication Engineering

Resource Persons



Dr. Ganesh Anant Hegde,
Adviser, NAAC



Prof. Dr. Leena Govind Gahane,
Deputy Adviser, NAAC



Dr. A V Prasad,
Assistant Adviser, NAAC



Dr. N. R. Mohan, Assistant
Adviser, NAAC

Program Content

- Understanding NAAC, A & A process & Paradigm shift in teaching and learning after post pandemic.
- The role of IQAC in Enhancing & Maintaining Quality in higher education
- Understanding the parameters of an effective DVV process.
- Importance of preparation and submission of AQAR & FAQ

Who Should Attend

Directors, Principals, IQAC Coordinators and Faculty Members of HEI's who have already secured the Accreditation Status from NAAC or planning to go for such accreditation or waiting for Peer Team Visit.

Mode of Program

The Webinar will be conducted on online mode followed by Q&A session and Quiz. E-certificates will be issued to all participants who have attended all sessions.

Organising Team

Dr. Richa Agrawal
Department of Mechanical Engineering
Mobile: +91-9619208203
Email: ragrawal@mes.ac.in

Prof. Rupali Nikhare
Department of Computer Engineering
Mobile: +91-9769488878
Email: rnikhare@mes.ac.in

Prof. Suchitra A. Patil
Department of Electronics & Telecommunication Engineering
Mobile: +91-9819226982
Email: spatil@mes.ac.in



Mahatma Education Society's
Pillai College of Engineering
(NAAC 'A+' Grade in 1st Cycle)
presents

NAAC Approved
National Level Webinar on
**"Assessment and
Accreditation process of
NAAC"**
28th August, 2020

Organized by

Internal Quality Assurance Cell
Pillai College of Engineering
Dr. K. M. Vasudevan Pillai Campus,
Sector 16, New Panvel, Navi Mumbai,
Maharashtra, 410206
Web site: www.pce.ac.in



Mahatma Education Society's
Pillai College of Engineering, New Panvel

NAAC Approved
National Level Webinar on
**"Assessment and Accreditation
process of NAAC"**
28th August, 2020

Link for Online Registration

<https://forms.gle/VedfY4ZLG4J5vi2B8>

Last Date of Registration :

27th August, 2020 till 5.00pm

Timings

10.00 am to 5.30 pm

Webinar Fees : Free

For Queries Contact

Dr. Sharvari Govilkar

Mobile.: +91-9819261265

Dr. Monika Bhagwat

Mobile.: +91-9820277903

Write at: peeiqac@mes.ac.in

MoUs

S.No.	Organisation with which MoU is signed	Date of Signing
1	PIPETECH Engineering Solutions Pvt Ltd	20/03/2021
2	Indian Rubber Manufacturers Research Association (IRMRA)	21/01/2021
3	RFID Tags and Services	21/01/2021
4	Saintiant Technology	09/09/2020
5	MEAI Skill Tech Centre	18/06/2020



MoU with RF Tags and Services, Thane



MoU with PIPETECH Engineering Solutions Pvt Ltd an ISO 9001-2015 Company

Copyrights & Patents Received

Sn	Authors	Title of work	Description of the work	Registration No .	Year / Month
1	Avinash Vaidya	HIGH GAIN WIDEBAND FPC ANTENNA	Government of India Patent	341129	10/07/2020
2	Amol Kharat Blessy Varghese Ranjita Chalke Aju Palleri	COPYRIGHT - PCE AMS: WEB APP FOR MANAGEMENT OF VARIOUS ACADEMIC ACTIVITIES (HTTP://AMS.PCE.AC.IN)	Literary/ Dramatic Work	L-104038/2021	02/06/2021
3	Dhiraj Amin Dr. Sharvari Govilkar Dr. Monika Bhagwat	ASK: WEB APP FOR DIGITAL MENTORING (HTTP://ASK.PCE.AC.IN)	Literary/ Dramatic Work	L-103822/2021	28/05/2021
4	Shubhangi Chavan Dr. Sharvari Govilkar	MARATHI PART OF SPEECH RULES TO AVOID TAG AMBIGUITY	Computer Software Work	SW- 14559/2021	21/05/21
5	Dr.Sushopti Gawade	COPYRIGHT received for GRAD: Grape Disease Management Web Interface	Literary/ Dramatic Work	L-96105 / 2020	26/10/20
6	Dr. Sushopti Gawade	COPYRIGHT received for DATASET: DataSet creation for Students Learning Habbits during COVID19	Literary/ Dramatic Work	L-101051 / 2021	30/03/21

Funding and Research Grants

1. **Dr. Avinash Vaidya & Dr. Arun Pillai** - AICTE grant of Rs. 1,00,000/- under the scheme for Promoting Interests, Creativity and Ethics among Students (SPICES) to PCE NATURE CLUB
2. **Varunakshi Bhojane** - MODROB grant of Rs. 888235/- received from AICTE for Modernization of Artificial ad Machine Learning Lab
3. **Dr. Deepali Shrivastava** - UGC DAE CSR Mumbai funded Project of Rs. 1,35,000/- Sanction of CRS titled “Study of Dielectric and Structural Properties of polyimide-nanocomposite films”
4. **Dr. P. S. Goyal** - Sanctioned Research Project of Rs 6.39 Lakhs for 3 years for project titled “Study of correlation between the structure and the water permeability of nanocomposites membranes”
5. **D P Tambuskar** - Received AICTE grant of Rs 93000/- for ATAL FDP
6. **Dr Divya Padmanabhan** - Received AICTE grant of Rs 93000/- for ATAL FDP
7. **Dr. Sharvari Gowilkar** - Fund received from PCE management for Computational Infrastructure development for Ph.D. Research Scholars

Faculty Achievements

S No	Name of full time teachers	Details of the achievement in A.Y.20-21
Electronics and Telecommunication Engineering and ECS Department		
1	Avinash Vaidya	Innovation Ambassador , NISP-MoE's innovation cell Result Moderation Committee UoM
2	Tusharika S. Banerjee	Roll of Honour_Mata Surjeet Kaur Viridi Samman
3	Manisha Singh	NPTEL Mentor certificate
4	Ishmeet Singh Riar	Findability Certified Professional: Advanced Data Science and Artificial Intelligence
5	Florence Simon	Certified Data Science specialist
6	Ameet Mehta	Result Monitoring Committee UoM
7	Harsha Ghadge	Innovation Ambassador , NISP-MoE's innovation cell
8	Monika Bhagwat	Reviewer- IEEE Access, Elsevier's ISA Transactions
9		Reviewer- Elsevier's ISA Transactions
10		Session Chair- International Symposium on Industrial Electronics Kyoto Japan, June 2021
11	Suman P.Wadkar	Reviewer and Program Committee member for International conference on Communication, Information and Computing Technology 2021, organised by SPIT, Mumbai, 25-27 June 2021
12		Reviewer for 4th Biennial International Conference on Nascent Technologies in Engineering organised by Fr. C. Rodrigues Institute of Technology, Navi Mumbai, 15th and 16th Jan 2021.
13		Session Chair- International conference on Communication, Information and Computing Technology 2021, organised by SPIT, Mumbai, 25-27 June 2021
Computer Engineering and Information Technology Department		
14	Sharvari Govilkar	Reviewer for the Transactions on Asian and Low-Resource Language Information Processing on 20th July 2020
15		Nominee of internal examiner to conduct Ph. D On-line Viva Voce Examination of Ms. Kuberal S. (Reg. No.2011799203) held at 12.30 pm on 16/09/2020 in Sathyabama Institute of Science & Technology , through Video Conferencing Mode
16		Judge for Annual Project Competition IEEE-CRCE & WIE-CRCE organized by R. CONCEICAO RODRIGUES COLLEGE OF ENGINEERING on 21st march 2021
17		Coordinator for syllabus framing committee for the elective subject Data

		Structure , SEM V Electronics Engg by BOS Electronics Chairman and Principal Fr. Agnel Bandra College April 2021
18		Coordinator for syllabus framing committee for the subject System programming Compiler construction (Theory and lab) SEM VI Computer engineering UOM by BOS Computer Engineering Chairman. April 2021
19		Reviewer for International Journal of Intelligent Computing and Cybernetics on 15th April 2021
20		Reviewer for AICTE Sponsored International E-Conference on ADVANCES IN INFORMATION TECHNOLOGY & RESEARCH organized by VIT, wadala on 31st may and 1 st june 2021.
21		Session chair for AICTE Sponsored International E-Conference on ADVANCES IN INFORMATION TECHNOLOGY & RESEARCH organized by VIT, wadala on 1st June 2021.
22	Varunakshi	Innovation Ambassador , NISP-MoE's innovation cell
23	Bhojane	Received " Excellence Teaching award" in 4th International Conference on " Global Approaches in Natural Resource Management for Smart Agriculture (GNRSA-2020) During Pandemic era of COVID-19 , February 26-28, 2021 , Agricultural Technology Development Society (ATDS), Ghaziabad,UP, India .
24		Received "Appreciation as Leader " in KRITIGYA AGTECH HACKATHON 2020, West Zone Organizing committee, Organized by ICAR- National Agricultural Higher Educational Project
25		Mentor for Avishkar : Maharashtra state Reserch convention 20-21 : Round 1 finalist
26	Satishkumar L Varma	NPTEL Translator for translating the files of the course Information Security-5-Secure Systems Engineering offered by IIT Madras, in Hinid Language 11 Sept 2020.
27		Actively particiated in 'Awards for Excellence in Effective/Innovative Online Teaching' an E-competition organized by the department of IT/CS of Pillai College of Art, Commerce & Science (Autonomous), New Panvel on 14 August 2020.
28	Prashant S Lokhande	Yashwant Sanman Puraskar for work in the field of Cyber Crime and Digital Forensics. Award Confired by Hon. Home Minister Mr Dilip Walse Patil, Govt. of Maharashtra, and Mrs Supriya Sule, MP, Loksabha Dt 19/02/2021
29		Felicitated with emblem (Manpatra) by Commissioner of Police, Navi Mumbai on the eve of Raising Day ceremony,
30	Prashant Nitnaware	Mentor for Avishkar : Maharashtra state Reserch convention 20-21 : Round 1 finalist

31	Gayatri Hegde	Recognized as Institute's Innovation Ambassador for Institution's Innovation Council (IIC)
Mechanical and Automobile Engineering Department		
32	D P Tambuskar	Member, Board of Studies in Mechanical Engineering, University of Mumbai
33		Member, Board of Examination, IIIE
34		Best paper award (1 st Prize) in 63rd National Convention held on 29th & 30th January 2021, organised by IIIE Mumbai Chapter
35		Program Coordinator, Mechanical Engineering UoM Exams
36	Dipesh Jain	Best paper award (1 st Prize) in 63rd National Convention held on 29th & 30th January 2021, organised by IIIE Mumbai Chapter
37	Binsu Babu	Received membership of Dassault Systems Solidworks Champion Program by Dassault Systems 7 th May 2021
38		Globally Certified at the Professional level by Dassault Systems (SOLIDWORKS) 2021
39	Dr Richa Agrawal	Certified Innovation Ambassador by NISP-MoE's innovation cell
40		Semester Coordinator for UoM SEM VII Mechanical Engg. Exams
41	Dr. Gajanan N. Thokal	Semester Coordinator for UoM SEM VI Mechanical Engg. Exams
42	Dr Divya Padmanabhan	Certified Innovation Ambassador by NISP-MoE's innovation cell
43	Ameya Marathe	Semester Coordinator for UoM SEM VI Automobile Engg. Exams
44		Globally Certified at the Professional level by Dassault Systems (SOLIDWORKS) 2021
Applied Science, Mathematics and Humanities Department		
45	Arun Pillai	Quality Controller NPTEL Translation
46	Sachin S Wani	Book Published ,Title:-"Engineering Mathematics-III" for Computer Engineering /Information Technology Branch, Techknowledge Publications
47	Rakhee Nair	Certified IELTS Trainer from British Council, India, Attended British Council's Masterclass for IELTS Trainers Workshop (Part I & Part 2)
48	Malavika Sharma	Invited as speaker for the online webinar series organized by Department of Engineering Sciences, Ramrao Adik Institute of Technology, Nerul Navi Mumbai on June 3 2021
49	Maheshkumar Kudre	Successfully completed participating in the successful Guinness World Record Event "AI-for-India 1.0" -Most users to take an online Computer Programming lesson in 24 hours on April 24th 2021 to April 25th 2021.

---- End of Report----